



# The BEEF

## COW-CALF MANUAL

Purchase the print version of The Beef Cow-calf Manual for \$30.  
Buy it on-line [www.rtw.ca/b420](http://www.rtw.ca/b420)

Alberta

**Purchase the print version of The Beef Cow-calf Manual for \$30.  
Buy it on-line [www.rtw.ca/b420](http://www.rtw.ca/b420)**

# The BEEF COW-CALF MANUAL

**Alberta**  
AGDEX 420/10

**Purchase the print version of The Beef Cow-calf Manual for \$30.  
Buy it on-line [www.rtw.ca/b420](http://www.rtw.ca/b420)**

**Published by:**

Alberta Agriculture and Food  
Information Packaging Centre  
7000 - 113 Street  
Edmonton, Alberta  
Canada T6H 5T6

Production Editor: Dave Orey  
Editor: Caroline King  
Graphic design and page production: Backstreet Communications

Copyright © 2008. Her Majesty the Queen in the Right of Alberta  
(Alberta Agriculture and Food). All rights reserved.

No part of this publication may be reproduced, stored in a retrieval system,  
or transmitted in any form or by any means, electronic, mechanical,  
photocopying, recording, or otherwise without written permission from  
the Information Packaging Centre, Alberta Agriculture and Food.

ISBN 0-7732-6075-7  
Printed in Canada

Copies of this publication may be purchased from:

Publications Office  
**Alberta Agriculture and Food**  
Phone: 1-800-292-5697 (toll-free in Canada)  
(780) 427-0391

or

see our website <[www.agric.gov.ab.ca/publications](http://www.agric.gov.ab.ca/publications)> for information  
about other publications, videos and CD-Roms.



# Table Of Contents

<b>Foreword</b> .....	<b>xiv</b>
<b>Editors and Authors</b> .....	<b>xiv</b>
<b>Acknowledgements</b> .....	<b>xv</b>
<b>First, Second and Third Editions</b> .....	<b>xv</b>
<b>Fourth Edition</b> .....	<b>xv</b>
<b>Photo Credits</b> .....	<b>xv</b>
<b>Introduction</b> .....	<b>1</b>

## SECTION 1

<b>Economics of the Beef Cattle Industry in Alberta</b> .....	<b>3</b>
<b>Nature of the Beef Industry</b> .....	<b>3</b>
Location of Beef Production .....	5
Potential for Future Growth .....	6
The Cattle Cycle.....	7
Globalization of the Beef Market .....	8
Alberta Beef Production in the Future.....	8
<b>Cow-calf Production Economics</b> .....	<b>9</b>
Key Management Areas .....	10
You Have to Measure it to Manage it .....	11
Budgeting and Benchmarking.....	12
<b>Summary</b> .....	<b>16</b>

## SECTION 2

<b>Herd Management</b> .....	<b>17</b>
<b>Brood Cow Management</b> .....	<b>17</b>
Reproductive Efficiency.....	17
Body Condition and Reproduction .....	18
Why Body Condition Score?.....	18
How to Body Condition Score.....	19
Canadian Condition Scoring Scale ..	19
Comparing Canadian and American Systems .....	21
When to Condition Score .....	21

Condition Score and Post-calving Fertility .....	21
Condition Score and Calf Weight.....	22
Condition Score and Feeding Strategies .....	23
Using Body Condition to Manage Feeding Costs.....	23
Using Body Condition for Grouping Cattle by Feeding Needs.....	24
Practical Application of Condition Scoring... ..	24
Learn How to Condition Score .....	24
Use Condition Scores as Management Indicators.....	25
Reproductive Management of the Beef Cow .....	25
Breeding Management .....	25
Rebreeding Management .....	26
Minimize The Postpartum Interval ...	26
Strategies to Improve Reproductive Efficiency .....	27
Ensure Adequate Nutrition .....	27
Shorten The Calving Season .....	28
Track Cow Performance .....	29
Evaluating individual and herd performance.....	29
Handwritten vs. computer records .....	29
GOLD management indicators... ..	30
G for growth of the calves.....	30
O for number of open cows .....	30
L for length of calving season ...	31
D for death loss .....	31
Overall herd performance .....	31
Pregnancy Testing .....	32
Develop A Culling Program .....	32

<b>Developing Replacement Heifers</b> .....	<b>32</b>
Puberty .....	33
Feeding and Breeding Yearling Heifers.....	34
Reducing Calving Difficulty in Heifers .....	34
Selecting Appropriate Bulls for Heifers .....	35
Care of First-calf Heifers .....	35

<b>Selection and Reproductive Management of Bulls</b> .....	<b>36</b>
Bull Selection.....	36
Genetic Merit.....	36
Physical Condition and Health.....	37
Physical Condition .....	37

Feet and leg problems.....	37
Hoof trimming.....	38
Health Problems Affecting Reproductive Organs.....	39
Breeding soundness .....	39
Semen quality.....	40
Scrotal circumference and shape.....	40
Reproductive Management of Bulls .....	42
Breeding Systems and Facilities.....	42
Bull Social Behaviour and Dominance....	42
Nutrition .....	43
Bull-to-cow Ratio .....	43
Disease Risk .....	44
<b>Canadian Cattle Identification Program ....</b>	<b>45</b>
<b>Summary .....</b>	<b>46</b>

## SECTION 3

<b>Genetic Improvement Methods.....</b>	<b>47</b>
<b>First Steps .....</b>	<b>47</b>
Record Keeping.....	47
Setting Your Objectives.....	48
<b>Breeding Principles .....</b>	<b>48</b>
<b>Breeding Systems .....</b>	<b>49</b>
Straight Breeding.....	49
Inbreeding .....	49
Line Breeding.....	50
Outbreeding .....	50
Crossbreeding.....	50
Specific Breed Crossing.....	51
Terminal Crossing .....	52
Rotational Crossing.....	52
Two-way rotation.....	52
Three-way rotation .....	53
Over-three-breed rotation.....	53
Rotation-terminal.....	53
Other Crossbreeding Systems .....	53
Composites .....	53
<b>Evaluating Individual Animals for Breeding Performance .....</b>	<b>54</b>
Expected Progeny Differences (EPD).....	55
Comparing Within a Breed.....	55
Comparing Animals Across Breeds.....	55

<b>Artificial Insemination (AI) .....</b>	<b>56</b>
Advantages and Disadvantages of AI Breeding Programs .....	56
Managing Your AI Program.....	57
Identification and Record Keeping.....	57
Estrous Cycle .....	57
Follicular Phase .....	57
Luteal Phase .....	57
Visible Signs Of Estrus .....	58
Estrous Detection.....	58
Tips For Ensuring Proper Heat Detection .....	58
Estrous Detection Aids.....	59
Insemination Timing.....	60
Factors Affecting Cow Fertility .....	61
Sire Selection .....	61
Semen Quality and Handling.....	61
Brief Summary Of Semen Handling .....	62
Steps Involved In AI .....	62
Ten Point Guide to High AI Conception Rates .....	63
Breeding Pasture and AI Facilities.....	63
Controlled Breeding Programs.....	64
Synchronization Of Estrus and AI At Detected Estrus.....	64
Insemination Without Estrous Detection.....	66
Clean-up Bulls .....	67
<b>Summary .....</b>	<b>67</b>

## SECTION 4

<b>Calf Management from Birth to Weaning .....</b>	<b>69</b>
<b>Calving Management.....</b>	<b>69</b>
Pregnancy and Nutrition.....	69
Stages of Labour.....	70
Stage I: Relaxation .....	70
Stage II: Active Labour.....	70
Stage III: Involution .....	70
Calving Problems.....	71
Problems that Could Occur in Stage I.....	71
Problems that Could Occur in Stage II....	71
Assistance with Calving Difficulties.....	72

Tips on Calving a Cow Having a Calving Problem .....	73
After-calving Problems .....	75
<b>Care of the Newborn Calf.....</b>	<b>76</b>
Calf Not Breathing .....	77
Calf Shivering .....	77
Calf Unable to Find Cow's Teat .....	78
Meeting Colostrum Needs.....	78
<b>Care of the New Suckling Calf.....</b>	<b>80</b>
Processing Procedures .....	80
Disinfecting the Calf's Navel.....	80
Identification of the Newborn.....	80
Castrating the Newborn.....	81
Anatomy.....	81
Castration Methods .....	82
Dehorning the Newborn .....	83
<b>Management of the Suckling Calf .....</b>	<b>84</b>
Branding.....	84
Vaccination .....	84
Castration .....	85
Surgical Castration .....	85
Bloodless Castration .....	86
Dehorning.....	87
Implanting.....	87
How Growth Implants Work .....	87
Implanting Procedures .....	88
Sanitation .....	88
Implanting Site.....	88
Implanting Technique .....	88
Withdrawal Times .....	89
Improved Gains, Feed Efficiency, And Economics.....	89
Other Considerations and Precautions.....	89
Implanting Bull Calves.....	89
Implanting Heifers To Be Used For Replacements.....	89
Reimplanting And Timing Implants .....	90
Impact Of Implants On Our Food Supply .....	90
Creep Feeding.....	91
<b>Weaning and Preconditioning.....</b>	<b>93</b>
Weaning Management .....	93
Preconditioning .....	95
<b>Summary .....</b>	<b>96</b>

## SECTION 5

### Nutrition and Feeding Management..... 97

<b>Nutrients and Nutrient Needs.....</b>	<b>98</b>
Energy .....	99
Energy Value of Forage.....	101
Protein.....	101
Minerals.....	103
Macro-minerals.....	105
Calcium (Ca) .....	105
Phosphorus (P) .....	106
Calcium:phosphorus Ratio .....	107
Calcium-phosphorus mineral supplements.....	107
Magnesium (Mg) .....	108
Potassium (K) .....	109
Potassium:(magnesium + calcium) ratio (dietary tetany ratio) .....	109
Sodium (Na) And Chlorine (Cl) .....	110
Sulphur (S).....	110
Micro-minerals.....	111
Iodine (I) .....	111
Cobalt (Co).....	111
Selenium (Se).....	112
Iron (Fe) .....	112
Zinc (Zn) .....	112
Copper (Cu) .....	113
Molybdenum (Mo) .....	113
Manganese (Mn) .....	114
Other Trace Minerals.....	114
Chelated Trace Minerals .....	114
When To Supplement With Trace Minerals .....	114
Vitamins .....	116
Vitamin A.....	117
Vitamin D .....	118
Vitamin E.....	118
Water .....	118
Water Quality.....	119
Snow as a Water Source.....	120
<b>Nutrient Requirements for Feeding Programs.....</b>	<b>120</b>
Nutrient Content of Various Feeds .....	123
Feed Intake .....	123
Estimates of Dry Matter Intake.....	123

Feeding Management .....	124	Grazing Legume Pastures .....	155
Guidelines for Ration Formulation.....	125	Factors Affecting Bloat In	
Six Steps In Formulating		Animals Grazing Alfalfa.....	156
A Ration.....	125	The plant.....	156
Feed Ration Rules Of Thumb .....	126	The animal .....	157
Managing Feed Wastage.....	126	Grazing Management Tips	
Body Condition of Cows.....	128	To Reduce Bloat .....	157
Cold Weather Feeding		Grazing Systems .....	158
and Impaction.....	128	Grazing Management Principles ...	159
Winter Feeding of Cows and		Class of cattle .....	159
Replacement Heifers.....	129	Number of cattle .....	159
Winter-feeding Rations For		Grazing distribution .....	159
Cows In Mid Pregnancy.....	129	Carryover .....	160
Winter-feeding Rations For		Grazing selectivity.....	161
Cows In Late Pregnancy .....	131	Timing of grazing .....	161
After-calving Lactation Rations		Frequency of grazing .....	161
For Cows.....	131	Determining Stocking Rates .....	161
Winter-feeding Of Replacement		Pasture condition classes.....	162
Heifer Calves.....	132	Sample calculations for	
Feeding of Backgrounding		determining stocking rates....	163
and Finishing Cattle.....	133	The modern cow and	
Backgrounding Programs .....	133	calf – adjusting for size .....	163
Type And Weight Of Cattle .....	133	Grazing Management And	
Delivery Date And Target		Poisonous Plants.....	164
Sale Weight.....	133	Arrow grasses .....	165
Feeding Systems To Optimize		Water hemlock, spotted	
Carcass Quality.....	134	water hemlock (cowbane	
Finishing Programs.....	135	or spotted cowbane).....	165
Starter Rations.....	136	Tall larkspur .....	166
Step-up Rations For Feeder Cattle ...	137	Death camas .....	166
Feed Additives And		Pasture Water Quality .....	167
Growth Promotants .....	140	Pasture Water System Trials.....	167
Regulatory considerations.....	140	Pasture Water Systems Benefits ....	168
Common Feed Additives		Pasture Water System Options.....	168
And Growth Promotants.....	141	Blue-green Algae Poisoning.....	169
Feed Additives And Alternative		<b>Summary .....</b>	<b>169</b>
Beef Production Systems .....	142		
Winter Feeding of Bulls.....	144		
Grazing Management .....	146		
Nutrition on Pasture .....	146		
Cows And Plants .....	146		
Forage Availability .....	146		
Forage Quality.....	147		
Pasture Management .....	149		
Forage Management .....	149		
Seeding And Establishment.....	150		
Forage Nutrient Requirements.....	150		
Weed Control .....	151		
Annual Crops .....	152		
Swath Grazing .....	153		

## SECTION 6

### Animal Health Management..... 171

#### Herd Health and Management Calendar..... 172

Fall, Pre-weaning and Weaning.....	172
Wintering Period .....	173
Pre-calving and Calving Season	
(Late Winter to Early Spring) .....	173
Breeding Season (Early Spring	
to Early Summer).....	174

<b>Beef Cattle Diseases.....</b>	<b>174</b>	Enzootic Bovine Leukosis.....	203
Recognizing Clinical Signs of Disease.....	174	Abscesses.....	203
Clostridial Diseases.....	177	Liver Abscesses.....	203
Malignant Edema.....	177	External Abscesses.....	204
Blackleg.....	177	Toxins.....	205
Other Clostridial Diseases.....	178	Ammonia and Urea Poisoning.....	205
Tetanus (Lockjaw).....	178	Organophosphate and	
Respiratory Diseases.....	178	Carbamate Poisoning.....	205
Shipping Fever.....	178	Reportable Diseases.....	205
Infectious Bovine Rhinotracheitis.....	179	Anthrax.....	205
Histophilosis Disease Complex.....	180	Foot and Mouth Disease (FMD).....	206
Viral Pneumonia of Calves.....	181	Bovine Spongiform Encephalopathy	
Calf Diphtheria (Necrobacillosis).....	182	(BSE) (Mad Cow Disease).....	206
Atypical Interstitial Pneumonia (AIP) ...	182	Minimizing The Risk Of BSE	
Diarrhea Diseases.....	183	In Your Livestock.....	208
Calf Scours.....	183	Brucellosis (Bang's Disease).....	208
Treating Scours.....	183	Miscellaneous Ailments.....	208
Preventing Scours.....	184	Footrot and Other Common	
Factors that increase		Causes of Lameness.....	208
the risk of scours.....	184	Lumpy Jaw (Actinomycosis).....	209
Practices To Prevent Scours.....	185	Wooden Tongue (Actinobacillosis).....	210
Summary Of Practices To Reduce		Pinkeye.....	210
The Risk Of Scours.....	186	White Muscle Disease (WMD).....	211
Coccidiosis.....	187	Navel Ill (Omphalitis).....	212
Johne's Disease (Paratuberculosis).....	188	Mastitis.....	212
Nutritional Problems - Metabolic		Warts.....	213
and Rumens Diseases.....	188	Ringworm.....	213
Bloat (Frothy and Free Gas).....	188	Water Belly (Urinary Calculi).....	213
Grain Overload		Spondylitis.....	214
(Carbohydrate Engorgement).....	191	<b>Administration of Drugs.....</b>	<b>215</b>
Nitrate Poisoning.....	192	Avoiding Antibiotic Residues.....	215
Polioencephalomalacia (Polio).....	194	Methods of Administering Medications.....	216
Grass and Winter Tetany.....	195	Injections.....	216
Milk Fever.....	195	Injection Equipment.....	216
Hardware Disease.....	196	Subcutaneous Injections.....	217
Sweet Clover Poisoning.....	196	Intramuscular Injections.....	218
Vagus Indigestion.....	197	Intravenous Injections.....	218
Impaction.....	197	Sub-conjunctival Injections.....	218
Reproductive Problems and Diseases.....	198	In Drinking Water.....	219
Bovine Virus Diarrhea (Bvd).....	198	In Feed.....	219
Abortions.....	198	Drenching.....	219
Vibriosis ( <i>Campylobacteriosis</i> (C.)).....	199	Stomach Tubing.....	219
Trichomoniasis.....	200	Balling Gun.....	220
Retained Placentas.....	200	Medications in the Uterus.....	220
Prolapsed Uterus.....	201	Tablets.....	220
Prolapsed Vagina.....	202	Uterine Infusion.....	220
Prolapsed Rectum.....	202	Topical and Pour-on Medications.....	220
Cancers.....	202	Intramammary Medication.....	220
Cancer Eye.....	202		



## Caring for Sick Animals ..... 221

Signs of Disease.....	221
Temperature.....	221
Pulse .....	221
Respiration.....	222
Treating Your Own Animals .....	222
Care of Downer Animals .....	223
Zoonoses (Transmissible to Humans).....	225
Biosecurity.....	225

## Summary ..... 227

Health Management Tips that Return the Greatest Profits .....	227
--	-----

## SECTION 7

## Cattle Pests and Their Control ..... 229

### External Pests ..... 229

Warbles (Cattle Grubs, Warble Flies or Heel Flies) .....	229
Biology.....	229
Types of Injury and Economic Loss ....	230
Control.....	231
Cattle Lice .....	231
Biology.....	231
Types of Injury and Economic Loss ....	231
Control.....	232
Mange .....	233
Biology.....	233
Types of Injury and Economic Loss ....	233
Control.....	234
Black Flies .....	234
Biology.....	234
Types of Injury and Economic Loss ....	235
Control.....	235
Horn Flies.....	236
Biology.....	236
Types of Injury and Economic Loss ....	236
Control.....	237
Horn Fly Insecticide Resistance Management .....	237
Mosquitoes .....	238
Biology.....	238
Types of Injury and Economic Loss ....	238
Control.....	238

Houseflies.....	238
Biology.....	238
Types of Injury and Economic Loss ....	238
Control.....	239
Stable Flies.....	239
Biology.....	239
Types of Injury and Economic Loss ....	239
Control.....	239
Face Flies.....	240
Biology.....	240
Types of Injury and Economic Loss ....	240
Control.....	240
Horse Flies.....	240
Biology.....	240
Types of Injury and Economic Loss ....	240
Control.....	241

### Internal Pests..... 241

Gutworms .....	241
Biology.....	241
Types of Injury and Economic Loss ....	241
Control.....	242
Lungworm .....	242
Biology.....	242
Types of Injury and Economic Loss ....	242
Control.....	242

### Parasiticide and Insecticide Products.... 243

Parasiticides.....	243
Anthelmintics .....	243
Endectocides .....	243
Insecticides.....	244
Systemic Insecticides .....	244
Contact Insecticides.....	244
Formulations.....	244
Injectable.....	244
Wettable Powder (WP).....	244
Dusts .....	244
Emulsion, Emulsible Concentrate (EC) ..	244
Application Methods .....	244
Injection .....	245
Livestock Spray.....	245
Mist Spray.....	245
Residual Wall Spray.....	245
Backrubber .....	245
Pour-on.....	245
Spot Treatment.....	246
Dust .....	246

Dust Bags.....	246
Insecticide Ear Tags .....	246
Parasiticide and Insecticide Resistance .....	246
Safety When Applying Pesticides.....	247
Personal Safety .....	247
Animal Safety.....	247
<b>Summary .....</b>	<b>248</b>

## SECTION 8

### Handling Facilities and Fencing..... 249

<b>Handling and Housing Facilities.....</b>	<b>249</b>
Handling Behaviour .....	250
Components of a Handling System.....	251
Holding Corral .....	251
Crowding Pen and Gate .....	251
Sorting Corrals and Gates.....	252
Working Chute and Gates.....	252
Loading Chute and Alley .....	254
Squeeze Chute and Veterinarian Gate ...	255
Scale.....	255
Hospital Pens.....	255
Housing and Shelter .....	255
Design of Handling and Housing Facilities .....	257
Working Area Options .....	257
Steps for Laying Out a Corral Handling System .....	259
Materials .....	259
Location .....	259
Laying Out the Loading Chute .....	260
Laying Out the Curved Working Chute .....	261
Locating the Squeeze .....	261
Laying Out Interior Fences and Gates .....	262
Laying Out a Circular Crowding Tub .....	262
Calculating Materials .....	262
Construction .....	262
Checklist for Corral System Design .....	263
<b>Pasture Fencing.....</b>	<b>264</b>
Types of Fences.....	264

Barbed Wire.....	264
High-tensile Smooth Wire.....	266
Electric.....	266
Fencing Materials .....	269
Posts.....	269
Wire .....	269
Fencing Hardware.....	269
Wire Connections.....	270
Connecting Dissimilar Metals.....	271
Electric Fence Controllers.....	271
Fencing Practice.....	271
Electric Fence Safety and Maintenance.....	272
<b>Summary .....</b>	<b>273</b>

## SECTION 9

### Beef Information on the Internet ..... 275

<b>Canadian Cattle Organization and Association Sites.....</b>	<b>275</b>
<b>Federal and Provincial Government Beef Sites .....</b>	<b>276</b>
<b>United States Government Beef Sites .....</b>	<b>276</b>
<b>Other Cattle Organization and Association Sites.....</b>	<b>276</b>
<b>General Beef Cattle Information Sites .....</b>	<b>276</b>
<b>Range, Pasture and Grazing Information Sites .....</b>	<b>276</b>
<b>Genetics and Breeding Information Sites .....</b>	<b>277</b>
<b>Animal Health Information Sites.....</b>	<b>277</b>
<b>Quality Assurance Programs.....</b>	<b>277</b>
<b>Research and Consumer Information Sites .....</b>	<b>277</b>
<b>Economic and Market Information Sites .....</b>	<b>278</b>
<b>Cattle Facilities and Handling Behaviour Information Sites.....</b>	<b>278</b>
<b>Computer Software for Cattle Operations.....</b>	<b>278</b>

## SECTION 10

### References ..... 279

## List of Figures

Figure 1. Alberta farm cash receipts, by source, 1993 to 2004 .....	4	Figure 22. Protocol A for synchronization of estrus .....	65
Figure 2. Shares of Alberta farm cash receipts, 2004 .....	4	Figure 23. Protocol B for synchronization of estrus .....	65
Figure 3. Alberta and Saskatchewan shares of the Canadian beef cow herd.....	5	Figure 24. Protocol C for synchronization of estrus .....	65
Figure 4. Federally inspected steer and heifer slaughter, by region, 1980 to 2004 .....	6	Figure 25. Protocol D for synchronization of estrus .....	66
Figure 5. Price-inventory cycles .....	7	Figure 26. Protocol E-2 for synchronization of estrus .....	66
Figure 6. Central Alberta feeder steer calf price, fourth quarter .....	9	Figure 27. Protocol F for synchronization of estrus .....	66
Figure 7. Profitability of low-cost vs. high-cost cow-calf enterprises ....	10	Figure 28. Normal position prior to birth ....	70
Figure 8. Management systems and associated cost of production plateaus.....	12	Figure 29. Uterine torsion.....	71
Figure 9. Characteristics of a beef cow with a BCS score of 3 .....	19	Figure 30. Dystocia caused by postural defects of the calf .....	71
Figure 10. Assess the short ribs.....	19	Figure 31. Dystocia caused by the calf's head turned to the side or back...	72
Figure 11. Cow biological-chronological calendar .....	26	Figure 32. Dystocia caused by twins .....	72
Figure 12. Energy requirement for a 590-kg (1,300-lb.) beef cow by stage of production .....	28	Figure 33. Dystocia caused by a hiplock.....	74
Figure 13. Hoof deformities.....	38	Figure 34. Breech presentation.....	74
Figure 14. Parts of the hoof.....	38	Figure 35. Uterine prolapse .....	75
Figure 15. Two-way rotation.....	52	Figure 36. Testicle and associated organs ....	81
Figure 16. Three-way rotation.....	52	Figure 37. Shows proper injection site.....	85
Figure 17. Phases of the estrous cycle.....	58	Figure 38. Positions of surgical incisions.....	86
Figure 18. Kamar marker for estrous detection .....	59	Figure 39. Bloodless castrator – Burdizzo emasculator.....	87
Figure 19. Time to breed for best results.....	60	Figure 40. Correct position of emasculator ...	87
Figure 20. Herringbone AI breeding chute system.....	63	Figure 41. Implanting site .....	89
Figure 21. Pregnancy testing and AI chute containing a “dark box” .....	64	Figure 42. Principle of the first limiting nutrient .....	98
		Figure 43. The partition of energy .....	99
		Figure 44. Priority of use for nutrients .....	121
		Figure 45. Relationship of the nutritive value of feed to factors limiting feed intake .....	123
		Figure 46. Forage availability and demand by cattle .....	147

Figure 47. Changes in the digestibility of leaves and stems of grasses and alfalfa during the growing season.....	148	Figure 72. Solid blocking gate .....	253
Figure 48. Water response functions for grasses (sunlight, temperature and nutrients not limiting) .....	151	Figure 73. One-way gate.....	254
Figure 49. Average precipitation for forage in Alberta .....	152	Figure 74. One-way chain gate .....	254
Figure 50. Typical patterns of pasture production through the grazing season.....	158	Figure 75. Loading alley and chute.....	254
Figure 51. Stocking rate and cow size .....	164	Figure 76. Working area combination – option one .....	257
Figure 52. Water hemlock .....	165	Figure 77. Working area combination – option two .....	259
Figure 53. Tall larkspur.....	166	Figure 78. Working area combination – option three.....	259
Figure 54. Death camas .....	166	Figure 79. Working area combination – option four.....	259
Figure 55. How animals die from bloat .....	190	Figure 80. Loading chute design.....	260
Figure 56. Appearance of dead animal caused by frothy bloat .....	190	Figure 81. How to lay out a circular working chute .....	261
Figure 57. Liver abscesses.....	204	Figure 82. How to lay out a circular crowding tub .....	262
Figure 58. Subcutaneous injection .....	217	Figure 83. Barbed wire field fencing.....	264
Figure 59. Intramuscular injection .....	218	Figure 84. Barbed wire suspension fencing.....	265
Figure 60. A guide to handling livestock at risk.....	224	Figure 85. High-tensile smooth wire (HTSW) pasture fencing.....	265
Figure 61. Life cycle of the warble fly .....	230	Figure 86. High-tensile smooth wire fence layout.....	267
Figure 62. Signs of lice in cattle .....	231	Figure 87. Electrified smooth wire fence ...	267
Figure 63. Areas to inspect for louse infestation.....	232	Figure 88. Permanent electric fence.....	268
Figure 64. Adult black fly .....	234	Figure 89. Types of insulators.....	270
Figure 65. Horn fly.....	236	Figure 90. Wire splices and knots .....	270
Figure 66. The adult stable fly is about 6 mm (0.2 inches) long .....	239	Figure 91. Crimping tool .....	271
Figure 67. Face fly.....	240	Figure 92. Gate handles, connection clamps, cutout switches.....	271
Figure 68. Backrubber .....	245		
Figure 69. Flight zone .....	250		
Figure 70. Fully tapered chute.....	252		
Figure 71. Half-tapered chute .....	252		

## List of Tables

Table 1.	Cost of production comparison worksheet – Southern Alberta ..... 13	Table 21.	Using expected progeny differences to compare two bulls of the same breed ..... 55
Table 2.	Cost of production comparison worksheet – Central Alberta ..... 14	Table 22.	Adjustment factors for estimation of across-breed EPD ..... 56
Table 3.	Cost of production comparison worksheet – Northern Alberta ..... 15	Table 23.	Signs of estrus ..... 58
Table 4.	Effect of per cent calf crop on average weight of calf weaned per cow exposed ..... 18	Table 24.	Industry-standard designating year letters ..... 81
Table 5.	Comparison of the Canadian and American body condition scoring systems..... 21	Table 25.	Growth implants registered for use in Canadian nursing beef calves ..... 88
Table 6.	Effect of body condition score at calving on subsequent reproduction ..... 22	Table 26.	Maximum safe tissue residue levels for growth implants..... 90
Table 7.	Effect of increasing energy (or flushing) on reproductive performance ..... 22	Table 27.	Maximum safe residue levels for naturally produced hormones ..... 90
Table 8.	Effect of body condition on the current year's feed cost and next year's calf weaning weight .... 23	Table 28.	Use factors for different classes of creep feeds ..... 92
Table 9.	Biological cycle of a beef cow ..... 25	Table 29.	Examples of creep rations..... 93
Table 10.	Per cent cows in heat at varying intervals following calving ..... 27	Table 30.	Effect of energy deficiency on reproductive performance of beef cows ..... 100
Table 11.	Conception rate of cows at first service after calving ..... 27	Table 31.	Feeding values of forages as influenced by stage of growth at harvest ..... 101
Table 12.	Effect of body condition on percentage of cows showing heat at various periods after calving .... 28	Table 32.	Degradable (DIP) and undegradable (UIP) protein content of some common feeds in Alberta..... 102
Table 13.	Effect of breed on age and weight at puberty..... 33	Table 33.	Average major mineral analyses of selected Alberta-grown feedstuffs ..... 104
Table 14.	Recommended minimum weights at first breeding..... 34	Table 34.	Maximum tolerable concentrations of some mineral elements toxic to cattle ..... 105
Table 15.	Effect of nutrition on birth weight and calving difficulty in heifers .... 35	Table 35.	Example levels of potassium, calcium and magnesium from feed analysis ..... 109
Table 16.	Relationship between semen quality and conception rate during natural mating ..... 40	Table 36.	Mineral requirements and maximum tolerable concentrations for beef cattle ..... 115
Table 17.	Recommended minimum scrotal circumference for various breeds of beef bulls at different ages ..... 41	Table 37.	Recommended trace mineral levels in salt for Alberta beef cattle ..... 116
Table 18.	Bull-to-cow ratio ..... 43	Table 38.	Approximate total daily water intake of beef cattle ..... 119
Table 19.	Heritability of some traits ..... 48	Table 39.	Average nutrient content of commonly used Alberta feeds .... 122
Table 20.	Be careful with your selection goals..... 48		



Table 40.	Forage and grain dry matter intake guidelines, as per cent of body weight (BW) .....	124	Table 58.	An example of a deferred rotational grazing system.....	160
Table 41.	Feed supplied versus feed consumed and wasted, by delivery system and particle size .....	127	Table 59.	Animal unit equivalents .....	161
Table 42.	Nutrient quality of feed, by delivery system and particle size .....	127	Table 60.	Stocking rates for seeded tame pastures in four pasture condition classes, AUM/acre in Alberta.....	162
Table 43.	Example rations for a 590 kg (1,300 lb.) cow at mid pregnancy ..	129	Table 61.	Effect of cow size, milk production and calf size on energy requirements.....	164
Table 44.	Example rations for a 590 kg (1,300 lb.) cow at late pregnancy ...	130	Table 62.	Summary of vaccination procedures for the control of some infectious diseases in Western Canadian beef herds .....	175
Table 45.	Sample rations for a 590 kg (1,300 lb.) cow producing 8.6 kg (19 lb.) of milk.....	131	Table 63.	Similarities between alfalfa pasture bloat and feedlot bloat ...	189
Table 46.	Target weights for developing replacement heifers.....	132	Table 64.	Method of nitrate analysis and data reporting.....	193
Table 47.	Example rations for replacement heifers gaining 0.8 kg (1.8 lb.) per day .....	132	Table 65.	Summary of levels of supplemental selenium permitted in cattle feeds .....	211
Table 48.	Targets weights for cattle fed for Canadian vs. American markets ...	134	Table 66.	Withdrawal times for some antibiotics, insecticides and vaccines.....	216
Table 49.	Suggested nutrient concentrations for recently weaned calves.....	136	Table 67.	Abbreviations for drug administration methods .....	216
Table 50.	Typical dry matter intakes for calves and yearlings by weight and age .....	137	Table 68.	Minimum working chute width....	253
Table 51.	An example of a step-up program for growing and finishing cattle (per cent dry matter basis).....	138	Table 69.	Recommended dimensions for beef cattle corrals and handling facilities .....	256
Table 52.	Example grower/feeder step-up rations (dry matter basis) and estimated gain.....	139	Table 70.	Guidelines for housing beef cattle .....	258
Table 53.	Example finisher step-up rations (dry matter basis) and estimated gain.....	140	Table 71.	Dimensions for various sizes of single-file working chutes.....	261
Table 54.	Growth implants registered for use in Canadian weaned calves and cattle.....	143	Table 72.	Dimensions for a circular crowding tub with 4-ft. post spacing .....	262
Table 55.	Target weights and daily gains for growing bulls .....	145	Table 73.	Dimensions for a circular crowding tub with 6-ft. post spacing .....	262
Table 56.	Swath grazing at two locations in Western Canada.....	155	Table 74.	Checklist for designing a corral system .....	263
Table 57.	Classification of bloat potential of forages used as pasture .....	156	Table 75.	Spacing for high-tensile smooth wire fencing.....	266
			Table 76.	Wire spacing for electrified fences.....	268

# Foreword

Since 1975, the *Beef Cow-Calf Manual* has offered Alberta cattle producers an overview of the beef cattle industry and technical information on cow-calf production. The manual sets out basic principles in cow-calf management including chapters on economics, herd management, genetic improvement, calf management, nutrition, animal health, pests and facilities.

Cattle have been part of Alberta's history for over 100 years, and we look forward to a dynamic cattle industry over the next 100 years. As technology is rapidly changing, this edition of the manual keeps pace with recent technological advances. I trust cattle producers will find this manual a useful reference.

Rick Frederickson  
Beef Branch Head

# Editors and Authors

This updated edition's Managing Editor is Tennis Marx, Provincial Beef Production Systems Specialist. The section editors and contributors are as follows:

- Dale Kaliel, MSc – economics
- Pat Ramsey, MSc – brood cow management, developing replacement heifers and calf management
- Sandi Jones, MSc – bull management and artificial insemination
- Tennis Marx, MSc, and Erasmus Okine, PhD – cow-calf nutrition and pest management
- Bjorn Berg, PhD – grazing management
- Roy Lewis, DVM – animal health
- Ron Clarke, DVM – calving management and animal health
- Kim Stanford, PhD – genetic improvement
- Karen Schwartzkopf-Genswein, PhD – animal welfare issues
- Wayne Winchell, PEng – handling and housing facilities
- Ali Khan, PhD – cattle pests

# Acknowledgements

## First, Second and Third Editions

The Beef Branch and authors wish to acknowledge the assistance of the divisions, branches, staff and former staff of Alberta Agriculture and Food who made contributions to the 1975, 1981 and 1989 editions of the manual.

## Fourth Edition

The Beef Branch gratefully acknowledges the valuable assistance of Erasmus Okine, PhD, Ron Clarke, DVM, Muhammed Ikram, DVM, Divakar Ambrose, PhD, Karen Phillips, Dave Orey, Carly King, John Gillmore and Sandi Jones, MSc, in reviewing and helping with this manual.

## Photo Credits

The editors and authors wish to thank the following people and organizations for supplying photos for this publication: Duane McCartney, Mark Vitaris, Ken Frederickson, Arvid Aasen, Pat Ramsey, Kim Stanford, Tim McAllister, Neil French, Chris Giffen, Ali Khan, Ross Gould, Linda Hall, Valerie Sowiak, Beth Hoar, Joyce Van Donkersgoed, the Alberta Beef Producers and the Alberta Veterinary Medical Association.





# Introduction

This edition of the *Beef Cow-Calf Manual* has been revised and expanded from the 1989 edition to keep pace with recent information and technological advances.

Whether you are new to the cattle industry or an established beef producer, this manual can provide answers to many of your questions about managing a beef operation. It answers questions like: What level of nutrients do I need in my cows' winter ration? How do I handle a breeched birth? How do I start weaned calves on feed? What are the symptoms of blackleg? What can I do to reduce a cow's louse problem? How do I lay out a working corral? How do my costs of production compare to average costs? It covers many other points to help you fine-tune your operation and increase profitability.

This manual sets out the basic principles of beef management. It is organized into eight main subject areas by chapter. The economics chapter discusses the economic importance of the cattle industry in Alberta, the potential for growth, the cattle cycle and beef production costs. The chapter on herd management describes management of the brood cow, developing replacement heifers and bull

selection and management. The genetic improvement chapter discusses breeding systems, evaluation of breeding animals and artificial insemination. The calf management chapter describes the care and management of calves from calving to weaning.

The nutrition chapter covers nutrients in feed ingredients, nutrient requirements of cattle and grazing management. The animal health management chapter provides a comprehensive overview of the major cattle diseases and their prevention and control, including information on reportable diseases and diseases transmissible to humans. The chapter on pests outlines the biology, type of injury, economic implications and control practices for common external and internal pests of cattle. The handling facilities and fencing chapter provides information on design of corral systems and shelters and pasture fencing materials and methods.

Since information is changing at a faster pace than ever before, the manual lists some Internet websites that provide information on beef cattle topics. More information on a specific topic can be researched by using the Internet. The manual also includes a list of references.







## Economics of the

# Beef Cattle Industry in Alberta

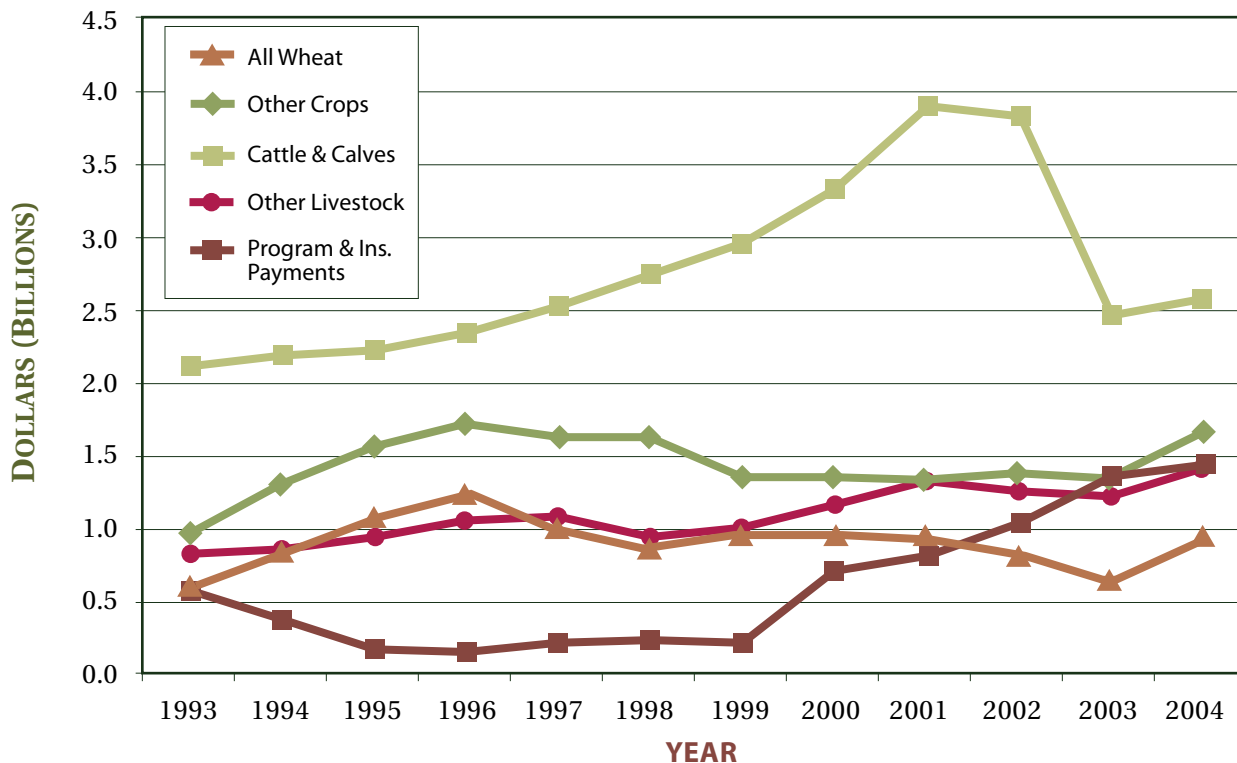
Cow-calf enterprises are typically modest margin and low rate-of-return businesses. Producers need to actively manage their operation's economic performance, along with its productivity performance, to turn a long-term profit.

This chapter discusses Alberta's beef industry, its importance in the Canadian beef industry and the potential for future growth. It explains the cattle price-and-supply cycle and the significance of export markets. It then discusses cow-calf production economics and describes the key factors in short- and long-term profitability. It also provides enterprise analysis worksheets to help you analyse and understand your operation's economic situation.

## Nature of the Beef Industry

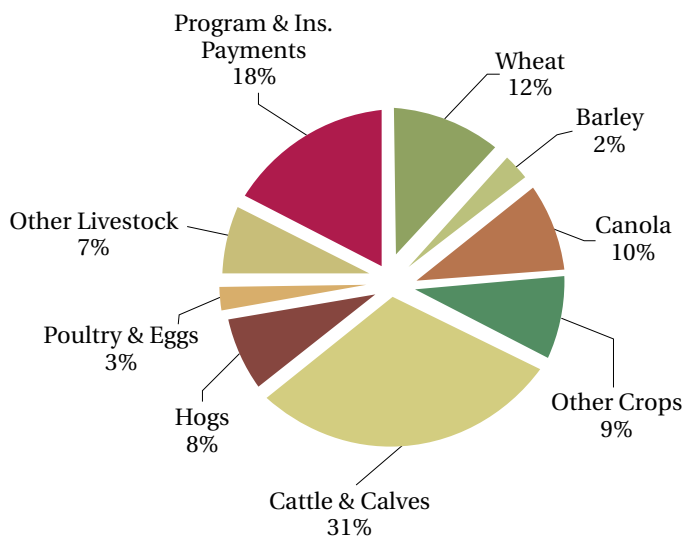
Cow-calf and beef finishing enterprises make up a significant portion of Alberta's agriculture sector. Estimates of Alberta farm cash receipts (Figure 1) indicate the relative importance of the beef industry to Alberta's agriculture sector. Income generated by primary beef production rose from \$2.1 billion in 1993 to \$3.9 billion in 2002. This amounted to about half of Alberta's agricultural cash receipts in 2002. However in 2004, income generated by primary beef production was only about one-third of Alberta's agricultural cash receipts (Figure 2).

Alberta farm cash receipts were affected by successive years of drought in 2001 and 2002. Livestock receipts were affected by the fallout from the discovery of bovine spongiform encephalopathy (BSE) in 2003. Livestock market receipts showed some recovery in 2004, compared with the six-year low in 2003. Direct program payments to Alberta producers totalling \$1.4 billion in 2004 set a new record (Figure 1 and Figure 2), increasing by \$71.3 million (or 5.2 per cent) since 2003.



Source: Alberta Agriculture and Food, Statistics and Data Development Unit

**FIGURE 1.** Alberta farm cash receipts, by source, 1993 to 2004



Source: Alberta Agriculture and Food, Statistics and Data Development Unit

**FIGURE 2.** Shares of Alberta farm cash receipts, 2004

The cow-calf business is well established throughout the province, although the nature of the operations and the resources they use to support the herds vary from region to region.

Alberta's cattle finishing industry has evolved considerably over the past 20 years. There has been a significant increase in the number of large-scale feedlots that specialize in efficiently finishing feeder cattle to slaughter weights.

A growing industry segment lies between the cow-calf and finishing enterprises. It represents a significant business opportunity for producers. This segment involves backgrounding weaned calves, typically on grass and/or higher forage rations, to the entry weights required by the finishing feedlots. The backgrounding industry performs a critical function of spreading out the supply of weaned calves that come to the market in the fall. Weaned calves (450 to 600 lbs.) may go

directly to a finishing feedlot, or to backgrounding lots where they are fed to around 900 lbs. and then sold to finishing feedlots or placed on grass in the spring and sold as yearlings in late August or September to finishing feedlots.

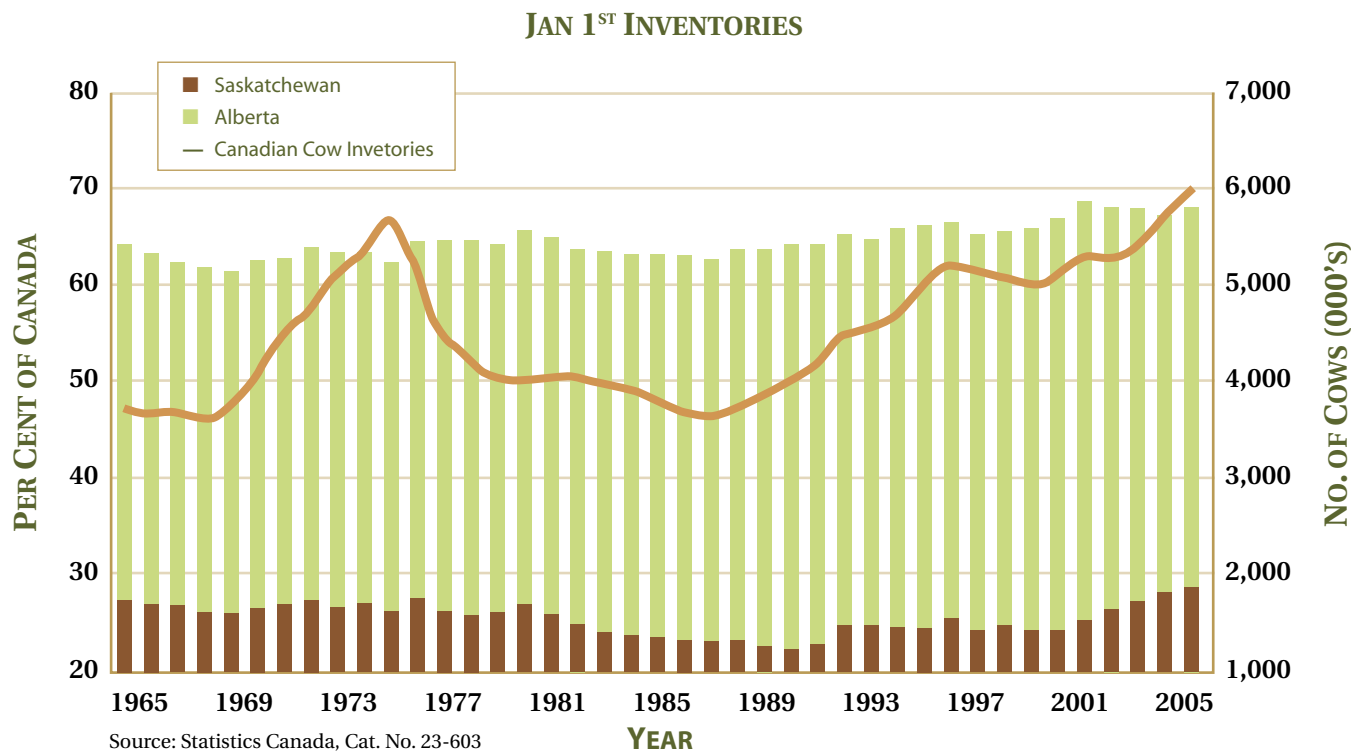
Beef production has historically offered a reasonable opportunity for generating farm profits. Incorporating a beef enterprise into a farm business allows a producer to more effectively use farm assets and diversify the farming operation. Cow-calf and backgrounding operations typically rely more heavily on forage use. This provides an opportunity on many Alberta farms because land less suited to growing cereals and oilseeds can be used to produce forages for winter feeds and grazing.

Diversifying into beef production offers producers added flexibility to offset periods of low income in other commodities. It represents a significant risk management strategy for those producers with suitable land resources and management expertise for producing beef.

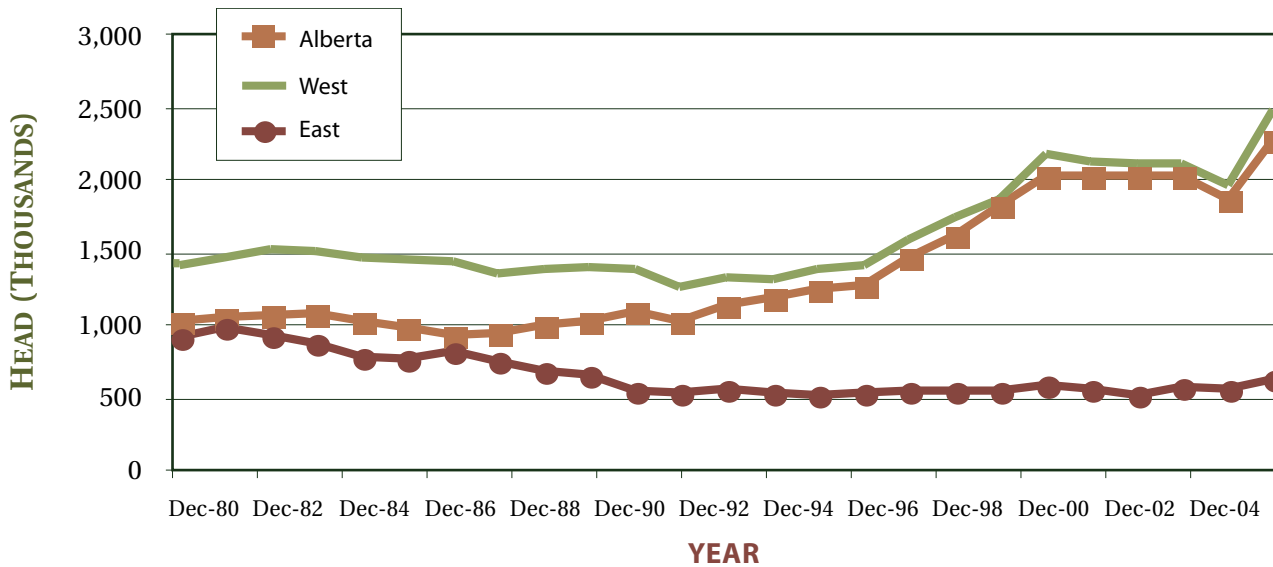
## Location of Beef Production

The Canadian beef herd (Figure 3) stood at roughly 5.9 million cows and bred heifers as of January 1, 2005. Of this total, 2.35 million head (39.2 per cent) were on Alberta farms and 1.71 million head (28.6 per cent) on Saskatchewan farms. With about two-thirds of the country's breeding herd, Alberta and Saskatchewan form the heart of Canada's beef industry.

This point is further solidified by the expansion of feeding and slaughter capacity in the West, from Manitoba to British Columbia (Figure 4). From 1980 to 2000, Alberta's steer and heifer slaughter grew from 44 to 76 per cent of the Canadian total. Alberta's slaughter cattle production almost doubled over this period. The decline in slaughter in 2003 was due to the impact of the first BSE case in Alberta; immediately following the announcement of BSE, the plants stopped slaughtering cattle. The slaughter capacity across Canada increased during the period that the United States' border was closed to Canadian cattle.



**FIGURE 3.** Alberta and Saskatchewan shares of the Canadian beef cow herd



Source: Canadian Beef Grading Agency

**FIGURE 4.** Federally inspected steer and heifer slaughter, by region, 1980 to 2004

## Potential for Future Growth

The size of the global beef market is driven primarily by population, disposable income, consumer preferences (regarding specific product characteristics) and the price of beef relative to alternative products such as pork or poultry. Although population growth is viewed as the major driver for expanded beef consumption, other factors are evolving domestically and globally that can have a marked effect on both the quantities of beef consumed and the value of the products marketed.

As income levels rise in segments of population worldwide, the tendency to consume beef also rises. Focused marketing in areas with long-term economic growth potential translates into proportionately larger advances in beef consumption.

Consumer preferences are becoming more refined regarding convenience, consistency and healthy sources of food. Tailoring beef products for specific market segments holds significant opportunity to add value to the basic beef commodity.

Future expansion depends largely on the rate of expansion of breeding herds and feeding capacity, as well as the industry's ability to create beef products that are desired by consumers. Profitability throughout the beef industry, from both the cost side and the revenue side, will drive industry expansion.

The main routes for expanding beef production are:

- increasing the breeding herd
- importing more feeder cattle from other provinces and the United States
- improving production efficiency

Measures to improve overall productivity and net production efficiency are sometimes costly to implement and the results can take time to come to fruition. Producers need to assess the economic payback to investing in these measures.

Expanded beef production is tied to the land base. Canada is fast approaching the point where an increase in cattle numbers, particularly



for the more forage-dependent cow-calf and backgrounding sectors, will depend on how competitive the industry is with other types of agricultural production. Options for managing within this land constraint include:

- improving the management of existing range and grazing land
- extending the grazing season through such approaches as the use of aftermath, winter grazing of stored forages and swath grazing
- improving forage handling, harvesting and feeding methods
- taking annually cropped land that can no longer earn an economic return and converting it to forage production
- developing the marginal land on existing farms and fringe areas for forage production

Finally, the growth of the beef industry depends on how well producers work with each other, packers, processors and retailers, as they all play a role in getting beef from the farm gate to the consumer's plate. Effective translation of consumers needs back to the farm gate increases the opportunities for creating value and improving profits throughout the industry.

## The Cattle Cycle

North American beef production is subject to a price-and-supply or inventory cycle of about 10 years (Figure 5). The cycle represents the long-run fluctuation in the size of the cattle herd in response to biological and economic forces. The cattle cycle typically consists of a seven-year expansion phase, followed by a three-year contraction phase.

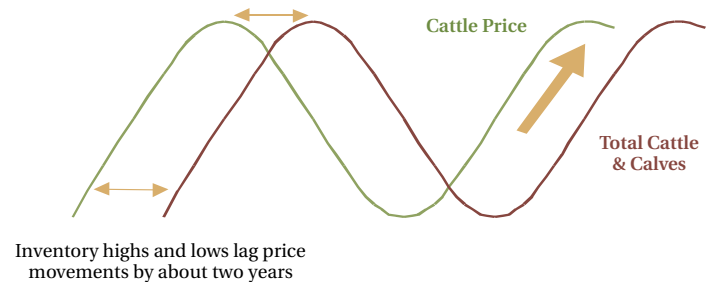
The time lag between the profit opportunity (higher prices) and the production response (herd expansion) causes and perpetuates the cattle cycle. Cattle prices tend to be higher when beef supplies are the smallest. Producers observe higher prices and respond by expanding their herds. Reducing culling rates and retaining a larger percentage of heifers for breeding are the usual methods used to achieve herd expansion. These actions further reduce the beef supply and increase prices. Given

the biology of beef cattle, two to three years pass from the time the expansion decision is made to the time the additional production reaches the marketplace. Eventually, the additional production comes to the market, with further supplies to follow as the upward momentum of the cycle has increased the number of cows and increased production.

In the meantime, consumers have been facing higher beef prices. Their natural response is to reduce consumption and/or switch to alternative meat products. The additional price increase associated with breeding stock retention puts additional upward pressure on prices. Demand is dampened and stocks begin to accumulate. Downward momentum has built on the consumption side.

At this point the decision by producers to gear up production, based on the prices from the previous two or three years, is being translated into additional beef supplies in the market. The upward production momentum, combined with the downward consumption momentum, rapidly drives prices down and reduces profitability. Producers respond to reduced profitability by contracting their herds through culling. This brings additional product onto the market and further depresses prices. The industry's productive capacity is diminished.

Closing this loop, in response to declining beef prices, consumers begin to buy more beef. Upward demand momentum is created at the same time as downward production momentum occurs. The cycle begins again.



**FIGURE 5.** Price-inventory cycles

Predicting how high or low prices will go and when the cycle will turn cannot be done with any degree of certainty. The challenge for cattle producers is to anticipate the price cycles and adjust their production accordingly. Timing herd expansion or contraction to be in concert with the cattle cycle has a profound effect on enterprise profitability. Modern communication systems and the monitoring of worldwide beef supplies should provide part of the information necessary to make decisions. However, many factors affect day-to-day and long-term prices and supplies of beef.

The challenge is for thousands of producers to take the right action at the right time so that the net result is a continuing favourable supply-demand balance. Two key indicators to monitor are the number of cows being slaughtered and the ratio of heifers to steers in the beef kill. This type of market information is available from Alberta Agriculture and Food and from the CanFax information service of the Canadian Cattlemen's Association.

### Globalization of the Beef Market

For the most part, the Canadian and American cattle industries operate reasonably seamlessly in a North American market that services both the continental beef demand and export markets. During more normal conditions, live cattle and beef move relatively freely between the two countries, although some regulatory and trade constraints exist at the Canada-United States border.

*Most cattle are moved by truck.*



The significance of export markets, both the United States and other international markets, to the Canadian beef industry has been driven home by the BSE situation. It also emphasizes how global the beef market has become.

Canada and Alberta are in the beef export business. When confidence in Canadian products is eroded, unfounded or not, export trade virtually stops. Trade restrictions are generally based on:

- perceptions of lower food safety
- danger of transmitting a disease problem to another country's herds

Restrictions, based on these two primary elements, cover the bulk of existing and potential markets. Resumption of trade is typically piecemeal (product-by-product) and can take many years.

### Alberta Beef Production in the Future

There are too many variables in the beef industry to allow long-term projections of beef production and beef requirements to be made with confidence. Some of the key factors that affect the industry's future include:

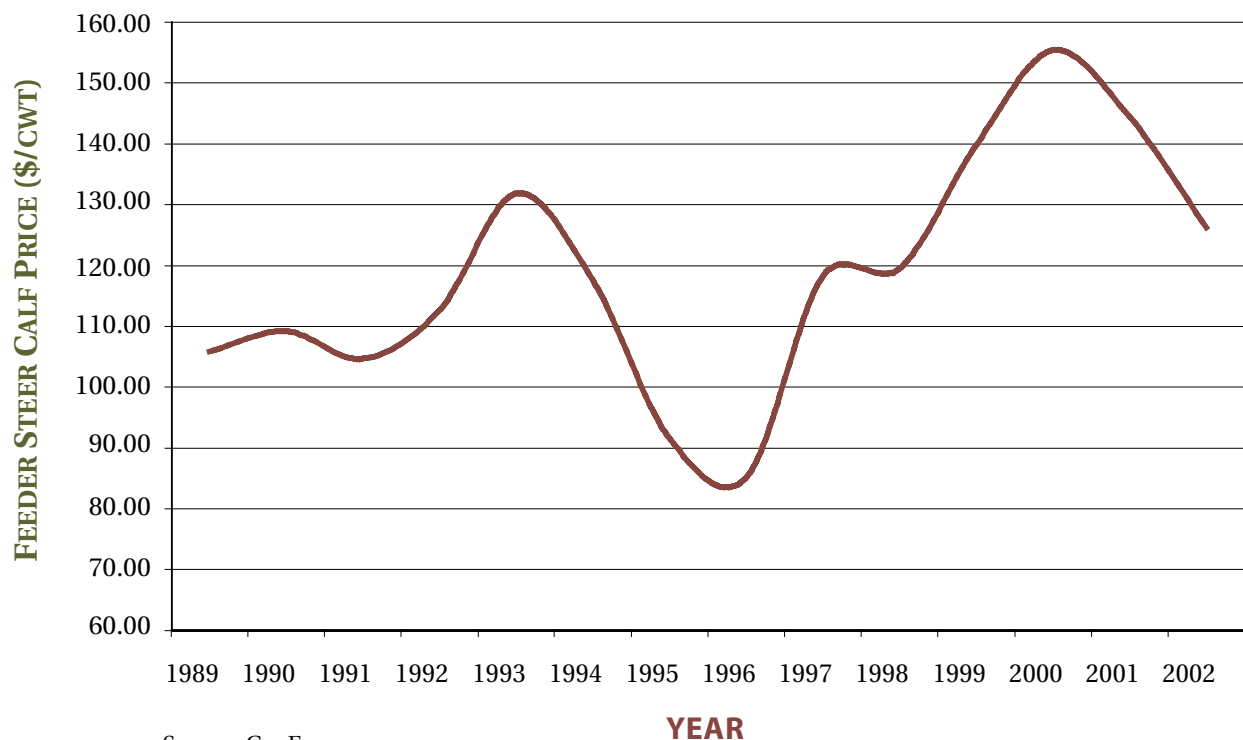
- primary producers continuing to reduce unit costs of production
- the response of the North American beef industry to consumer preferences and a need for the creation and marketing of new products to meet specific requirements
- public sector investment in production and business management research, technology development and extension to stay competitive with other global competitors
- the long-term profitability of the cereals and oilseeds sectors as competitive users of agricultural land

- the resolution of trade and regulatory issues, both domestically and internationally, to clear the path for sustainable and profitable industry growth
- the beef industry's ability to convey the message to consumers and the general public that Alberta producers and processors are responsible stewards of the land and livestock, treat livestock humanely and are intent on producing healthy and safe food products.

Canada, especially Alberta, will continue to play a significant role in the global beef market for some time. However, gains in this complex business are hard fought.

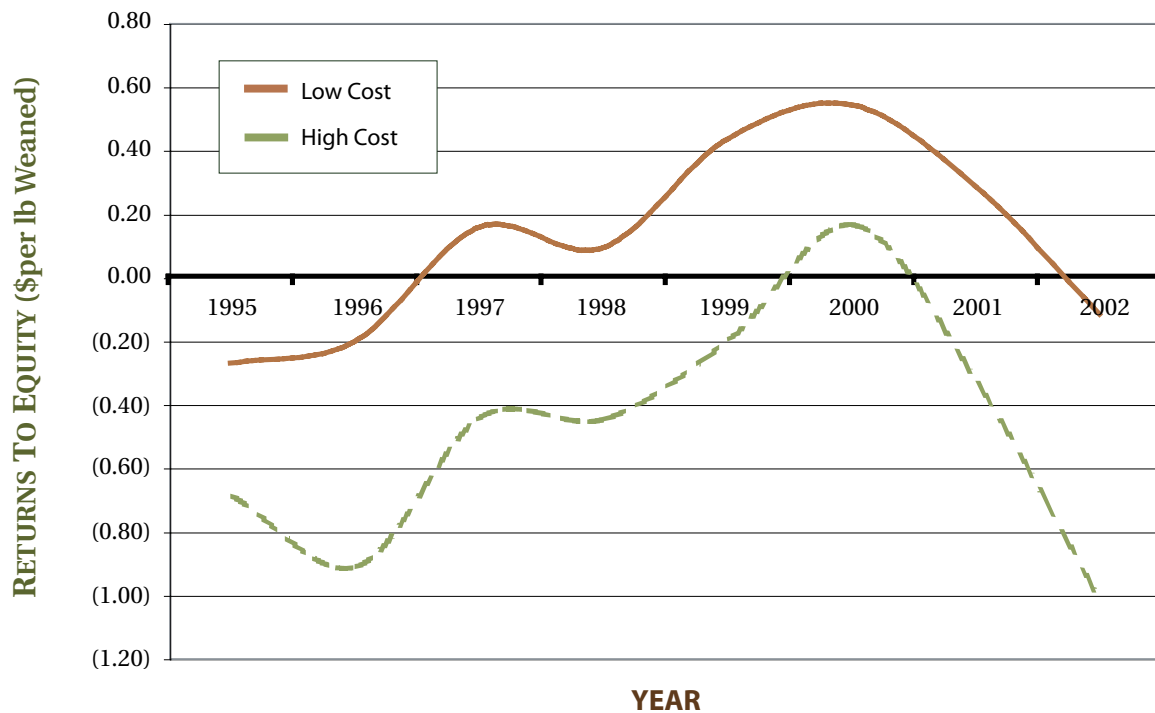
## Cow-calf Production Economics

Cow-calf enterprises are typically modest margin and low rate-of-return businesses. By actively managing both production and economic performance, these enterprises can turn a long-term profit. Typically, the first place business managers look when examining profit potential is in the price received for the product (Figure 6). However, from a longer-term, strategic point of view, and because of the nature of cow-calf enterprises, a focus on price as the main driver of profit can be misleading and actually result in poorer net returns. Economic research shows that producers who focus on maintaining low costs per pound (or kilogram) of calf weaned, are more consistently and reliably profitable (Figure 7).



Source: CanFax

**FIGURE 6.** Central Alberta feeder steer calf price, fourth quarter



**FIGURE 7.** Profitability of low-cost vs. high-cost cow-calf enterprises

Keeping costs low does not imply minimizing expenditures. Operating a cow-calf enterprise involves managing a fine balance between revenues and expenses. Higher productivity (pounds of calf weaned per cow) generally translates into higher total revenues. However, on the cost side, at some point the dollars invested to achieve the added production outstrip the added revenues. Consequently, using the low cost per pound of calf weaned criterion to monitor and manage economic performance builds in this balance. The level of production inputs and enterprise investment are determined by what they can add to profitability. The common sense interpretation is that added costs are incurred up to the point where they are no longer covered by added revenue. Although this may seem simplistic, active management with this goal as the underlying theme is the path to success in the cow-calf business.

## Key Management Areas

Success in the cow-calf business is measured in small steps. Incremental changes in production practices, input use or investment rarely translate into large changes in profitability. However, methodically managing productivity and costs does accumulate into consistent improvements in the enterprise's bottom line.

This does not mean constant hands-on management of all aspects of the operation. Many elements do not require constant attention. However, it does mean that planning, budgeting, monitoring and control over the business are necessary so the day-to-day management can focus on achieving the targets set in the operating plans.

The three main drivers of profitability in cow-calf enterprises are:

- optimizing (not maximizing) productivity, measured by pounds of calf weaned per cow
- controlling feed costs
- controlling fixed costs, or overheads

Within these elements, some decisions may influence short-term performance, within a one-year production cycle, while others may result in benefits or burdens over many years.

Short-term management that focuses on controlling costs revolves around feed costs (both over the winter and during the grazing season) and the annual cost of getting the feed to the herd. Considerations include:

- providing cost-effective winter rations that maintain the required productivity levels, often focused on management groups within the herd
- managing grazing resources to meet the reproductive and milk production needs of the herd in a cost effective manner
- managing the operating costs (e.g. fuel and labour) associated with getting the feed to the herd

In addition to managing these cost elements, ongoing attention to productivity (pounds weaned per cow) also contributes to reducing costs per pound weaned.

Longer-term business structure factors can significantly affect profitability. Some examples are labour requirements and overhead. Labour is a valuable input to the operation, particularly in terms of maintaining productivity levels. If the herd is moving to a larger average cow size, increased labour is required in terms of feeding and calving management. Changes in labour requirements



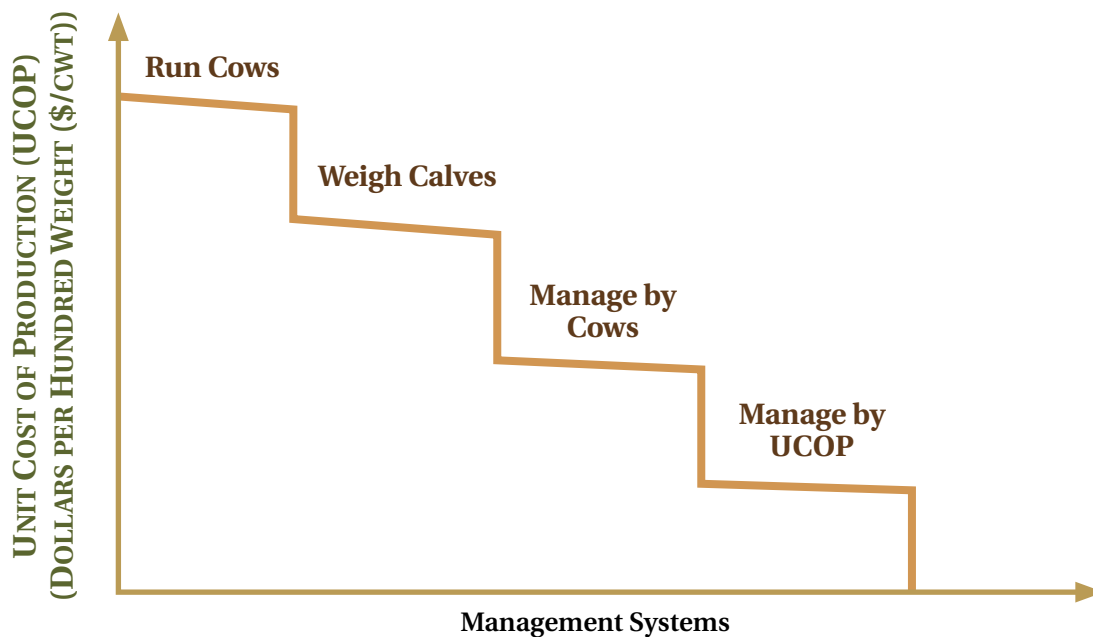
*Summer grazing is one component of your annual feed costs.*

tend to come about slowly and the added costs are not readily apparent. Overhead investment such as feeding and feed handling equipment can be a double-edged sword. Although the equipment may result in efficiencies in delivering feed to the herd, it can also create a long-lasting depreciation cost.

## You Have to Measure it to Manage it

The ability to measure the productive and economic performance of a cow-calf enterprise is critical to long-term profitability. Astute cow-calf producers maintain a reasonable set of production and accounting records as a basis for developing management information. With the resulting productivity, economic and financial management information in hand, producers can actively lay out their route to profitability. They control their business rather than having their business control them. Figure 8 shows that the more production and economic information producers gather on their operation, the more useful it is. The more intense your knowledge and management of your herd becomes, the lower your unit cost of production (UCOP) per pound of calf weaned will be. Again, the target is to use information to manage unit production costs per pound of calf weaned.





Source: Dr. Harlan Hughes, Extension Economist, NDSU (retired)

**FIGURE 8.** Management systems and associated cost of production plateaus

## Budgeting and Benchmarking

Enterprise analysis, including both physical and economic performance information, performs a few major roles for cow-calf producers. It can be used as:

- a basis for setting annual enterprise budgets and targets for upcoming production seasons
- a source of costing and productivity information to do partial budgeting and the assessment of operational changes
- a means to monitor year-to-year progress

Cow-calf enterprise overview worksheets, drawn from Alberta Agriculture and Food's AgriProfit\$ production economics research program, are provided in Tables 1, 2 and 3. Budgets are provided for Southern Alberta (Mixed Grassland, Moist Mixed Grassland and Fescue Grassland regions), Central Alberta (Aspen Parkland region) and Northern Alberta (Boreal Transition and Peace Lowland regions).

The low-cost group values are the average values between 2000 and 2002 for producers in the region who had low total production costs per pound (lb.) weaned. Space is provided on the worksheets for you to insert your own estimates.

The low-cost group budgets can be used as:

- a guideline to develop your own analysis;
- a basis of comparison (benchmarking) to judge the performance of your own operation; and/or
- a proxy for cost elements if you do not have enough experience with on-farm records to make your own cost estimates.

Remember that unit costs vary considerably from farm to farm due to differences in production practices, cost structures, etc. More information about the economics of cow-calf enterprises can be found on Alberta Agriculture and Food's website at: [http://www1.agric.gov.ab.ca/\\$department/deptdocs.nsf/all/econ8479](http://www1.agric.gov.ab.ca/$department/deptdocs.nsf/all/econ8479)



TABLE 1. Cost of production comparison worksheet - Southern Alberta  
Cow-calf Enterprise Overview – Economic Performance Comparisons

(A)	Low Cost Group		Your Estimate	
	\$/Cow	\$/lb Weaned	\$/Cow	\$/lb Weaned
1. Weaned Calves	682.37	1.350		
2. Feeder Calves	0.00	0.000		
3. Slaughter Calves	0.00	0.000		
4. Purebred Calves	0.00	0.000		
5. Baby Calves	0.00	0.000		
6. Cull Cows/Open Heifers	123.98	0.245		
7. Bulls	17.53	0.035		
8. Bred Cows/Bred Heifers	22.00	0.044		
9. Miscellaneous Receipts	0.39	0.001		
10. Government Programs	0.00	0.000		
11. Inventory Adjustment	89.43	0.177		
12. Less: Cattle Purchases	264.55	0.523		
<b>Value of Production</b>	<b>671.15</b>	<b>1.327</b>		
<b>(B)</b>				
1. Winter Feed	132.85	0.263		
2. Bedding	2.21	0.004		
3. Pasture	220.53	0.436		
4. Veterinary & Medicine	13.94	0.028		
5. Breeding Fees/Bull Rental	0.23	0.000		
6. Trucking & Marketing Charges	18.04	0.036		
7. Fuel	11.37	0.022		
8. Repairs – Machine	5.49	0.011		
9. Repairs – Corrals & Buildings	8.95	0.018		
10. Utilities & Miscellaneous Expenses	18.74	0.037		
11. Custom Work & Specialized Labour	36.26	0.072		
12. Operating Interest Paid	0.24	0.000		
13. Paid Labour & Benefits	13.46	0.027		
14. Unpaid Labour	40.51	0.080		
<b>Variable Costs</b>	<b>522.81</b>	<b>1.034</b>		
<b>(C)</b>				
1. Share/Lease Cattle Payments	3.45	0.007		
2. Taxes, Water Rates, Lic. & Insurance	9.15	0.018		
3. Equipment & Building	25.40	0.050		
a) Depreciation				
b) Lease Payments	3.57	0.007		
4. Paid Capital Interest	4.13	0.008		
<b>Total Capital Costs</b>	<b>45.70</b>	<b>0.090</b>		
<b>(D) Cash Costs</b>	<b>(B+C-B14-C3)</b>	<b>502.61</b>	<b>0.994</b>	
<b>(E) Total Production Costs</b>	<b>(B+C)</b>	<b>568.51</b>	<b>1.124</b>	
<b>(F) Gross Margin</b>	<b>(A-D)</b>	<b>168.55</b>	<b>0.333</b>	
<b>Return to Unpaid Labour</b>	<b>(A-D+B14)</b>	<b>143.15</b>	<b>0.283</b>	
<b>Return to Investment</b>	<b>(A-E+C4)</b>	<b>106.77</b>	<b>0.211</b>	
<b>Return to Equity</b>	<b>(A-E)</b>	<b>102.64</b>	<b>0.203</b>	
<b>Total Investment</b>		<b>1,650.17</b>		
<b>Production Performance Comparisons</b>				
Calf Crop (%)		84.5		
% Calved – 1st 2 Cycles		90.0		
lb Calf Weaned/Cow Exposed		453.5		
lb Calf Weaned/Cow Wintered		505.6		
Wean Weight (Wt) as a % of Cow Wt		43.1		
Wt per Day of Age (lbs)		2.61		
Cows Wintered		237		
Labour (hours per cow)		5.2		
Feeding Season (days)		91.4		
Growth (weaning wt)		536.4		
Open Cows (%)		8.2		
Length of Calving Period (days)		78.9		
Death Loss of Calves (%)		3.6		

Source: Alberta Agriculture and Food, Economics & Competitiveness Division, *AgriProfits* Costs and Returns (C.A.R.) Program

TABLE 2. Cost of production comparison worksheet - Central Alberta  
Cow-calf Enterprise Overview – Economic Performance Comparisons

(A)	Low Cost Group		Your Estimate	
	\$/Cow	\$/lb Weaned	\$/Cow	\$/lb Weaned
1. Weaned Calves	736.39	1.316		
2. Feeder Calves	0.00	0.000		
3. Slaughter Calves	0.00	0.000		
4. Purebred Calves	0.00	0.000		
5. Baby Calves	0.12	0.000		
6. Cull Cows/Open Heifers	120.24	0.215		
7. Bulls	15.15	0.027		
8. Bred Cows/Bred Heifers	24.49	0.044		
9. Miscellaneous Receipts	0.44	0.001		
10. Government Programs	0.00	0.000		
11. Inventory Adjustment	112.65	0.201		
12. Less: Cattle Purchases	286.50	0.512		
<b>Value of Production</b>	<b>722.99</b>	<b>1.292</b>		
<b>(B)</b>				
1. Winter Feed	260.67	0.466		
2. Bedding	20.83	0.037		
3. Pasture	162.81	0.291		
4. Veterinary & Medicine	21.53	0.038		
5. Breeding Fees/Bull Rental	0.90	0.002		
6. Trucking & Marketing Charges	11.91	0.021		
7. Fuel	18.29	0.033		
8. Repairs – Machine	12.03	0.021		
9. Repairs – Corrals & Buildings	4.60	0.008		
10. Utilities & Miscellaneous Expenses	19.09	0.034		
11. Custom Work & Specialized Labour	4.12	0.007		
12. Operating Interest Paid	3.70	0.007		
13. Paid Labour & Benefits	7.58	0.014		
14. Unpaid Labour	54.72	0.098		
<b>Variable Costs</b>	<b>602.79</b>	<b>1.077</b>		
<b>(C)</b>				
1. Share/Lease Cattle Payments	1.90	0.003		
2. Taxes, Water Rates, Lic. & Insurance	6.83	0.012		
3. Equipment & Building	a) Depreciation	37.43	0.067	
	b) Lease Payments	0.00	0.000	
4. Paid Capital Interest	7.00	0.013		
<b>Total Capital Costs</b>	<b>53.16</b>	<b>0.095</b>		
<b>(D) Cash Costs</b>	<b>(B+C-B14-C3)</b>	<b>563.80</b>	<b>1.008</b>	
<b>(E) Total Production Costs</b>	<b>(B+C)</b>	<b>655.94</b>	<b>1.172</b>	
<b>(F) Gross Margin</b>	<b>(A-D)</b>	<b>159.19</b>	<b>0.284</b>	
<b>Return to Unpaid Labour</b>	<b>(A-D+B14)</b>	<b>121.76</b>	<b>0.218</b>	
<b>Return to Investment</b>	<b>(A-E+C4)</b>	<b>74.04</b>	<b>0.132</b>	
<b>Return to Equity</b>	<b>(A-E)</b>	<b>67.04</b>	<b>0.120</b>	
<b>Total Investment</b>		<b>1,939.25</b>		
<b>Production Performance Comparisons</b>				
Calf Crop (%)	89.0			
% Calved – 1st 2 Cycles	84.7			
lb Weaned/Cow Exposed	520.2			
lb Weaned/Cow Wintered	559.6			
Wean Weight (Wt) as a % of Cow Wt	46.0			
Wt per Day of Age (lbs)	2.72			
Cows Wintered	194			
Labour (hours per cow)	6.4			
Feeding Season (days)	187.7			
Growth (weaning wt)	584.2			
Open Cows (%)	7.2			
Length of Calving Period (days)	101.5			
Death Loss of Calves (%)	2.6			

Source: Alberta Agriculture and Food, Economics & Competitiveness Division, *AgriProfits* Costs and Returns (C.A.R.) Program

TABLE 3. Cost of production comparison worksheet - Northern Alberta  
Cow-calf Enterprise Overview – Economic Performance Comparisons

(A)	Low Cost Group		Your Estimate	
	\$/Cow	\$/lb Weaned	\$/Cow	\$/lb Weaned
1. Weaned Calves	703.18	1.307		
2. Feeder Calves	0.00	0.000		
3. Slaughter Calves	0.00	0.000		
4. Purebred Calves	0.00	0.000		
5. Baby Calves	0.47	0.000		
6. Cull Cows/Open Heifers	109.66	0.204		
7. Bulls	17.39	0.032		
8. Bred Cows/Bred Heifers	72.55	0.135		
9. Miscellaneous Receipts	1.44	0.003		
10. Government Programs	0.00	0.000		
11. Inventory Adjustment	29.40	0.055		
12. Less: Cattle Purchases	261.12	0.485		
<b>Value of Production</b>	<b>672.97</b>	<b>1.251</b>		
<b>(B)</b>				
1. Winter Feed	227.71	0.423		
2. Bedding	13.32	0.025		
3. Pasture	144.92	0.269		
4. Veterinary & Medicine	18.14	0.034		
5. Breeding Fees/Bull Rental	2.11	0.004		
6. Trucking & Marketing Charges	11.69	0.022		
7. Fuel	11.25	0.021		
8. Repairs – Machine	11.88	0.022		
9. Repairs – Corrals & Buildings	5.36	0.010		
10. Utilities & Miscellaneous Expenses	14.33	0.027		
11. Custom Work & Specialized Labour	6.62	0.012		
12. Operating Interest Paid	5.46	0.010		
13. Paid Labour & Benefits	13.76	0.026		
14. Unpaid Labour	50.73	0.094		
<b>Variable Costs</b>	<b>537.29</b>	<b>0.999</b>		
<b>(C)</b>				
1. Share/Lease Cattle Payments	1.30	0.002		
2. Taxes, Water Rates, Lic. & Insurance	5.66	0.011		
3. Equipment & Building	23.27	0.043		
a) Depreciation				
b) Lease Payments	1.21	0.002		
4. Paid Capital Interest	13.49	0.025		
<b>Total Capital Costs</b>	<b>44.93</b>	<b>0.084</b>		
<b>(D) Cash Costs</b>	<b>(B+C-B14-C3)</b>	<b>508.22</b>	<b>0.945</b>	
<b>(E) Total Production Costs</b>	<b>(B+C)</b>	<b>582.22</b>	<b>1.082</b>	
<b>(F) Gross Margin</b>	<b>(A-D)</b>	<b>164.75</b>	<b>0.306</b>	
<b>Return to Unpaid Labour</b>	<b>(A-D+B14)</b>	<b>141.48</b>	<b>0.263</b>	
<b>Return to Investment</b>	<b>(A-E+C4)</b>	<b>104.24</b>	<b>0.194</b>	
<b>Return to Equity</b>	<b>(A-E)</b>	<b>90.75</b>	<b>0.169</b>	
<b>Total Investment</b>	<b>1,650.90</b>			
<b>Production Performance Comparisons</b>				
Calf Crop (%)	88.8			
% Calved – 1st 2 Cycles	85.8			
lb Weaned/Cow Exposed	506.9			
lb Weaned/Cow Wintered	538.0			
Wean Weight (Wt) as a % of Cow Wt	45.9			
Wt per Day of Age (lbs)	2.71			
Cows Wintered	245			
Labour (hours per cow)	6.4			
Feeding Season (days)	189.8			
Growth (weaning wt)	570.9			
Open Cows (%)	7.4			
Length of Calving Period (days)	108.1			
Death Loss of Calves (%)	3.0			

Source: Alberta Agriculture and Food, Economics & Competitiveness Division, *AgriProfits* Costs and Returns (C.A.R.) Program

# Summary

Alberta is a major player in the North American and Canadian beef industry, and the beef industry is a key part of Alberta's agricultural industry. In 2004, cow-calf and beef finishing enterprises accounted for about one-third of Alberta farm cash receipts. Future expansion of Alberta's cattle industry depends largely on the rate of expansion of breeding herds and feeding capacity, as well as the industry's ability to create beef products that are desired by consumers.

North American beef production is subject to a price-and-supply cycle, which typically consists of a united even-year expansion phase, followed by a three-year contraction phase. The time lag between the profit opportunity (higher prices) and the production response (herd expansion) causes and perpetuates the cattle cycle. Predicting how high or low prices will go and when the cycle will turn cannot be done with any degree of certainty. The challenge for producers is to anticipate the price cycles and adjust their production accordingly.

Alberta is in the beef export business. The significance of export markets, both the United States and other international markets, to the Canadian beef industry has been driven home by the BSE situation.

Cow-calf enterprises are typically modest margin and low rate-of-return businesses. By actively managing both production and economic performance, these enterprises can turn a long-term profit. A focus on price as the main driver of profit can be misleading and actually result in poorer net returns. Producers who focus on maintaining low costs per weight of calf weaned are more consistently and reliably profitable. The three main drivers of profitability in cow-calf enterprises are: optimizing productivity (measured by pounds of calf weaned per cow), controlling feed costs and controlling fixed costs.

The ability to measure the productive and economic performance of a cow-calf enterprise is critical to long-term profitability. Astute cow-calf producers maintain a reasonable set of production and accounting records as a basis for developing management information. With the resulting productivity, economic and financial management information in hand, producers can actively lay out their route to profitability.


 Herd

# Management

One of the most important aspects of a beef herd operation is management of reproduction. The importance of reproduction is sometimes minimized and only receives a passing thought when the herd sire is turned out with the breeding herd and is expected to get all cows in calf. This chapter discusses management practices to promote good reproductive performance of the cows, heifers and bulls in your herd.

## Brood Cow

### Management

Although a cow may produce a heavy calf at weaning time, she is a failure if she does not rebreed. Producing a healthy, live calf from each cow in the herd every 12 months is impossible to achieve without appropriate reproductive management. Inadequate nutrition and poor reproductive management of the breeding herd can result in a reduced calf crop.

### Reproductive Efficiency

Reproductive efficiency can be evaluated in several ways:

**Per cent calf crop** is a commonly used measure of efficiency. It is calculated by dividing the total number of calves weaned by the number of cows exposed to breeding. An accepted benchmark (level to aim for) in Alberta is 85 per cent. A reproductive efficiency below that has the potential for improvement.





*Body condition scoring is a yardstick for performance.*

**Weight of calf weaned per 50 kg (100 lb.) of cow exposed** provides a much better measurement of efficiency. An acceptable benchmark is about 20 kg (43 lb.) of calf weaned per 50 kg (100 lb.) of cow exposed. While a herd can be very productive in terms of individual weaning weights, overall herd productivity may be very low when the percentage of calves weaned per cow exposed or weaning weight as a per cent of cow weight is considered. For example, if the average weaning weight of a herd is 250 kg (550 lb.), but the calf crop is only 80 per cent, the average weaning weight per cow exposed would only be 199 kg (440 lb.) (Table 4).

In herds where artificial insemination is practised, **services per conception** are a good measure of an individual cow's fertility.

On a herd basis, **conception rate**, expressed as the number of cows that become pregnant as a percentage of those exposed, is a good measure of reproductive efficiency.

## Body Condition and Reproduction

Body condition is an expression of the amount of body fat that an animal is carrying. It is a useful tool to predict herd fertility and to determine feeding programs.

The relationship between body condition and reproductive performance is strong and deserves consideration when striving for high levels of reproductive performance. There are five points to consider. These include:

- why, how and when to condition score
- the relationship between body condition and post-calving fertility
- the relationship between body condition and calf weaning weight
- feeding strategies in relationship to body condition
- practical application of condition scoring

### Why Body Condition Score?

Body condition scoring is a “hands-on” method of determining the amount of fat an animal is carrying. It is easy to learn, fast, simple and cheap. It does not require specialized equipment, is sufficiently accurate and has many management implications.

Body condition scoring allows everyone to speak the same language when describing body condition. It uses a numerical rating system based on the feel of a cow, rather than ambiguous descriptions based simply on a visual appraisal.

TABLE 4. Effect of per cent calf crop on average weight of calf weaned per cow exposed

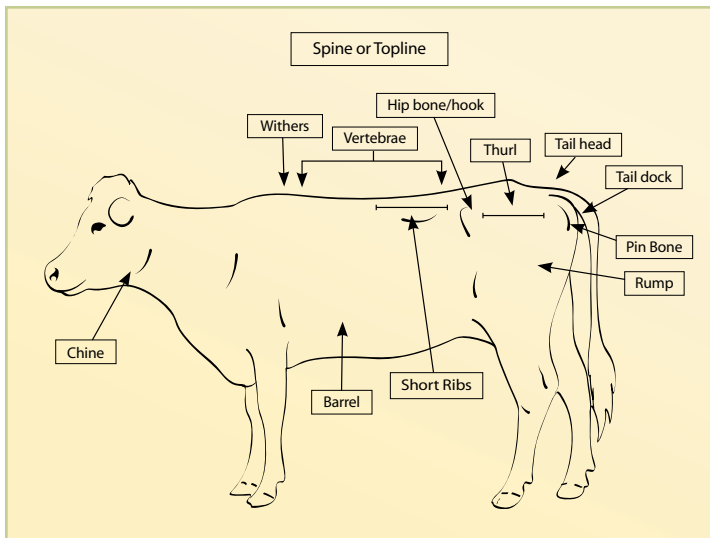
Calf crop (%)	Average weight of calf weaned per cow exposed				
	kg (lb.)	kg (lb.)	kg (lb.)	kg (lb.)	kg (lb.)
100	181 (400)	204 (450)	227 (500)	250 (550)	272 (600)
90	163 (360)	183 (405)	204 (450)	225 (495)	245 (540)
80	145 (320)	163 (360)	181 (400)	199 (440)	218 (480)
70	127 (280)	143 (315)	159 (350)	175 (385)	190 (420)



## How to Body Condition Score

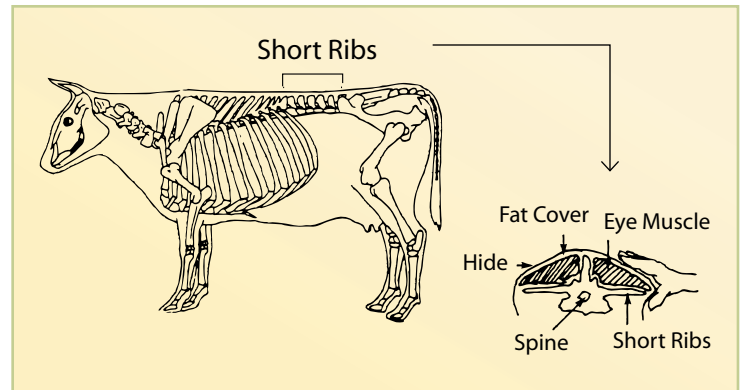
Condition scores are measured by feeling for fat cover with your hands. The scores cannot be measured visually because a full hair coat can hide poor condition. You measure the fat cover over four major locations on the animal's body: back bone (spine or topline), short ribs, hip bones (hooks and pins) and tail head (Figure 9).

Start by doing a general assessment of the animal's entire body. Look closely at those areas of the body where accumulation or loss of fat reserves typically occurs, including the back bone, short ribs, hook and pin bones and tail head. Then run your hands down the back bone to check the condition of the vertebrae. Can you feel the tops of the vertebrae or not?



**FIGURE 9.** Characteristics of a beef cow with a BCS score of 3

Then assess the short ribs for condition (Figure 10). Place your hand on top of the short ribs, with your fingers pointing towards the spinal column. Placing your hand on top of the short ribs anchors your hand, providing your thumb with sufficient strength to push through the hide and the fat layer (if it is present) to feel the bone. Use your thumb and roll it over the end of the short rib. Can you feel the tip of the short rib bone? Is it smooth or sharp? Since there is no muscle between the end of the short ribs and the skin, any padding felt by the thumb is fat.



**FIGURE 10.** Assess the short ribs

Next, run your hands over the hip bones including the hooks and pins, pushing down with pressure, to determine if there is fat cover or not. Then with your fingertips, push down on the tail head to pin area to determine if there is fat present or not in the tail head area.

## CANADIAN CONDITION SCORING SCALE

The Canadian condition scoring system uses the following descriptions to define each score:

**Score 1: Entire body:** The entire body is extremely thin and all skeletal structures are visible. No muscle tissue is evident and no external fat is present. The hair coat appears to be dull. Survival during stress is doubtful.

**Back bone:** The individual vertebrae are well defined and very sharp. You can place fingers between each vertebra.

**Short ribs:** The individual short ribs are visually prominent and very sharp to the touch.

**Tail head and hooks:** The tail head and hooks are visually prominent. There is no fat around the hip bone, pin bone and tail head.



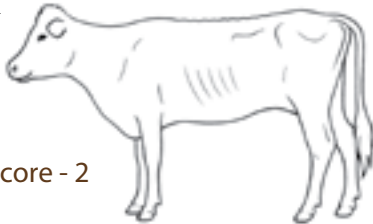
Condition Score - 1

**Score 2: Entire body:** The animal is thin. The vertebrae along the topline are prominent. Muscle tissue is evident, but not abundant.

**Back bone:** The individual vertebrae can be felt, but are not as sharp. Fingers can't be placed between vertebrae.

**Short ribs:** The short ribs can be identified individually when touched, but they feel sharp rather than very sharp. Individual ribs can be identified visually.

**Tail head and hooks:** There is some tissue cover around the tail head and over the hip bone and pin bones. The tissue can be felt with firm pressure, with no fat pad palpable.



Condition Score - 2

**Score 3: Entire body:** A condition score of 2.5 to 3 is the ideal condition for calving. The ribcage is only slightly visible. Muscle tissue is nearing the maximum. There are obvious fat deposits behind the front shoulder. Areas on each side of the tail head are fairly well filled, but not mounted.

**Back bone:** The individual bones are somewhat defined. It is difficult to feel the top of the vertebrae.

**Short ribs:** The ribs are completely covered with fat. Individual ribs can only be felt with firm pressure and feel rounded, but are not noticeable to the eye.

**Tail head and hooks:** The areas on either side of the tail head have a degree of fat cover, which is easily felt. The hooks and pins are visible, but not prominent. Fat cover in the tail head to pin area feels slightly spongy when the fingers are pressed downwards.



Condition Score - 3

**Score 4: Entire body:** The bone structure is no longer noticeable. The skeletal structure is difficult to identify. Folds of fat are beginning to develop over the ribs and thighs of the animal.

**Back bone:** The back bone has a flat appearance to the topline. Individual vertebrae can't be felt unless very firm pressure is used.

**Short ribs:** The individual short ribs cannot be felt even with firm pressure. Folds of fat are beginning to develop over the ribs and thurl area of the animal.

**Tail head and hooks:** Fat cover around the tail head is evident on both sides as slight "rounds" that are soft to the touch.



Condition Score - 4

**Score 5: Entire body:** The animal is obese. The animal has a "blocky" appearance. The bone structure is not noticeable. The animal's mobility is impaired by the large amounts of fat.

**Back bone:** The back bone has a flat appearance and cannot be felt even with pressure.

**Short ribs:** The short ribs are completely covered by fat and can't be felt even with firm pressure. Folds of fat are apparent over the ribs, thurl and thighs.

**Tail head and hooks:** The hip bones and tail head to pin area on both sides are completely buried in fat.



Condition Score - 5

## COMPARING CANADIAN AND AMERICAN SYSTEMS

You could use either the Canadian or the American rating system for body condition scoring. Both are equally accurate. The Canadian system uses a 1 to 5 point scale, whereas the American system uses a 1 to 9 point scale. Table 5 shows the relationship between the two systems. In the Canadian system, if an animal's condition falls between two values, then halves are used. For example, a 2.5 score indicates that the animal is intermediate between a 2 and a 3 for body condition.

TABLE 5. Comparison of the Canadian and American body condition scoring systems

Body condition score system		General description
Canada	American (United States)	
1	1	Emaciated - extremely emaciated and listless
1.5	2	Very Thin - appears somewhat emaciated
2	3	Thin - can see individual ribs
2.5	4	Moderate - individual ribs not obvious
3	5	Good - can feel fat cover over ribs and tail head
3.5	6	Very Good – pressure required to feel short ribs
4	7	Moderately Fat - topline appears flat, feels spongy over ribs
4.5	8	Fat - very fleshy, cannot feel short ribs
5	9	Very Fat - extremely fleshy and blocky, tail head buried in fat

### When to Condition Score

Ideally, cows should be condition scored at three times during in each production year. Condition scoring should be done at:

- fall pregnancy check or the start of winter feeding program and the optimum score is 3.0
- calving - the optimum score is 2.5 for mature cows and 3.0 for first-calf heifers
- thirty days before the start of the breeding season and the optimum score is 2.5 for all females

There is room for variation from these optimums as long as you are aware of the amount the cattle vary from the optimum and you have a plan in place to adjust your management to accommodate the variances. Generally, if cattle are thinner than these optimums, fertility drops. As cattle grow fatter than the optimums, herd productivity is not increased and you are spending more on feed than necessary.

### Condition Score and Post-calving Fertility

Adequate nutrition before and after calving is essential for optimum reproductive performance. Feeding programs that result in thin cows at calving or in a loss of body condition after calving increase the interval from calving to estrus (standing heat) and decrease first-service conception rates. An increase in days to estrus or a decrease in conception rate results in fewer cows becoming pregnant in the first three weeks of the breeding season.

Table 6 summarizes several research trials and shows that cows with a score of 2.0 or less took longer to return to normal estrus than cows that scored 2.5 or greater. Cows with a score of 2.0 or less at calving had a lower pregnancy rate in the first part of the breeding season, regardless of the feeding program after calving. A high percentage (91 per cent) of cows that calved in very good condition (3.5) showed estrus by 60 days, as compared to 46 per cent of thin condition cows (2.0).

TABLE 6. Effect of body condition score at calving on subsequent reproduction

Body condition	Per cent of cows exhibiting estrus		
	40 days after calving	60 days after calving	80 days after calving
Thin (2.0)	19	46	62
Moderate to good (2.5 - 3)	21	61	88
Very good (3.5)	31	91	98

Sources: Houghton et al. (1990), Randel (1990)

Table 7 shows that feeding increased levels of energy can improve reproductive performance of cows calving in thin condition. In this study the postpartum interval was shortest for cows that received the low level of energy during gestation and the high level of energy after calving. Only 33 per cent of cows fed low energy during both pre- and postpartum were in estrus by 60 days, as compared to 56 per cent of the cows fed low energy prepartum and high energy postpartum.

TABLE 7. Effect of increasing energy (or flushing) on reproductive performance

	Pre- and postpartum energy levels			
	Low-low	Low-high	High-low	High-high
Postpartum interval (days)	73	54	66	68
In estrus by 60 days (%)	33	56	53	54

Source: Houghton et al. (1990)

To obtain optimum post-calving fertility, mature cows should calve in a body condition score of 2.5 to 3.0 and be able to maintain that condition through the breeding season. Flushing, the practice of feeding a very high level of energy for a couple of weeks before the start of the breeding season, only works in cows that are slightly below optimum condition and can gain condition to reach an optimum score of 2.5 to 3.0 during flushing. Flushing does not enhance reproduction in thin cows scoring 1.5 or less, as they are unable to gain enough condition during flushing. Cows that are in a body condition score of 2.0 about 30 days before the start of the breeding season may be helped to rebreed by the use of flushing and the use of a controlled suckling treatment. Controlled suckling involves removing a calf for 48 hours or limiting nursing to once daily until the cow is in heat.

## Condition Score and Calf Weight

Another adverse effect of inadequate cow nutrition is the reduction in pounds of calf weaned. Reports indicate a five to 25 per cent reduction in the adjusted 205-day weaning weight of calves from dams with a body condition of less than 2.0 at calving and from suckled cows losing condition after calving. The extent of poorer performance in the current year depends on the breed type, the severity of underfeeding before cows go to good pasture and the quality of pasture throughout the grazing season. If the cow herd has access to good pasture within 45 to 60 days of when most calves are born, the weaned weight of the current calf crop may not be reduced as much as indicated above.

The major loss in pounds of calf weaned occurs in the following year. Pounds of calf weaned are lower the following year among undernourished cows because they had rebred later in the previous

year. Weaning weight is markedly affected by the age of the calf at weaning. If one assumes that an average calf will gain about 1 kg (2 lb.) per day from birth to weaning, then for every estrous cycle that a cow remains open, the calf is 21 days younger and about 19 kg (42 lb.) lighter at weaning. The information in Table 8 shows the next year's estimated relative losses, in terms of weight of calf weaned based on various management decisions made before and after calving in the current year.

TABLE 8. Effect of body condition on the current year's feed cost and next year's calf weaning weight

Pre-calving management	Winter feed cost <sup>a</sup> (% of maintenance)	Cow condition at calving	After-calving management	Weeks delay in conception (80-day exposure)	Loss in next year's calf weaning weight
Lose condition from 2.5 to 2.0	85 - 90	2.0	Lose condition from 2.0 to 1.5 or less	10	Up to 70% loss
Maintain condition at 2.0	100	2.0	Maintain condition at 2.0	8	Up to 40% loss
Gain condition from 1.5 to 2.0	120 - 130	2.0	Gain condition from 2.0 to 2.5	5	Up to 15% loss
Lose condition from 3.0 to 2.5	85	2.5	Lose condition from 2.5 to 2.0	2	5% loss
Maintain condition at 3.0	100	3.0	Maintain condition at 3.0	0 <sup>b</sup>	0% loss
Gain condition from 2.5 to 3.0	120 - 130	2.5	Gain condition from 2.5 to 3.0	0 <sup>b</sup>	0% loss

**a** Winter feed cost relative to maintenance can only be calculated if the amount of condition gained or lost is known. Losing 0.23 kg/head/day (0.5 lb./head/day) of body tissue would result in a loss of 0.5 units of condition score in 200 days and would reduce feed cost by 10 to 15%. Gaining 0.5 unit of condition requires twice as much energy as losing 0.5 unit of condition score.

**b** Conceived in the first 21 days of breeding.

Note: This table doesn't include weight change caused by fetal growth.

## Condition Score and Feeding Strategies

The ideal feeding program is one that recognizes the ability of the beef cow to safely and economically gain and lose body condition, if the change in condition is gradual. It costs over twice as much to improve body condition as it does to use excess body condition to supplement the daily energy intake. Therefore, producers should improve body condition when dietary energy is least expensive (usually in the summer) and let the cow lose condition when dietary energy is expensive (usually in the winter). Remember that a rapid loss in condition is not safe and a rapid increase in condition is not always possible.

If a cow is fed to lose one-half of a body condition score over the winter, there will be a savings in winter feed costs. In contrast, feed costs will be 20 to 30 per cent higher for cows fed to gain one-half of a body condition score over the winter, as compared with those fed to maintain body

condition. As noted above, mature cows should calve in a body condition score of 2.5 to 3.0 and be able to maintain that condition through the breeding season.

Also remember that, while condition scoring is a useful tool for evaluating the present energy status of a cow, it is not useful in determining if she has received an adequate amount of the other important nutrients such as protein, vitamins and minerals. For information on nutrition management, see the Nutrition and Feeding Management chapter.

## Using Body Condition to Manage Feeding Costs

Fat represents the storage of energy in a body. Cows can accumulate body fat during periods of surplus energy, building up a reserve of energy that can be drawn upon in times of need. The term "feeding off her back" refers to the use of previously accumulated body fat.



The accumulation of fat in beef cattle is not an efficient process. The efficiency of retaining digestible energy (DE) in the form of body tissue varies from about 30 per cent for dry cows fed low quality diets to about 60 per cent for suckled cows fed high quality diets. To improve one unit of body condition score requires about 1,900 megacalories (Mcal) of DE. This is the equivalent of over 544 kg (1,200 lb.) of barley grain or almost 900 kg (2,000 lb.) of hay. Each unit loss of body condition score will supply the equivalent of 900 Mcal of DE. This is equal to 272 kg (600 lb.) of barley or 408 kg (900 lb.) of hay. This demonstrates how metabolically expensive it is to use back fat as an energy source, rather than feeding adequate amounts when necessary.

How can body condition be manipulated to reduce feeding costs? It is a common practice to put lactating cows on good quality feed, usually pasture, for six to eight months after calving. In addition to stimulating milk production, considerable weight gain is usually achieved, especially in late lactation. Many mature cows gain in excess of 90 kg (200 lb.) (the equivalent of one unit of body condition score) during the pasture season. A reasonable target for body condition at fall weaning is 3.0. If this condition is not achieved by the end of the summer grazing season, producers should consider weaning calves earlier so that the cows have at least one month of good fall grazing in which to gain condition before winter feeding begins.

Cows entering the winter with a condition score of 3.0 have several advantages over cows scoring less than 2.0. The extra fat tissue provides some internal insulation against heat loss. It also provides an energy reserve that can be called upon when the amount of daily feed is limited to meet the cow's

needs in order to reduce wintering costs. A 590-kg (1,300-lb.) cow scoring 2.5 needs enough energy and protein to maintain her body weight and condition over the winter and provide for the nutrition of the growing fetus. She requires about 12 kg (27 lb.) of hay per day to do this. However, a 635-kg (1,400-lb.) cow scoring 3.0 can afford to contribute about one-half pound of body tissue "off her back" each day. This reduces the amount of feed required. She needs about 11 kg (24 lb.) of hay per day, a savings of 12 per cent. The feed waste factor, present in all feeding systems, increases the amount of hay that must be offered to reach these levels of intake.

Sometimes, cows enter the winter in thin condition (score less than 2.0) and need to gain considerable weight before calving. A cow that has to improve one unit in condition [gain approximately 90 kg (200 lb.)] must be fed approximately 50 per cent more to achieve the weight gain.

Cows that calve with a condition of less than 2.5 need to gain weight rapidly. If an improvement of one-half unit of condition score, a weight increase of 38 kg (100 lb.), is required in the first 60 days after calving, a high quality ration must be fed. Approximately 5 kg (12 lb.) of barley per day is required above what the cow needs for normal maintenance and milk production. Under most conditions it is very expensive to feed cows that score less than 2.0 well enough between calving and breeding to have a positive effect on fertility.

## Using Body Condition for Grouping Cattle by Feeding Needs

Condition scoring can be used to sort a herd into groups that have similar nutritional needs. Both bred heifers and thin cows need more energy than mature cows that score 2.5 to 3.0. They also benefit from reduced competition for feed, if they are fed separately.

## Practical Application of Condition Scoring

### Learn How to Condition Score

Producers do not need to remember the criteria for all five condition scores. The most useful score to remember is 3.0 (good body condition). Keep records of individual condition scores to determine specific causes of individual infertility. Cows

*Cows should start the winter with a condition score of 3.0 or better.*





should be scored in the fall, at calving and 30 days before the start of the breeding season. If condition scoring the cow herd two times after calving is not feasible, consider the alternative of twice per year; once in the fall and once after calving, possibly at vaccination times. Although condition scoring the cows between calving and the start of the breeding season may be inconvenient, breeding problems caused by inadequate nutrition are most likely to be detected during this critical time. A representative group of cows from large herds can be scored to give an indication of the average herd condition score.

## Use Condition Scores as Management Indicators

### *Thin cows (scoring 2.0 or less)*

- Possible reasons:
  - lack of sufficient feed
  - excessive competition at the feed bunk
  - internal/external parasites
  - disease or injury
- Be aware of problems that may be encountered:
  - increased calving difficulty (scores of 1 or less)
  - increased calf death loss
  - delayed breeding or open cows
  - fewer pounds of calf weaned
- Make corrective management decisions:
  - feed young and thin cows separately from mature cows that are in adequate condition
  - improve winter diet, rather than short-term “flushing,” of thin cows to increase reproductive rates
  - control parasites
  - vaccinate against common diseases
  - wean calves about one month earlier in the fall

### *Fat cows (scoring 3.5 or greater)*

- Possible reasons:
  - did not wean a calf
  - produced very little milk
  - were overfed

- Be aware of problems that may be encountered:
  - increased calving difficulties (scores of 4.0 or greater)
  - decreased calf vigour and survival
  - lower fertility
  - low weaning weights
  - feed costs too high
- Make corrective management decisions:
  - cull infertile cows and cows that produce small calves
  - do not overfeed cows already in adequate body condition (score of 2.5); feed separately if necessary
  - let cows coming off pasture with a body condition score of 3.0 or better lose some condition over the winter

## Reproductive Management of the Beef Cow

The following factors are closely related to good reproductive efficiency in the beef herd and should be considered for obtaining or maintaining a highly productive beef herd.

### Breeding Management

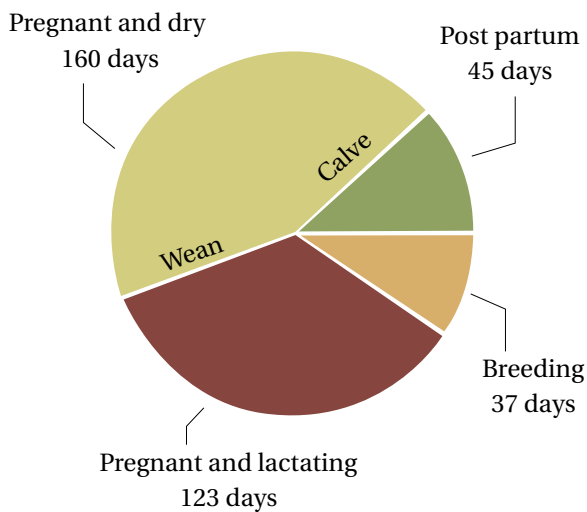
Successful beef cattle production depends on proper management of the biological cycle to attain stable production. The biological cycle of the beef cow is constant and well-defined. This cycle can be divided into four definite periods and one variable period (Table 9).

TABLE 9. Biological cycle of a beef cow

Biological period	Duration in days
First trimester of gestation	94
Second trimester of gestation	94
Third trimester of gestation	94
Postpartum period (rebreeding)	83
Pre-weaning period	variable
Total days	365

The gestation length or pregnancy in beef cows can range from 270 to 300 days. The average range is 282 to 285 days. First-calf heifers tend to have shorter gestations than mature cows. The exotic breeds (such as Simmental, Limousin and Salers) tend to have slightly longer gestation periods than the British breeds (such as Hereford, Shorthorn and Angus).

The chronological cycle varies according to the length of the postpartum period and the date the cow is bred (Figure 11). When the cow is bred, the next gestation period begins (first trimester). However, the cow's chronological cycle continues as she must raise a calve, which will be weaned at about 205 days (range of 180 to 240 days) after calving. The beef cow has a difficult task in weaning a calf each year and calving early again the next season.



**FIGURE 11.** Cow biological-chronological calendar

The biological cycle and the chronological cycle are important to the producer. If a cow is to conceive and calve every 365 days, she must do so within the time frame of the biological cycle. Management strategies should complement the various periods within the biological cycle. However, remember that management determines the chronological cycle by selecting the calving season and thus the breeding date. Since not all cows are bred the same day, the chronological cycle varies for cows within the same herd. The shorter the breeding season, the more efficient management strategies will be for all cows. Since beef cows mother calves until weaning, the biological cycle overlaps the chronological cycle.

## Rebreeding Management

Since the cow is pregnant about 282 to 285 days of the year, there are only 80 days for the cow to be rebred if she is to maintain a yearly calving interval. This is a short period of time, considering the cow must recover from the stress of calving and feed her calf while her reproductive tract is returning to its normal size and position (involution) in preparation for establishment of the next pregnancy.

### MINIMIZE THE POSTPARTUM INTERVAL

The period from calving until the cow conceives is critical in a cow's production cycle. Minimizing this time period is critical for maximizing the reproductive and economic efficiency of the beef cattle operation. Cows that cycle early in the breeding season have more opportunities to become pregnant during a limited breeding season. The length of breeding season influences uniformity of calves and their value at weaning. By keeping other factors constant, such as genetics, age of dam and nutrition, cows conceiving early in the breeding season generally have older calves that have heavier weaning weights.

The ability to minimize the postpartum interval is limited by uterine involution. The time for complete uterine involution is between 30 and 45 days after calving and generally it takes 45 to 60 days before a cow shows her first estrus. Usually, uterine involution occurs within 20 days postpartum and does not usually limit cycling. However, the interval from calving to first estrus can vary widely as it is affected by the age of the cow, the level of nutrition, calving difficulties and disease (e.g. uterine infection).

Table 10 shows the effect that age and time have on the return of cows to heat following calving. Only 15 per cent of the two- and three-year-olds and 55 per cent of the older cows exhibited estrus 40 days following calving. This difference related to age was maintained until 80 days post-calving when the younger cows began to catch up. The slower return of younger females to full fertility helps explain why second-calf heifers have a lowered percentage of calf crop or have calves born later in the calving season.

TABLE 10. Per cent cows in heat at varying intervals following calving

Age of cow	Days after calving						
	40	50	60	70	80	90	100
5 years or older (% in heat)	55	70	80	90	90	95	100
2 – 3 years (% in heat)	15	30	40	65	80	80	90

Source: Wiltbank et al. (1967)

Several factors contribute to the delay in first-calf heifers exhibiting estrus after calving. Young cows have an extra drain on their system because they are still growing while nursing a calf and often they cannot compete for supplemental feed when running with older cows. By breeding virgin heifers 20 to 30 days prior to the main breeding herd, first-calf cows will have extra time to cycle and conceive during the early part of the next breeding season.

First-calf heifers with high milk production often require supplemental feed to receive adequate nutrition before the breeding season. Without this flushing, researchers have found that high milking heifers fail to conceive and produce a calf in their second calving season. The delay in cows and first-calf heifers showing estrus is also accompanied by a low level of fertility as shown by the conception rates in Table 11.

TABLE 11. Conception rate of cows at first service after calving

Days postpartum	Per cent first-service conception
0 - 30	33
31 - 60	58
61 - 90	69
91 - 120	74

Research has also indicated that conception rates before 60 days and after 120 days after calving are low. Many of the cows that fail to conceive within 120 days are problem breeders and are often open at the end of the breeding season. (See the section on *Evaluating Individual and Herd Performance* for information on how to use such cow performance information in herd management.)

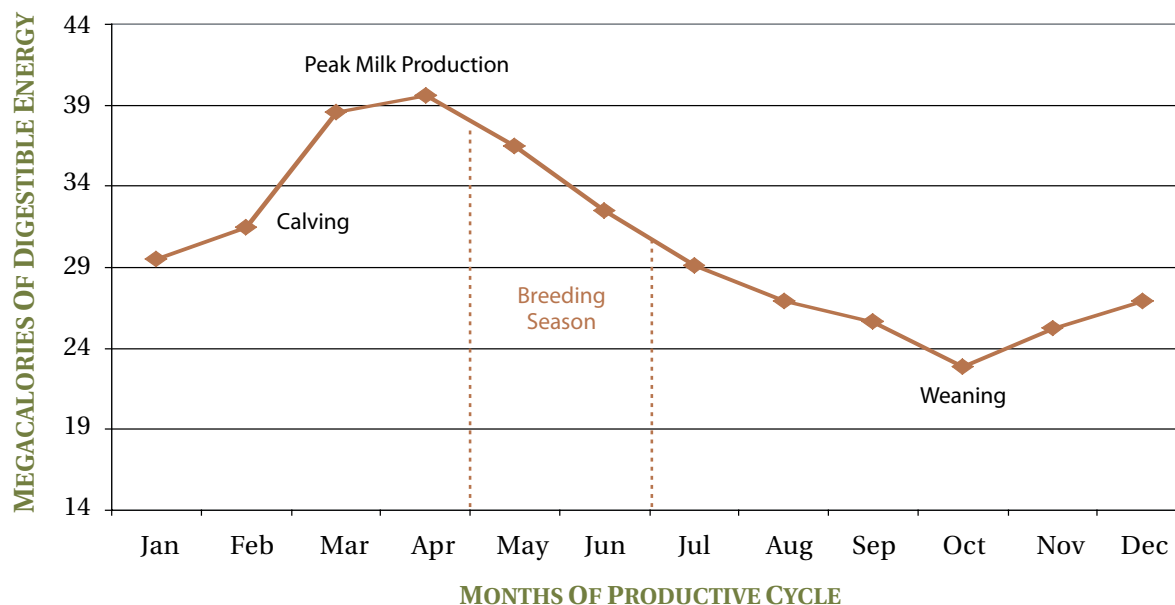
## Strategies to Improve Reproductive Efficiency

The following factors are closely related to good reproductive efficiency in the beef herd and should be considered for obtaining or maintaining a highly productive herd.

### ENSURE ADEQUATE NUTRITION

As illustrated in Figure 12, the cow's nutritional needs vary depending on her production level, her phase of production and the environment (e.g. cold winter weather). The cow's energy and protein requirements are lowest when she is dry, which coincides with the mid-third of pregnancy. This period should parallel the time when feed resources are least available, which from an economic standpoint is the time when the lower cost rations could be fed. This period is also the best time to replace weight on thin cows, since nutrients are not being diverted into growth or lactation.

Nutrient requirements increase during pregnancy, especially during the last trimester of pregnancy, due to the growth of the fetus. The fetus, fetal membranes and fetal fluids attain only 25 per cent of their final weight during the first six months of gestation. The final 75 per cent is gained during the last third of gestation, placing a detectable nutrient demand on the dam. Therefore, energy and protein for females three months before calving should be increased as their requirements start to increase during this period (Figure 12). The nutrient requirements peak during the early lactation period, due to the increased nutritional needs for milk production and reproduction. The energy requirement increases by about 60 per cent and the protein requirement doubles during the early part of the milking and breeding season in comparison to the dry period. Maximum milk production without supplying adequate feed can mean a reduced conception rate.



**FIGURE 12.** Energy requirement for a 590-kg (1,300-lb.) beef cow by stage of production

Note: Energy requirements predicted by CowBytes® (1999) version 4

Further evidence of the importance of good nutrition, as demonstrated by the condition of cows at calving, is presented in Table 12. At 80 days after calving 98 per cent of the cows in good condition exhibited estrus, while only 88 per cent of the moderate cows and only 62 per cent of the thin cows exhibited estrus. Most of the cows in thin condition would be unable to maintain the 12-month calving interval that is necessary for a profitable beef operation.

**TABLE 12.** Effect of body condition on percentage of cows showing heat at various periods after calving

Body condition at calving	Number of cows	Per cent of cows exhibiting estrus postpartum		
		40 days	60 days	80 days
Thin	272	19	46	62
Moderate	364	21	61	88
Good	50	31	91	98

Sources: Wiltbank (1978), Randel (1990)

Numerous studies have reported that under-nutrition extends the anestrus period (from calving to the first postpartum estrus). A research review conducted by Randel (1990) shows that inadequate energy or protein diets during pre- and/or post-calving lowered pregnancy rates, reduced first-service conception rates and extended postpartum intervals in suckled postpartum beef females. This paper, published in the American Journal of Animal Science, reviewed research conducted over the last 50 years. It provides evidence that cattle are what they eat; that is, nutrition affects reproduction.

### SHORTEN THE CALVING SEASON

Calves from early calving cows are heavier at weaning. Cows calving late in the calving season wean lighter calves and are likely to have a poor conception rate because of less time for their reproductive system to prepare for rebreeding. As the breeding season is prolonged, individual cows in the herd lose several days each year until eventually one year they do not get rebred. An early return to heat and high first-service conception rates are necessary to achieve and maintain a shortened calving season from year to year.

Once the management of the breeding herd is properly planned and supervised, as many as 70 per cent or more of the cows should conceive in the first heat cycle after the start of the breeding season. With that type of fertility, 97 per cent or more of the cows can be expected to conceive by the end of a 63-day breeding season. Under very high levels of management, some beef herds in Alberta have achieved nearly 100 per cent conception in a 42-day (two heat cycles) breeding season. These herds have a short calving season and wean a more uniform group of calves in the fall.

Another factor to consider in favour of shortening the calving season is labour. However, remember that the demands for labour are intensified during calving season. If the calving season is long and drawn out, conflicts for labour often occur. A short calving season, completed before other spring work begins, can use available labour to its best advantage.

#### **Maintain condition and nutrition of cows:**

The best way to prevent an extended calving season of 90 days or more is to make sure that the cows and replacement heifers are properly prepared for the breeding season. Feeding the cows and first-calf heifers to ensure they have the right condition score at calving helps reduce the number of difficult births and ensures that they start their heat cycles as soon as possible after calving. The nutrition of the breeding herd after calving is very important to maintaining satisfactory first-service conception rates. Cows that are in thin body condition (2.0 or less) often don't rebreed. Overfeeding protein during the breeding season and early gestation, especially if the rumen receives an inadequate supply of energy, may be associated with decreased fertility. (Refer to the *Nutrition and Feeding Management* chapter for more information.)

**Evaluate bulls:** A breeding soundness evaluation should be conducted on all bulls before the start of the breeding season. Bulls should also be observed carefully through the breeding season to ensure they are continuing to service and settle (impregnate) the cows. Attention to bull nutrition and health is also important.

#### **Restricting the breeding season and culling:**

Once high levels of fertility have been established in both cows and bulls through attention to nutrition and health, fertility levels can be maintained by

limiting the breeding season to between 42 and 63 days. Pregnancy testing early is a useful tool for identifying non-pregnant or open cows or heifers. Open cows or heifers should be culled.

Breed first-calf heifers to calve 20 to 30 days ahead of the mature cow herd. The heifers will calve first while the calving crew is fresh and able to give the heifers the needed attention. This also gives the heifers' additional time between calving and breeding, allowing them to cycle and be ready to rebreed on schedule with the mature herd.

**Additional aids:** Other aids can be used to help shorten the breeding season. Calf removal, either temporary or permanent, can increase the number of cows that return to estrus during the breeding season. A common practice in some synchronization programs is 48-hour calf removal. It has been shown to induce cyclicity in cows and first-calf heifers after calving. It is important to provide a clean, dry pen, with grass hay and water. Make sure that pairs "mother-up" when the calf is returned to the mother.

One of the most successful aids in artificial insemination (AI) or synchronization programs has been prostaglandin. When normally cycling cows are injected with prostaglandin, they come into heat in two to three days, permitting breeding by AI or bull. However, prostaglandin and hormones should not be used as a substitute for good management. These drugs are best used under good management with cows that are making weight gains prior to the breeding season and are close to estrus or are showing initial signs of estrus.

## **TRACK COW PERFORMANCE**

### **Evaluating individual and herd performance**

Evaluation of herd performance (based on individual performance) should be done at weaning time, when the production cycle is completed. You can calculate various herd performance indices to determine areas of strength and weakness within the herd, and use this information to address weaknesses and improve overall productivity and profitability.

### **Handwritten vs. computer records**

You can calculate some indices based on your handwritten records. For example, you can measure areas of weakness in your herd.



Using herd management software allows you to calculate many additional indices. For instance, you can compare your levels of production against industry averages and predetermined benchmarks, to identify problem areas and increase herd productivity over time.

Computer software also allows you to compare one cow's performance to the performance of other cows in the herd. This is done by comparing one cow's calf weaning weight relative to her weight, to the same calculation for the other cows. This comparison allows you to select heifer calves from your top-indexing cows and improve your herd genetics sooner. It also allows you to cull the lower-indexing cows during those years when you can afford to cull for poor cow performance or when you are reducing herd inventory. Other traits that should be considered as criteria in determining the final cull list are temperament, structural soundness and poor sexual development. The use of the production reports, coupled with physical observations, is especially valuable when selecting heifer calves into the herd or selling cows to the cull cow market.

Several computer software programs do cow and/or herd analysis. When comparing the various programs, look for ones that serve your needs, are user-friendly and have an acceptable level of dealer support.

The basic information needed for most analyses includes the following:

- breeding season
- individual cow and calf identification
- cow and calf age (i.e. birth dates)
- weaning weight and sex of the calf
- mature weight of the cow

By adding breed of sire and dam, ID of sire, pregnancy check results, date of service, calving ease, calf condition at birth and reason for calf death losses, and by grouping cows into breeding and management groups, much additional information can be included in the analysis. Provision is made in some computer programs to include other farm-specific calculations.

### **GOLD management indicators**

The acronym GOLD stands for: growth of the calves; the number of open cows; the length of calving season; and, calf death loss. Whether you use a computer program or calculate these

indicators by hand, they can be used to evaluate the productivity performance of your beef herd. Using a computer program reduces the amount of time spent doing numerous hand calculations.

### **G for growth of the calves**

This is calculated using the fall weaning weight of the calf as a percentage of the dam's weight. The benchmark level to aim for is 43 per cent of the dam's mature weight. It can also be calculated as the weight of calf weaned per weight of cow exposed. An acceptable benchmark is about 20 kg (43 lb.) of calf weaned per 50 kg (100 lb.) of cow exposed.

The amount that a trait is determined by genetics is called its heritability. Growth, at 30 per cent heritability, is only moderately heritable. This means that weaning weight can be influenced in a major way by non-genetic factors (e.g. pasture condition). A large determinate of weaning weight is the milking and mothering ability of the calf's dam. Actual weaning weight is a good measurement of dam performance as it recognizes the effect of late calving of the cow. By selecting for weaned weight, the growth potential of the calf will rise and the milk production of selected female replacements will rise. Poor producing cows are easy to spot. While a herd can be very productive in terms of individual weaning weights, overall herd productivity may be very low when the percentage of calves weaned per cow exposed or weaning weight as a per cent of cow weight is considered.

Average weaning weight can be used in other ways to evaluate herd management or breeding decisions. You can compare the production of sires, pasture types, breeds and crossbreeding programs, and then take action, on the basis of these comparisons, to correct or avoid management problems. As management levels rise, it may also be beneficial to include in your calculations the costs associated with pounds of gain and develop a measurement of cost per pound of calf raised.

### **O for number of open cows**

This indicates the fertility level of the herd as a whole. It is measured by fall pregnancy testing to determine the number of open cows after the breeding season, as compared to the number of cows exposed. The benchmark is 96 per cent bred after a 63-day breeding season.

Cow fertility is the most important factor in overall herd productivity and can have a great

impact on profitability. Cows that calve repeatedly within 12 months have the greatest benefit on overall herd productivity. Infertility can occur because of malnutrition, disease or infertile genetics. In most cases, the short-term cures are to provide adequate nutrition (see the *Nutrition and Feeding Management* chapter) and to minimize disease through vaccination programs (see the chapters on Calf Management from Birth to Weaning and Animal Health Management). Long-term selection of fertile females from cows that consistently calve in the first trimester or first 21 days of the calving season and the selection of bulls with larger than average testicles, results in a herd that is genetically more fertile.

### **L for length of calving season**

This indicator is measured by the number of days between the first and last calf born after the previous breeding season. It is used to determine the fertility of the cows that became pregnant during the breeding season last year. The benchmark is 63 days or three estrous cycles (21 days each).

The length of the calving season is another good measure of fertility. Being able to achieve an acceptable level of pregnancy in a shorter calving season allows you to market a more consistent calf crop. Consistency simplifies management as well. If your calving season is greater than 63 days, consider shortening it gradually in order to reduce the number of cows that may have to be culled.

If a producer decides to shorten the breeding season from 120 days to 70 days, the length of the previous calving season should be analysed to estimate the number of cows that may be open after the breeding season. Culling a large number of cows can have an impact on your next year's cash flow. It may be better to gradually shorten the breeding season over a couple of years. This can be done by turning the bull out 10 days later and/or removing him 10 days earlier than when the majority of cows became pregnant in the previous breeding season. Follow this sequence for a couple of years until you reduce the calving season to 60 to 70 days. After the first year, most producers only want to shorten the season by timing the removal of the bull.

Once you have your calving season down to around 70 days, you can then start to adjust the calving interval down in a smaller increment

(e.g. five days) until you reach a 63-day season. Then, start adjusting down to a 42-day calving interval (a breeding season two cycles in length) if you want a more limited breeding season.

To analyse the length of the calving season more closely, assess the calving interval of the cows in the herd. If one or a few cows have a long interval between calves, it indicates a problem with them. If several cows have long intervals, it indicates either a management problem or the use of sub-fertile sires.

You cannot really affect calving interval by selecting for it as it has a low heritability. However, it responds directly to management. If high producing cows are the ones with long and inconsistent intervals, they are probably not receiving sufficient feed to meet their high level of production. In that case, improving the nutrition to those females cures their problem. However, if that is not desirable, sell them during years of high demand. Also, cull those cows with consistently long intervals that habitually calve late and raise light, unprofitable calves.

### **D for death loss**

This assesses the health of your herd by measuring the number of calf deaths from birth to weaning. The benchmark is less than four per cent.

The death of calves is measurable and relatively easy to deal with. Calves die during calving, shortly after calving or as suckling calves on pasture. Each of these segments has different causes of death and strategies for remedy. Consult with your local veterinarian, nutritionist and livestock specialist to achieve a system that minimizes calf deaths.

### **Overall herd performance**

With acceptable levels of loss occurring throughout the production cycle, a final benchmark can be used to evaluate overall herd reproductive performance, known as calving percentage. Calving percentage measures the number of calves weaned relative to the number of cows bred the previous season. If the calving percentage slips much below 85 per cent, some area of the production cycle is weak and has potential for improvement. In herds where artificial insemination is practised, services per conception

are a good measure of an individual cow's fertility. On a herd basis, conception rate, expressed as the number of cows that become pregnant as a percentage of those exposed, is also a good measure of reproductive efficiency.

### **PREGNANCY TESTING**

Pregnancy testing is a useful tool for identifying non-pregnant or open cows or heifers. These non-pregnant animals become likely candidates for culling since they will not produce a calf to offset production costs. Pregnancy testing can profitably be used at two different times during the year. The first would be as early as possible (about 35 days) after the breeding season ends and open animals may be rebred or culled. The second time would be in the fall when calves are weaned and before winter feeding programs begin.

Pregnancy is routinely detected in cows by inserting the hand into the rectum and palpating through the rectal and uterine walls for fetal membranes or cotyledons within the uterus. Well-trained persons can detect pregnancy about 35 days after insemination, but accuracy is considerably improved by waiting until 40 to 50 days. Ultrasonic detection of pregnancy can be accomplished in cattle by inserting the transducer into the rectum and directing sound waves toward the uterus. Pregnancy has been detected during the second and third week after conception, but the rate of detection is poor until the fourth or fifth week of gestation. The use of real-time ultrasound, where a moving image is displayed on a screen, is limited because of the expense of the instruments.

Pregnancy testing gives an early warning of breeding trouble, such as females that have problems breeding or infertility in bulls. It also makes it possible to separate and group the cows as pregnant and cull cows. This provides an opportunity for proper nutrition management of each group and effective use of facilities during all seasons of the year, particularly at calving time. It also makes it possible to guarantee pregnancy on females that are for sale.

### **DEVELOP A CULLING PROGRAM**

Proper culling of the beef herd after the breeding season improves reproductive performance. All breeding females should

be pregnancy tested by a veterinarian at/or following weaning. Generally, all open cows and heifers should be culled. In addition, pregnant breeding females should be visually examined for soundness. Those with conditions such as lumpy jaw, cancer eye, mastitis, poorly attached udders, poor feet and legs, reproductive problems or bad temperament should be culled. Often, these are older cows that are approaching the end of their productive lives. Culling non-pregnant and poor health risk cows directly improves calf crop percentages and minimizes health related losses.

A final, additional cull should be made on the basis of performance. Cows that produced low indexing calves at weaning should be culled because a low growth index is indicative of poor milking ability or poor genetic quality. The severity of culling depends on the individual value of the breeding females, as well as the total number of cows the producer wishes to retain in the herd. Heifers from cows culled for physical defects or low performance should not be selected as breeding stock.

## **Developing Replacement Heifers**

A key to producing top quality, fertile cows involves proper management of the cow from the time she is a calf. To produce the maximum number of calves in her lifetime, a cow must calve each year, starting as a two-year-old. From birth on, the decisions in the care and management of the heifer influence her ability to conceive and rebreed each year. Replacement heifers should be managed to reach puberty early, conceive early in the first breeding season and breed back early for their second calf.

Select the larger heifer calves at weaning time to be kept as replacement heifers. Weaning weight is a function of genetics and a cow's ability to give milk. Usually, larger calves come from the higher producing cows and they are usually also older, thus chances of early conception are higher. Heifers that are light at weaning or that aren't allowed or able to gain adequate weight from weaning until breeding will fail to show heat at the desired time. Larger heifers at weaning tend to breed earlier than smaller heifers (Zollinger and Carr 2002).



*Large heifers make good replacements.*

As each year's heifers enter the cow herd, their performance as a group influences the reproductive efficiency of the herd as a whole and should provide sound genetics to the core of the cow herd and allow you to cull out below average producing cows from year to year.

The following aspects of heifer rearing need to be considered to maximize the reproductive levels in your herd.

## Puberty

Puberty is defined as the time at which a heifer shows a fertile estrus and develops a corpus luteum (a hormone-secreting structure that develops

in an ovary after an ovum has been discharged) necessary for sustaining pregnancy. This is when the heifer becomes capable of reproducing.

Puberty occurs between six and 14 months of age. The age and weight at which a heifer reaches puberty is influenced by several factors including level of nutrition, breed, growth rate and heterosis (crossbreeding effect). There is a marked difference in age at puberty among breeds (Table 13). The British breeds tend to reach puberty earlier than exotic breeds, which attain a higher body weight.

Heifers that are older and heavier at weaning and at breeding make a better choice for herd replacements. Younger and lighter heifers are likely to reach puberty later than older and heavier heifers. Heifers that reach puberty later in their first breeding season calve later and return to breeding later as two-year-olds. Since the return to estrus is about 80 to 90 days for heifers (20 to 30 days longer than for older cows), heifers that calve late in their first year tend to always calve later.

TABLE 13. Effect of breed on age and weight at puberty

Breed of sire	Heifers reaching puberty at 15 months (%)	Average age at puberty (days)	Average weight at puberty	
			(kg)	(lb.)
Hereford	96	375*	275 - 300	605 - 650
Angus	97	353	260 - 300	575 - 650
Hereford x Angus	97	377	275 - 300	605 - 625
Brown Swiss	97	347	275 - 300	605 - 650
Brahman	80 - 95	400 - 412**	320 - 340	700 - 750
Charolais	96	399	300 - 320	650 - 700
Chianina	60 - 85	398 - 455	320 - 340	700 - 750
Devon	98	385	275	605
Gelbvieh	95 - 99	341 - 365	275 - 300	605 - 650
Holstein	99	369	275	600
Jersey	92	328 - 368	215 - 275	475 - 600
Limousin	92	399 - 402	300 - 320	650 - 700
Maine Anjou	99	371 - 402	300 - 310	650 - 675
Pinzgauer	96	309	275 - 300	605 - 650
Red Poll	95 - 100	360 - 368	260 - 300	575 - 600
Simmental	95	369 - 375	285	625
South Devon	87 - 95	365 - 382	275 - 310	605 - 675
Tarentaise	100	326	275 - 300	605 - 650
Shorthorn			260 - 300	575 - 650

Sources: USDA (1973 - 1977), Anonymous (1985). \* 375 days = 12.3 months. \*\*412 days = 13.6 months



The United States Meat Animal Research Center has studied the age and weight of heifers at puberty as one aspect of breed comparison studies. The results of these studies indicate that crossbred heifers of the exotic breeds should be at least 14 months of age in order to have a higher percentage of the heifers cycling when the breeding season begins. In addition, they should be in the 340 to 350 kg (750 to 775 lb.) weight range when breeding commences (Table 14). Most British breed heifers should be a minimum of 14 months of age and in the 295 to 320 kg (650 to 750 lb.) weight range at the start of the breeding season.

## Feeding and Breeding Yearling Heifers

Inadequate nutrition reduces the number of heifers showing estrus at breeding time. This can result in more heifers being open at the end of the breeding season. The development of heifers to attain reproductive efficiency can be accomplished by ensuring that adequate energy and protein are supplied in their growing ration (see the *Nutrition and Feeding Management* chapter for grain-roughage combinations).

Depending on breed type, replacement heifers must gain between 0.7 and 1 kg (1.5 and 2.2 lb.) per day from weaning to the start of the breeding season. A growth benchmark for feeding replacement heifers is that a heifer should weigh 60 to 65 per cent of her mature weight by breeding time. To successfully breed, heifers at 14 to 15 months of age should attain the minimum weights shown in Table 14.

Be careful not to overfeed yearling heifers. This results in excessive fatness at the time of puberty. Fat collects in the mammary area of the heifer, causing the fat cells to displace milk tissue. This permanently damages the heifer's potential to produce milk.

Because some of the heifers will not cycle, put 50 per cent more heifers out to breed than are needed. By limiting these heifers to a 45-day breeding season, only the most fertile heifers become pregnant, resulting in early calves born the following spring. Calving early gives the first-calf heifer the necessary time to prepare for rebreeding with the main herd the following year. If more replacement heifers are in calf than are required to replace culled cows, the heifers themselves can be culled based on their pre-weaning test records.

## Reducing Calving Difficulty in Heifers

Calving difficulty is known as dystocia. Its principal cause is feto-pelvic incompatibility; that is, the calf is too large for the dam. Dystocia is most common in heifers and it is often associated with larger calves. Heritability of birth weight is 50 per cent. Therefore, fetal environment and nutrition are responsible for the remaining 50 per cent. For more information on dystocia, refer to the *Calf Management from Birth to Weaning* chapter.

Limiting nutrition during pregnancy has only a minimal effect on lowering birth weights unless energy is severely restricted. Even when low levels of energy are fed, calving difficulty is not likely to

TABLE 14. Recommended minimum weights at first breeding

Breed	Weight	
	(kg)	(lb.)
Hereford	294 - 318	650 - 700
Angus	294 - 318	650 - 700
British x British	294 - 318	650 - 700
Charolais, Simmental, Maine Anjou, Limousin, etc.	340 - 362	750 - 800
Continental x British	340 - 362	750 - 800

Adapted from: Zollinger and Carr (2001)



be reduced. One example of this is illustrated by a study conducted in Australia with heifers fed three different energy levels over the last 120 days of pregnancy (Table 15). Part of the reason calving difficulty is not reduced is that the restriction of energy also impairs the heifer's growth, resulting in a smaller pelvic opening in the lower plane (LP) and maintenance plane (MP) groups. Furthermore, the calves from the LP group of heifers took three times as long to stand and suckle after birth than did the calves from the high plane (HP) group. Reproductive performance in the MP and LP groups was also inferior to the HP group.

TABLE 15. Effect of nutrition on birth weight and calving difficulty in heifers

	High plane (HP)	Maintenance plane (MP)	Low plane (LP)
Average daily gain of heifers 12 weeks pre-calving	0.70 kg (1.5 lb.)	-0.13 kg (-0.29 lb.)	-0.56 kg (-1.23 lb.)
Calf birth weight	29.9 kg (66 lb.)	26.8 kg (59 lb.)	23.4 kg (51.5 lb.)
Total dystocia cases/total calving	3/49	3/49	6/48

Source: Kroker and Cummins (1979)

Based on this and other research, it is important that heifers be well grown out before their first calving to avoid calving problems, maximize calf survivability and ensure that rebreeding occurs within 60 to 90 days after calving. Heifers should be 85 per cent of their mature weight by first calving time (Zollinger and Carr 2001).

## Selecting Appropriate Bulls for Heifers

A young bull is preferable to use on heifers. This reduces the risk of injury to the heifers as younger bulls weigh less than mature bulls. To minimize calving difficulties, select a bull that comes from a sire with a record for easy calving. The bull should be one that was born unassisted, with a light birth weight and with a fine-boned structure. If an older bull is used, he should have a record for easy calving. Use expected progeny difference (EPD) calculations for the best information on the family history of the potential bull (see the *Genetic Merit* section in this chapter and the *Genetic Improvement Methods* chapter for more information on EPD). It is more important to select an easy calving bull with sound EPD values within the chosen breed than to select a breed for easy calving. In general, sires from British breeds cause fewer calving problems than many of the larger European breeds.

## Care of First-calf Heifers

The first lactation is probably the most critical time in a cow's life. A two-year-old, first-calf heifer needs feed for both growth and milk production, on top of that required for maintenance. Growing heifers and young lactating cows need high quality feeds to continue growing to their mature weight.

It is very important to make sure first-calf heifers get enough feed. Special arrangements should be made to supply them with adequate nutrition between calving and the time of adequate pasture. The only time it is not necessary to supply these young cows with more feed than the rest of the herd is when pastures are good.

Breed heifers to calve about two to three weeks before the cow herd. This allows you to devote extra time and attention to heifers during calving. This also gives the heifers extra time to recover after calving so they rebreed with the main cow herd. Beef cattle calving in the first three weeks of the calving season will more readily rebreed in the subsequent breeding season. If heifers calve late in the calving session they usually breed back late in the breeding season, if at all.

## Selection and Reproductive Management of Bulls

The bulls selected to breed a herd represent a large investment and influence the productive returns from the herd for many years. The herd bull not only affects the number of calves born, but also the duration of the calving period, calving ease, the growth rate of the calves and eventually the genetic potential of the herd as determined by his daughters. Cows and heifers conceiving early in the breeding season are the ones that produce red meat the most economically. Proper care and management of bulls are important to getting cows and heifers bred efficiently.

### Bull Selection

When striving for a fertile, productive cow herd, a balance between reproductive and production traits should be maintained when selecting a herd bull. Reproduction and production do not always follow hand in hand. Bulls showing traits that influence reproduction may not produce the best growing calves. On the other hand, bulls that have strong genetics for producing large calves with superior carcass qualities may not produce daughters that will match the management and environment of your farm. Determine the needs of your herd in advance of selecting a breed type. Consider having a combination of bulls to produce future daughters for the herd, as well as calves that are strong in the growth and carcass traits that meet the needs of the feedlots.

*Match your bull to your herd needs and goals.*



Sire selection is a major tool for changing the genetic potential of a herd. The following factors should be kept in mind when evaluating a potential herd sire for your breeding program:

- genetic merit
- physical condition and health
- breeding soundness

### Genetic Merit

The genetic merit or potential of a bull can be estimated from his performance and progeny. A bull's performance should be at least equal to the average of the herd from which he was produced, equal to the average of a group of bulls on test and better than the performance of your herd. Only those traits that are medium to high in heritability and economically important should receive major consideration in a breeding and selection program. Do not select for traits that are of low heritability and non-economic, as these contribute little to beef production.

Advances in genetic evaluation of cattle have made estimating a bull's genetic worth more accurate than ever before. When selecting a herd bull, look for an animal that, based on pedigree and performance or progeny information, has the ability to pass on desirable qualities (genetic traits) to his offspring. The use of expected progeny differences (EPD) allows you to predict the performance of future progeny of a bull. EPD values are an estimate of the performance a bull will transmit to his calves as a result of his genetic traits.

EPD values are expressed in the same units as the trait they describe (e.g. birth weight, milk or pounds of gain). They are calculated based on the genetic traits of the bull and his relatives. A bull's EPD value for a genetic trait, such as birth weight, is a more accurate estimate of his genetic worth than weight or adjusted weight. As the bull has more offspring from several farms, the EPD calculation becomes more accurate and more predictable. EPD values also allow you to compare expected performances between bulls within a breed. For example, by using EPD values for birth weight and weaning weight, producers can compare bulls for producing calves with acceptable birth weights and good growth performance while nursing on the cow. To compare

animals across breeds, adjustment factors have been developed (refer to the *Comparing Animals Across Breeds* section in the *Genetic Improvement Methods* chapter for more information).

In addition to selecting for genetic traits by using EPD values and phenotype (physical appearance), a bull must also be able to sire a large number of calves during a short breeding season and remain healthy for a number of breeding seasons. Young bulls have a greater genetic potential for improvement of the cow herd than do older bulls. However, young bulls have a higher potential for breeding problems during the breeding season. Problems that can occur are open cows, extended calving seasons and lighter calves at weaning. Therefore, proper care and management of bulls is important to getting cows and heifers bred efficiently. Bull management is an ongoing job, and an understanding of functional reproductive physiology and management is important in selecting and managing a fertile bull battery.

The age at which a bull reaches sexual maturity or puberty varies widely between and within breeds. Most bulls will reach puberty at 10 to 14 months of age, although it is common for a bull to have the desire and ability to mate at as young as seven months of age. As puberty approaches body conformation changes, aggressiveness and sexual desire increase, and the penis and testes grow rapidly.

Generally, the British breeds reach puberty earlier than the larger exotic breeds. Underfeeding of bulls results in delayed puberty. While puberty is generally reached at one year of age, the breeding ability of bulls is usually at its highest between one and a half and two and a half years of age and declines after five to six years of age. Often an extra calf crop can be sired by using younger bulls as yearlings.

Remember that young bulls continue to grow and develop after the breeding season ends. For this reason yearling and two-year-old bulls should not be overused and should be kept on a plane of nutrition that allows continued growth of frame and muscle.

## Physical Condition and Health

### PHYSICAL CONDITION

The potential bull should have an ample amount of bone, adequate skeletal size as indicated by height and body length, and better than average

muscling, and be in good condition. The bull needs to be able to see, eat, smell and move around to successfully breed his share of cows. Any factor that lowers the efficiency of these activities will have a negative effect on the bull's breeding ability.

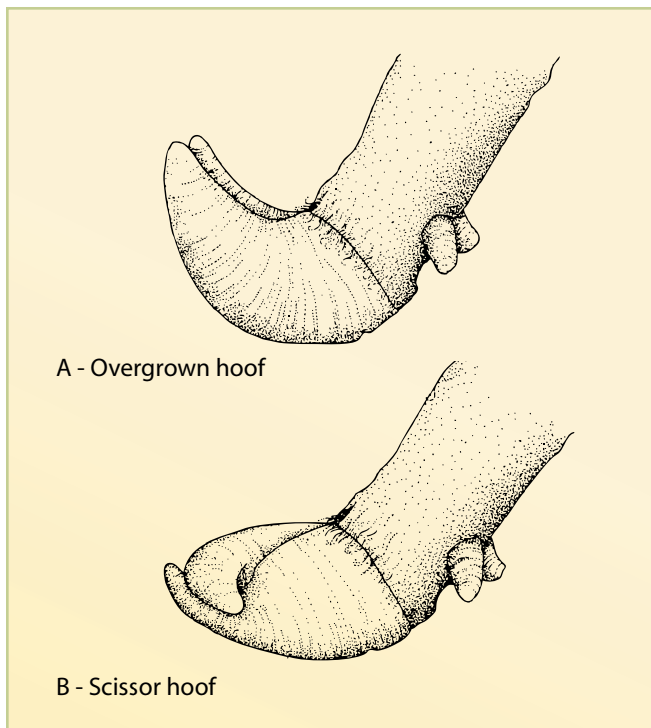
Check older bulls to make sure no teeth are missing and that the teeth are not severely worn. Lumpy jaw is a chronic bone and soft tissue infection, and bulls should be culled as soon as the condition is diagnosed.

Check older bulls to make sure that their eyes are free from injuries or disease. Special care should be taken to examine eyes for early cancer eye growth. Also check that old pinkeye scars are not causing any loss of vision. If a vision problem is identified, the bull should be culled, especially in multiple sire groups.

Individual farmers often have different visions of what the correct body condition for a breeding bull should be. However, bulls should have enough body condition to be strong with some reserves of energy in the form of fat. The required amount of condition varies with age, size of range or pasture, topography, feed conditions, length of the breeding season and the number of cows per bull. A body condition score of 3.0 to 3.5 is desirable for bulls entering the breeding season. The skeletal structure is difficult to identify, there are obvious fat deposits behind the shoulders, the ribs feel spongy and fat cover around the tail head is evident.

### Feet and leg problems

Structural soundness of the feet and legs is vital if the bull is to travel and mount females in heat. A bull that is either sore or crippled will not be able to perform under range or pasture conditions. Any bulls showing signs of arthritis, such as stiff gaits or swelling of joints should be culled. Structural defects of the feet and legs should be identified during the breeding soundness evaluation and the animal should be culled. Poorly conformed feet and legs (e.g. sickle-hock) are heritable and eventually show up in the daughters, shortening their productive lives. A young bull with overgrown hooves should be culled. A mature bull with an overgrowth of the horny hoof should have his hoof trimmed (see next section). If you intend to sell all the offspring as terminal cattle, feet and legs are not an issue.



**FIGURE 13.** Hoof deformities

## Hoof trimming

Mature bulls may suffer from an overgrowth of the horny hoof (Figure 13) that requires trimming. The extra growth on the hoof makes it difficult for the bull to move around in search of cows in heat and can seriously affect a bull's reproductive capacity.

Hoof trimming is probably most profitably carried out in the spring. Professional hoof trimmers may be employed. Alternatively, producers can effectively trim hooves if they are willing to equip themselves with the proper facilities, tools and training.

**Facilities:** When only a few animals are trimmed during a year, producers often utilize their current chute systems. However, producers who trim many animals every year frequently choose to invest in a hoof-trimming table.

**Equipment:** Equipment required for hoof trimming includes the following:

- a heavy-duty rotary sander to make the task easier

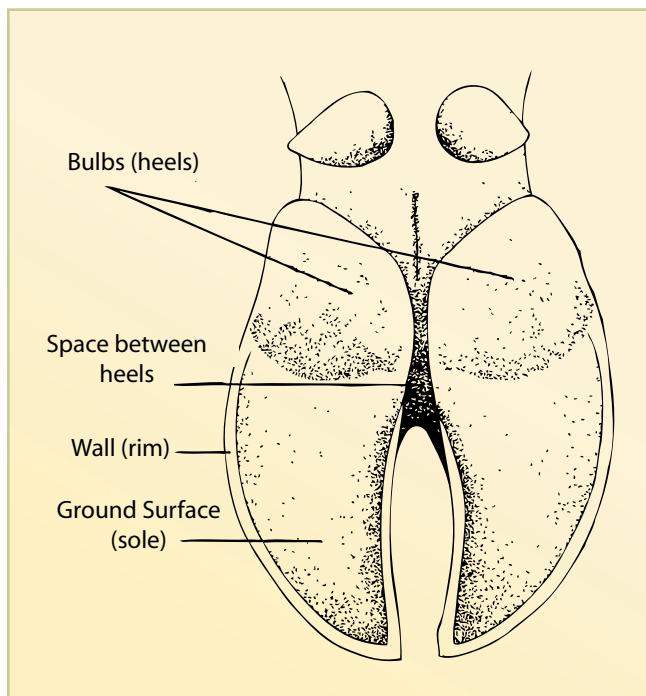


*A rotary sander makes hoof trimming easier.*

- both left- and right-handed hoof knives and a sharpening file
- Coppertox, iodine and disinfectant bandages

**Hoof anatomy and technique:** The sole of the hoof is normally concave with the outside rim of the hoof bearing the weight of the animal (Figure 14). Overgrowth of the horn-like material destroys this arrangement. After hoof trimming, the outer rim of the hoof should be left slightly longer than the edges next to the cleft between the toes.

Be careful not to cut the toes off. Try to remove the horn from under the toes until the length of the hoof approaches normal. The horn under the heel is normally thicker than at the toe. Excessive paring in the heel region may lead to damage of the sensitive structures under the sole.



**FIGURE 14.** Parts of the hoof



## HEALTH PROBLEMS AFFECTING REPRODUCTIVE ORGANS

Infection and inflammation can occur in any of the reproductive organs. If the testicles become inflamed, the semen quality may be impaired long after the original condition has passed. It takes about 60 days for new sperm to be produced and mature.

A variety of other conditions can affect the function of the reproductive tract. Semen quality may suffer if the testicles cannot move because of scar tissue or fat pads. If the proper temperature cannot be maintained, semen quality will also suffer. Soft testicles indicate poor semen quality and degeneration of tissue. Very small testicles indicate unsatisfactory development of sperm-producing tissue. Abscesses, tumours or severe frostbite scabs also indicate potential problems.

Penile problems that can occur include persistent frenulum (tied back penis), spiral deviation and penile hair rings. The most common problem is spiral deviation, where the penis is twisted instead of straight. Bulls with this defect produce fewer pregnancies than normal bulls and should be culled. A persistent penile frenulum is a heritable condition. The tip of the penis remains attached to the sheath and cannot be extended. It can be surgically corrected. Penile hair rings occur when a band of hair encircles the penis. They are most often seen on young bulls. If the condition is not treated, infection and scarring may result. Other penis problems include warts, fractures and scarring from previous injuries.

Injuries to the penis usually occur during the active breeding season, but may be resolved enough to be missed until the breeding soundness exam. Old adhesions and lacerations can prevent the penis from becoming fully extended or cause pain during breeding. Bulls with any type of painful lesion will usually quit trying to breed cows.

### Breeding soundness

A breeding soundness examination is critical to ensuring the success of the breeding season. It should be performed 30 to 60 days before the breeding season is to start. It should evaluate a bull's testicular and scrotal development, semen quality and physical soundness (feet and legs).

A successful test indicates that an individual bull on the day of the test is equipped to be successful at breeding time. Disease, injury and lack of mating desire can prevent a bull from performing at the desired level.

Surveys conducted in Canada, the United States and Australia indicate that 20 to 40 per cent of the bulls examined for breeding soundness were sterile or had reduced fertility. A bull can be in good physical condition and have normal reproductive organs and still have low fertility due to poor semen quality. With the high cost of purchasing and maintaining bulls, producers can't afford to compensate for reduced fertility by running extra bulls in multi-sire breeding pastures. Bulls that do not settle their share of cows early in the breeding season are contributing to reproductive inefficiency.

By implementing breeding soundness examinations prior to the breeding season, bulls of questionable or unsatisfactory breeding potential can be eliminated. This procedure improves the chance of having an early, short calving period resulting in a greater number of heavier calves at weaning. It is important to carry out a breeding soundness evaluation early in the spring. This allows for culling or changes in your bull inventory, without compromising the selection from this year's crop of bulls or spring bull sales.

Most seed stock producers and bull sales now carry out some kind of routine breeding soundness examination. This type of evaluation gives some assurance that the bulls are equipped and ready for breeding a high percentage of fertile cows.

*Collecting semen for evaluation.*





TABLE 16. Relationship between semen quality and conception rate during natural mating

Normal sperm in semen (%)	No. of bulls	Cows bred	Cows conceiving	Conception rate (%)
76 - 95	27	339	192	57
60 - 75	6	90	53	59
40 - 60	9	139	55	40
Less than 40	9	126	37	29

Source: Wiltbank et al. (1965)

## Semen quality

The quality of semen produced by the testicles is very important. A high percentage calf crop largely depends on using males capable of producing high fertility semen. Bulls with poor semen quality as measured by the percentage of normal sperm have low first estrus conception rates (Table 16).

The firmness of the testicles provides an indication of the quality of semen produced. Testicles that are firm when manually palpated generally produce good quality semen. Testicles that are hard or very soft are suspect and may have been injured. However, an accurate evaluation of semen quality can only be obtained by examining a semen sample through a microscope. A breeding soundness examination should be done which includes a semen evaluation.



A microscope is used to check semen quality.

Semen quality can be determined by collecting a representative semen sample with an electro-ejaculator or artificial vagina. The sample is then evaluated with the naked eye and microscopically for colour, volume, concentration, motility and morphology. Only qualified veterinarians and technicians should collect and evaluate a semen sample. There is no accurate, repeatable method of measuring actual semen concentration with samples collected with an electro-ejaculator.

## Scrotal circumference and shape

Scrotal circumference (SC) is a valuable measurement. It correlates well with daily sperm



Scrotal circumference tape.

production and semen quality traits (motility, per cent normal sperm, total sperm output and abnormalities). Bulls with larger testicles tend to produce more semen, sire sons with bigger testicles and sire daughters that achieve puberty earlier and are more fertile.

Scrotal circumference appears to be highly heritable and the measurement has been shown to be highly repeatable when comparing measurements on the same animal taken by the same person or by different people. Scrotal circumference measurements also show breed differences, as well as considerable variability among bulls within breeds.

Scrotal shape has an influence on testicular development and function. There are three basic scrotal shapes in beef bulls: bottle-shaped, straight-sided and wedge-shaped. Bulls having a bottle-shaped scrotum with a distinct neck generally have the best testicular development. This is important because the testicles are raised and lowered by muscles in the wall of the scrotum and the spermatic cord to maintain a constant temperature for proper sperm development.

The testicles have two primary functions: to produce sperm and to produce testosterone, the

male sex hormone. Testicular growth is very rapid during the period from six to 14 months of age. Bulls should be fed well during this period because a low level of nutrition results in slow testicle growth and small testicles at maturity.

Research has shown that testicle size, as measured by scrotal circumference, is closely related to sperm production. In other words, bulls with larger testicles can successfully mate and settle more cows than bulls with smaller testicles. A number of studies have also indicated that a bull's age and weight have a great effect on testicular development and size up to puberty. While the relationship between testicle size and semen production is not as great after reaching puberty, larger bulls generally have larger testes than smaller bulls of the same breed.

Studies conducted at the University of Saskatchewan indicate that the probability of a bull having satisfactory seminal quality increases as SC increases until an SC of about 38 cm is attained. Of 155 bulls having an SC of 32 cm, only 13 per cent were considered to have satisfactory semen quality. In contrast, 88 per cent of 136 bulls with an SC of 38 cm were classified as having satisfactory semen quality.

The breed, age, weight and fleshing of the bull must be taken into consideration when using the scrotal measurement as an estimate of semen producing ability. Table 17 indicates recommended minimum scrotal circumferences for common beef breeds, at various ages.

Breeders, breed associations, veterinarians and researchers have established minimum scrotal measurements that a bull must meet to pass a

## Measuring scrotal circumference

The scrotal circumference of a bull can be easily and accurately measured using a commercially available flexible cloth or metal tape measure. After restraining the bull in a head gate, the testicles should be gently grasped at the neck of the scrotum. The testicles can then be pulled firmly down into the base of the scrotum by encircling its neck between thumb and finger and pulling down on the testicles. The scrotal tape is formed into a loop, slipped over the scrotum and pulled snugly around the greatest diameter of the scrotum for a reading.

breeding soundness examination (Table 17). While these measurements are a good guide, they are not a guarantee of a fertile bull. However, bulls below the recommended minimum standard circumference should be culled and not used for breeding purposes. Industry has historically followed the guideline that yearlings and two-year-olds with less than a 30-cm scrotal circumference are likely sub-fertile. If these bulls are used for breeding, the result is likely to be a low conception rate and a lengthy calving period.

The greatest long-term benefit of using bulls with above average testicular size relates to the daughters of that sire. Fertility and/or age at puberty of heifers can be predicated from testicular measures on bulls to be used as sires of these heifers. Studies from both Colorado and Montana State Universities show strong ties between the testicular size of bulls and when their daughters reach puberty. A high percentage of heifers sired by bulls with a scrotal circumference of 32 cm or larger at 12 months of age will cycle to calve by 24 months of age. Results from a more recent study in North Carolina indicate

TABLE 17. Recommended minimum scrotal circumference for various breeds of beef bulls at different ages

Age (months)	Recommended minimum scrotal circumference (cm) by breed of bull			
	Simmental <sup>1</sup>	Angus and Charolais	Hereford and Shorthorn <sup>1</sup>	Limousin
12 - 14	33	32	31	30
15 - 20	35	34	33	32
21 - 30	36	35	34	33
>30	37	36	35	34

<sup>1</sup> Approved by Canadian Simmental and Shorthorn breed associations. Source: Coulter et al. (1987)

a strong correlation between testicle size and improved fertility throughout the daughters' lifetime. It is speculated that the hormonal composition of the bull that leads to larger testicles is passed on to the daughters and is reflected as early puberty and higher fertility in these female progeny.



*A healthy bull: ready for breeding.*

## Reproductive Management of Bulls

The proper care and feeding of the herd sires, especially yearling bulls, is important to ensure optimum breeding performance over a number of years. Bull management and care is an ongoing process. Make sure your bull management program includes consideration of the following before, during and after the breeding season:

- breeding system and facilities (pastures)
- bull social behaviour and dominance
- bull-to-cow ratio (bull power)
- breeding nutrition (especially for young bulls)
- breeding soundness exams
- assessment of disease risk

## Breeding Systems and Facilities

The breeding system and facilities help to determine the success of the breeding season. Before the breeding season, review how and where the cows and heifers will breed and what bull(s) they will be exposed to. Review of the facilities should include fences, natural barriers, water, forage supplies and corrals and working areas.

During the breeding season, evaluate how well the breeding system and pastures are actually working. Fences and natural barriers should be strong enough to limit encroachment by other bulls and keep each bull in his own pasture. Make sure the forage and water supplies are adequate to meet the nutritional needs of a particular group of animals. Make corrections as soon as possible but, if it's too late for the current year, make a note of changes that are required for the next year.

## Bull Social Behaviour and Dominance

Bulls do most of the “finding” of a mate, so they need the freedom of movement to find and mate with receptive cows. Bulls, especially young bulls, make several adjustments when they are turned into a new environment. It may take several days for bulls to acclimate themselves to their new environment.

Yearling bulls must undergo both a learning process and acclimation to their new home before exhibiting sexual behaviour. Young bulls show more sexual activity, including mounting and achieving at least one service, while in groups of three or more. Large, single sire breeding pastures with yearling bulls may negatively impact early season mating and conceptions (Zollinger et al. 2002).

Social dominance or aggressive behaviour by some bulls can influence the performance of less dominant bulls and limit mating desire, conception rate and number of calves sired by each bull. Bulls that have been used more than two breeding seasons may become very territorial and use significant time and energy fighting to keep their territory. Fighting to keep territory may reduce the amount of time bulls spend servicing cows. When possible, new bulls should be introduced into herds slowly to prevent possible injuries.

When running several bulls in a herd, the selection of which bulls to run together is critical. Social ranking, generally based on the age or size of the bulls, influences the breeding activity in a large breeding herd. For any group of bulls to function satisfactorily, ranking must be definite. If the dominance between bulls is vague, bulls spend energy fighting for the dominant position rather than spending their energy and time with the cycling cows.

Select bulls where dominance is definite. Then, if possible, select your breeding groups in such a way that your desirable bulls are the dominant ones. Place your remaining, less desirable and recessive bulls into that herd. Because dominance is such an important aspect of mating behaviour, having less dominant bulls present in the herd spurs the dominant bull to greater levels of breeding activity. The less dominant bulls then breed the extra cows that the main bull could not physically get to.

## Nutrition

Proper levels of nutrition are important for bulls, especially young bulls during sexual development. Both underfeeding and overfeeding can cause problems. Aim to have yearling bulls gain at about 0.9 to 1.1 kg/day (2 to 2.5 lb./day) and to be at a body condition score of 3.5 for their first year of service. For mature bulls, aim for a score of 3 to 3.5 (good to very good) at the beginning of the breeding season. Bulls that are not adequately fed may have reduced growth and skeletal development. Poor nutrition may also cause a reduced level of sperm production and motility. This reduces the overall fertility of the herd.

Overfed bulls can be affected by various problems. Yearling and two-year-old bulls that are on a very high plane of nutrition often suffer from temporary sterility and low levels of fertility. Over-fat bulls (BCS 4.5 or greater) deposit fat in the scrotum. This fat insulates the testes so they are not as cool as they need to be. This results in poor production of sperm, as well as numerous problems associated with sperm motility and structure. In most cases, bulls that have been on too much energy eventually suffer from hoof and

leg problems. A combination of laminitis and carrying too much weight also causes excessive stress on the feet.

Older bulls require adequate levels of vitamin A for optimum semen production. Green growing forages are high in vitamin A. However, if your breeding season starts before there is a good supply of green growing forage, supplement your bull ration with vitamin A to ensure adequate diets. Or give all your bulls a vitamin A shot one or more times during the winter. Bulls should also have access to a free-choice mineral containing calcium and phosphorus year round.

Provide about 0.6 m (2 ft.) of feeder space per bull when they are fed from a feed trough. High energy range pellets or cubes can be fed on the ground and can eliminate the need for bunks. Make sure all the bulls have gathered at the feeding area before feeding any grain. This helps reduce the chance of any one bull over-eating and ensures that each bull gets his fair share.

Refer to the *Nutrition and Feeding Management* chapter in this manual for more information on feeding bulls.

## Bull-to-cow Ratio

The age of the bull affects the bull-to-cow ratio. Traditionally this ratio has been one bull to 25 to 30 cows. For a 60 to 70-day pasture breeding season, the bull-to-cow ratio shown in Table 18 can serve as a general guideline.

The size of pasture, topography (landscape's shape), length of breeding season and condition of the bull also influence the number of bulls needed to service the cows. There is evidence that cows find the bull when they cycle. Hilly or rough terrain, sparse or dense vegetation and larger pastures limit the number of cows a bull can breed.

TABLE 18. Bull-to-cow ratio

Size or age of bull	Cows per bull
Yearling	10 - 20
2-year-old	20 - 30
3 years and over	30 - 40



## Canadian Cattle Identification Program

Young bulls have higher nutritional requirements than older bulls. If young bulls are at a low level of condition at the beginning of the breeding season and pasture is sparse, some supplementation may be required. An alternative is to use young bulls for shorter periods of time and rotate groups of bulls during the season. Young bulls are still growing and leaving young bulls with the cow herd for more than 70 days may seriously reduce their body condition.

Where possible, give bulls a three- to four-day rest every 10 to 14 days, particularly if yearlings are being used. Resting of bulls is a good management practice that can extend the breeding capacity of the bull battery as a whole.

A short breeding season of 60 to 70 days is recommended to avoid a spread in calf age and weight at weaning. Observe the bulls when they are with the cow herd. Bulls that are not mating because of injury or lack of desire should be removed from the breeding herd.

### Disease Risk

Transmissible diseases should always be of concern when bringing new bulls into the herd. Trichomoniasis is a venereal disease that can be responsible for poor reproductive performance in a cow herd. This disease causes cows to abort within the first four months of pregnancy.

Trichomoniasis is caused by a one-celled protozoan that is found in the sheath of bulls and reproductive tract of cows. Once it infects the cow, it kills the embryo, which is then aborted (for more information refer to the *Animal Health Management* chapter). The cow will cycle two or three times and then become fertile again. This immunity will last about one year. Once mature bulls become infected, they are always infected and can infect susceptible cows every breeding season.

Producers need to have all breeding bulls tested annually for trichomoniasis. Bulls testing positive should be culled and sold immediately. Bulls should be purchased only from herds and sales where high health standards exist. Bulls should be examined and tested by a veterinarian before purchase and should come with a breeding soundness examination.

Since July 1, 2001, the Canadian Cattle Identification Program has been in place. It is administered by the Canadian Cattle Identification Agency (CCIA). This mandatory program involves the individual identification of all cattle that move beyond their farm of origin, including those going to community pasture, exhibition site, test station or veterinarian clinic (unless going to an approved tagging site). Each animal must have an approved ear tag bearing a number that is unique to that animal. This number is maintained up to the point of carcass inspection at the packing plant.

Bar-coded plastic tags were the first type of identification tags used in this program. The CCIA introduced the mandatory use of radio frequency identification (RFID) tags as of January 1, 2005. This transition is one of many enhancements necessary to meet the post-BSE requirements to further improve the quality and efficiency of the national trace-back system.

As of September 1, 2006, all cattle leaving their herd of origin must have a CCIA-approved RFID tag applied to the ear. Bar-coded tags will continue to be recognized until December 31, 2007, in order to facilitate the movement of cattle that have left their herd of origin prior to September 1, 2006. To facilitate the transition to RFID, bar-code tags will continue to be recognized until December 31, 2007 and recognized on mature breeding stock indefinitely.

After extensive field and laboratory trials to evaluate retention, readability, mechanical and physical characteristics, the following seven RFID tags have received approval: Allflex FDX, Allflex HDX, Destron Fearing ear tag FDX, Nedap D40 cattle tag FDX, Reyflex FDX, Y-TEX TechStar II tag FDX and Z-Tags 2 in 1 tag.

The CCIA-approved tags will bear the CCIA trademark consisting of the three-quarters maple leaf with the letters "CA." In addition, a visual 15-digit number will also be displayed on the exterior





*All animals need to be properly tagged.*

of the tag. If you have any questions, please contact the CCIA office by phone 1-877-909-2333 (Beef), e-mail [ccia@cattle.ca](mailto:ccia@cattle.ca) or visit the CCIA website at <http://www.canadaid.com/>

Age verification is the association of animal birth date data with an animal identification number (single tag or tag group). The CCIA has enhanced its Internet-based Cattle Tracking System to improve the ability of individual producer's ability to verify a calf's birth date. The CCIA has built a database that allows producers to voluntarily register birth dates on individual calves or the whole calf crop. Canadian cattle producers can now register and submit information such as exact birth dates or a calving start date associated with a tag range on a voluntary basis by logging on to the CCIA website (<https://www.clia.livestockid.ca/CTS/>). To register on the website, cattle producers must provide their name and address, as well as a CCIA tag number registered to them. Confidentiality of information is maintained. Once birth date submission is complete, producers can choose to generate specific birth certificates as needed. Cattle producers without access to the Internet are encouraged to submit their information through someone who has access.

Note: When purchasing your CCIA tags for the current year calf crop, request that the tags are in sequential order. This will make your birth date submissions easier.

Canada's international trading partners are proposing age verification information as a prerequisite for export. By registering online and submitting information such as birth dates, producers are re-enhancing the industry's capability to compete in international markets.

As RFID technology advances, it will provide the Canadian cattle industry with further automation of data collection and the ability to easily transfer necessary farm management information quickly and accurately. The advantages of RFID arise from the ease and speed of record keeping, reduction of paperwork, elimination of recording errors and elimination of "line-of-sight" reading, when used in conjunction with an RFID reader. Long-term advantages to the Canadian Cattle Identification Program will enable the industry to implement full animal movement tracking through the use of RFID and reader technology at the production, auction market and packing plant levels. The use of age verification helps ensure that consumers keep buying beef and that helps to maintain the market for weaned calves.

# Summary

An understanding of the cow's reproductive cycle and brood cow management is necessary for the maintenance of reproductive efficiency for a profitable beef operation. Providing adequate nutrition for production and reproduction, shortening the breeding season, pregnancy testing and culling open cows, and developing well-grown replacements all contribute to an efficient, profitable beef herd. Selecting and caring for your herd bulls are essential aspects for maintaining herd reproductive efficiency. The goal of every beef cow operation should be the production of a live healthy calf from each cow in the herd at a yearly interval.

Brood cow management is a key element in a successful cow-calf operation. Body condition scoring can be a useful tool in improving cow reproductive performance, in developing cost-effective feeding strategies and in detecting possible health problems. At the start of the winter feeding program the optimum body condition score is 3.0. At calving the optimum score is 2.5 for mature cows and 3.0 for first-calf heifers. At 30 days before the start of the breeding season, the optimum score is 2.5 for all females. If cows are either thinner or fatter than these optimums, they tend to have lower reproductive efficiencies.

Once high levels of fertility have been established in the herd through good nutrition and attention to health issues, fertility levels can be maintained by limiting the breeding season to between 42 and 63 days and by culling the cows that are open in the fall. Various software programs can help you to maintain records on the performance of individual cows and the herd as whole. This information can help you develop an effective herd management program. By identifying areas of strength and weakness within the herd, and using this information to address problems, you can improve overall productivity and profitability.

Herd managers can improve the reproductive efficiency of the beef herd by ensuring that adequate energy and protein are supplied to the beef herd. Supplying adequate energy and protein during pre- and/or post-calving improves pregnancy

rates improves first-service conception rates, and reduces the postpartum intervals in suckled postpartum beef females. Herd managers who attempt to shorten the calving season by restricting the breeding season without first providing for the other essential management factors run the risk of having to cull a high percentage of their late calving cows in the first year. This has a serious impact on the weaned calf crop and cash flow in the next year. Cows should be pregnancy tested as part of the fall operation, after the calves have been weaned and before winter feeding starts.

Producing top quality replacement heifers requires proper management of the cows from birth. Good nutrition is a key element. A benchmark for feeding replacement heifers is that a heifer should weigh 60 to 65 per cent of her mature weight by breeding time and 85 per cent at calving time. Both inadequate nutrition and overfeeding can reduce reproductive efficiencies of heifers. Ensuring adequate nutrition for first-calf heifers during lactation is especially critical. Choosing a younger, easy calving bull with sound expected progeny differences helps to reduce calving problems in first-calf heifers. Breeding heifers to calve about two to three weeks before the mature cow herd allows the heifers extra time to recover after calving so they rebreed with the main cow herd.

Bull selection depends on the type of cow to be bred and the objectives of the producer. The best bull for one herd is not necessarily a good choice for another herd. A complete assessment of potential fertility includes an evaluation of physical soundness, reproductive organs, semen quality and nutritional status. Selection of bulls with larger scrotal circumference should increase inherent fertility in both male and female progeny. Proper selection and management of the beef bull increases the probability of a successful breeding season.

Good reproductive efficiency in the beef herd, by ensuring adequate nutrition, shortening the calving season and pregnancy testing, provides important advantages. They include:

- heavier, more uniform calves at weaning
- improved use of available labour
- better opportunity to select for fertility in the cow herd
- greater income and more profit.




 Genetic

# Improvement Methods

Genetic improvement of cattle takes planning, patience, good record keeping and the ability to make some hard choices about which cattle will work best for your farm. Your neighbour's best bull may not work out at all for you unless your management and cow environment are the same. If your pasture quality or winter feeding program are substantially different and you want to put in less time pulling calves, you might be better off buying breeding stock elsewhere or developing an artificial insemination program.

This chapter discusses how to choose a breeding system, choose the animals that will work the best on your farm, buy or select replacements for your cow or bull herd and manage an artificial insemination program.

## First Steps

### Record Keeping

The first step in any genetic improvement program is to know where you are at. This involves record keeping. Are the weaning weights of your calves increasing or staying the same? Are your replacement heifers calving a bit later than they used to even though the bulls are going in at around the same time? Environmental changes such as a drought and poor-quality feed have a major effect on these traits, but with a few years of record keeping, changes due to environment are easier to sort out from changes due to genetics. Some work with a pencil and paper is required. Another option is to computerize your cow records. A number of commercially available software packages for cattle herd record keeping are evaluated at: <http://www.farmcentre.com/english/farmsoftware/cattle.htm>.

## Setting Your Objectives

Once you know where you are, it is time to plan where you would like to be. Do you want your calves to be 25 kg (50 lb.) heavier when they run through the sales ring? Perhaps you want to make them more uniform in colour or size so that they are more attractive to the buyers. Maybe you want more of your heifers weaning a calf or less open cows in general.

Some of these traits are mainly due to genetics, while others are more influenced by the environment and your management. The amount that a trait is determined by genetics is called its heritability. When planning a breeding program, traits of high (greater than 50 per cent) or moderate (30 to 50 per cent) heritability may be improved by genetics. Colour of the cattle and whether or not they are polled (no horns) or horned are highly

heritable. Traits of low (less than 30 per cent) heritability should be improved by management changes. Table 19 lists the heritability of a few of the more common traits.

To succeed with your selection objectives, it is important to go slow and make small incremental changes to those desired traits (Table 20). For example, cows that are having 35 kg (80 lb.) calves without many problems can probably handle 40 kg (90 lb.) calves. A new bull that sires 55 kg (120 lb.) calves may cause management problems such as increased dystocia and prolonged return to estrus.

## Breeding Principles

A sound breeding program based on genetic selection depends on the following factors:

**Number of traits selected** – The more traits selected, the slower the progress made for any one of them. However, the cumulative advantage of selecting for several traits at once may be greater than the single advantage of selecting for only one. Geneticists have developed selection indexes that can evaluate a number of economically important traits in animals at the same time. If animals are selected under conditions similar to that of your farm, you have a better chance that they will work well for you.

**Generation internal** – This is the length of time it takes to turn over the breeding herd of both bulls and cows. The faster both cows and bulls are replaced by superior animals, the more rapid the

TABLE 19. Heritability of some traits

Trait	Heritability (%)
Calving interval (fertility)	10
Birth weight	40
Weaning weight	30
Cow maternal ability	40
Cow milking ability	30
Feedlot gain	45
Pasture gain	30
Efficiency of gain	40
Final weight	60
Muscling	50

TABLE 20. Be careful with your selection goals

Desirable trait	Trait(s) that you may also get
Improved carcass muscling	Slower growth rate
Higher calf weaning weight	Greater cow feed requirement, increased cow milk production
Increased rate of gain on feed	Increased calving difficulty, increased cow size, reduced compatibility of cow to environment, lowered cow reproductive performance
Increased milk production	Increased feed requirements or reduced fertility
Ability to get by on poorer feed, "drought-proof" animals	Slower calf growth rate, increased age before puberty in heifers, reduced cow fertility

genetic improvement will be. Rapid improvement requires culling a high percentage of poor producing cows each year and using an individual bull for only one or two years. Remember, if you are making genetic progress the younger animals in your herd should be better than the older ones.

**Accuracy of selection** – If progress is to be made, both bulls and cows must be replaced by genetically superior animals in the traits selected. Using progeny-tested animals provides more accurate selection than using unproven animals. If a producer selects for weaning weight in the cow herd, but then buys unknown or untested bulls, it is most likely that only a little progress in weaning weight will result. Expected progeny differences (EPD) can now be used to estimate the amount of genetic progress possible (see the *Expected Progeny Differences* section for more information).

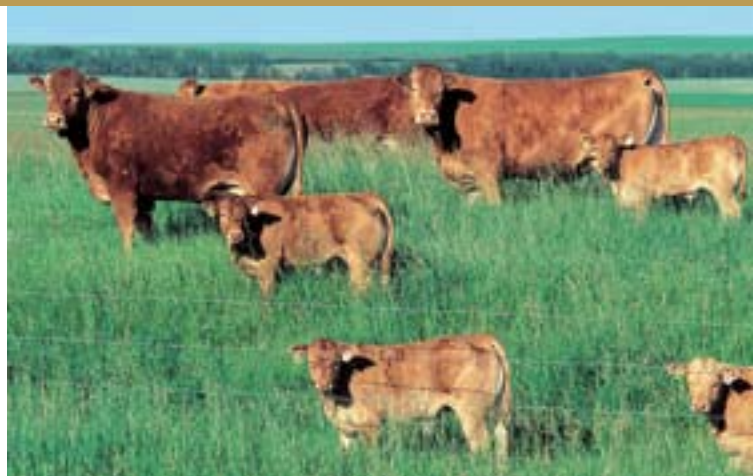
**Heritability** - As noted, heritability is the proportion of the physical variation for any trait that is attributable to the genetic make up of the animal. The more heritable the trait, the more rapid the change through selection can be.

## Breeding Systems

There are many types of breeding systems and variations within each type. This manual discusses straight breeding and crossbreeding systems and their advantages and disadvantages. Any of these systems can achieve some measure of improvement over no system at all. No one system works best for everyone. The most consistent progress is made if the breeding results are monitored. The best monitoring system is a performance test program. It should be used to cull poor cattle, to select replacements and to buy replacement sires.

### Straight Breeding

Straight breeding involves breeding cattle of only one breed. The purebred industry uses this system to maintain breed purity. It involves breeding cows to bulls of the same breed and selecting for performance, type, pedigree or combinations of all three.



*Purebred breeders use straight breeding to maintain breed purity.*

Three main variations of straight breeding are used: inbreeding, line breeding and outbreeding. A cattle producer may use variations of all three of these systems at one time in a herd.

### Inbreeding

The theory behind inbreeding is attractive. Related animals with excellent or desirable characteristics are mated in an attempt to produce a uniform group of animals, all with the same desirable characteristics. In practice, extreme care must be used as close inbreeding (sire x daughter, dam x son, brother x sister) can have disastrous consequences. On the other hand, selection is a form of mild inbreeding. Cows that wean calves with better than average weaning weights in your herd will be more closely related than average for your herd.

Generally, matings between animals more closely related than sharing one grandparent should be avoided. If animals that are too closely related are mated, fertility is the first trait to be damaged. With increased inbreeding, the herd's health and overall productivity will also decline. Good records are needed to notice the slow decreases in fertility and traits like calf survival that come with increased inbreeding.

Once popular, inbreeding is used less today. All genes come in pairs. If each gene pair can be made identical (i.e. homozygous) and favourable, it should be possible to produce better offspring. Unfortunately, undesirable genes are also "fixed" in the homozygous state by inbreeding and cause a decline in the vigour of the offspring. Culling of poor animals must be severe if real gain is to be achieved. Most producers find the culling rate too expensive.



As inbreeding increases, the health and vigour of the herd decline and productivity of the remaining cattle is lower. Be certain that the increased purity of the breeding herd is worth the cost.

## Line Breeding

This is a mild form of inbreeding. Instead of mating close relatives, progeny of a beloved parent are selected for use in the breeding herd.

Line breeding can be achieved by using the semen from a particular bull for a long period of time to increase the number of that bull's progeny in the herd. After the bull is no longer used, one or more of his male progeny become herd sires.

Obviously, the longer a sire is used the higher the level of inbreeding. Even if you believe "Fluffy 22F" to be the best bull ever born, younger animals in your herd should be better than Fluffy if your breeding program is making progress. If younger animals do not have the same performance as older animals, too much inbreeding (too much Fluffy?) may be present.

Most practitioners of line breeding remove a sire when sire-daughter matings cannot be avoided. At that point, the bull is replaced by a son. It is important to select replacements carefully in this type of program, as inbreeding will turn up duds as well as superior offspring.

Line breeding eventually stops producing superior offspring when the level of inbreeding becomes too high in the herd. At that point new genetic material should be introduced.

*Crossbreeding improves hybrid vigour.*



## Outbreeding

This involves mating animals that are largely unrelated. The main principle is to breed the best stock available. The progeny will show a certain amount of heterosis (increased size, yield and performance), also known as hybrid vigour. The expanded gene pool available in outbreeding also increases the rate of progress in selection programs.

## Crossbreeding

Research studies have shown the advantages of crossbreeding. Many crossbreeding systems have been devised to try to take full advantage of heterosis (hybrid vigour). The three main types of crossbreeding are: specific breed crosses, rotational crosses and composite or synthetic breed development.

The maximum potential hybrid vigour is obtained when a hybrid female is mated to an outcross sire, or a sire of a different breed. The more unrelated the parents, the greater the heterosis.

Heterosis is the phenomenon of a superior level of performance for certain traits attained by crossbred individuals over and above the average performance of their parents. Heterosis is measured experimentally as the difference in performance of crossbred animals from the average performance of straightbred animals of the breeds involved in the cross. This difference is usually expressed as a percentage of the average performance of the straightbreds. It is calculated by using the following formula:

$$\% \text{ Heterosis} = \frac{\text{Crossbred average} - \text{Straightbred average} \times 100}{\text{Straightbred average}}$$

This is the per cent improvement in a trait relative to the average of the parents.

For example, if the average weaning weight of the straightbred calves of breed A was 206 kg (455 lb.) and for breed B calves it was 202 kg (445 lb.), the average of the straightbreds would

be 204 kg (450 lb.). If the average weaning weight of the crossbred calves was 213 kg (470 lb.), the per cent heterosis would be estimated as:

$$\% \text{ Heterosis} = \frac{(213 - 204)}{204} \times 100 = 4.5\%$$

The improvement that one can expect in beef cattle from crossbreeding has been examined in studies reported by Dr. L. J. Sumption (1977). He noted the following effects of crossbreeding on performance within the British breeds.

The comparison of performance of crossbred and straightline bred calves produced by straightbred cows showed:

- three per cent more crossbred calves survived to weaning
- five per cent greater weaning weight in crossbred calves
- six per cent greater yearling weight in crossbred steers
- eight per cent greater yearling weight in crossbred heifers
- 10 per cent of crossbred heifers were younger than straightbreds when they showed their first heat cycle

The comparison of performance of crossbred and straightbred cows producing crossbred calves showed:

- crossbred cows had a 10 per cent higher conception rate to first service
- crossbred cows had a six per cent higher pregnancy rate at the end of the breeding season
- crossbred cows had seven per cent more calves at weaning
- crossbred cows produced six per cent more weaned weight per calf
- crossbred cows produced 15 per cent more pounds of calf weaned per cow bred

The effects of crossbreeding are increased calf survival, higher fertility, earlier maturity and faster growth rates. The three-way cross had a better level of performance than the two-way cross.

Crossbreeding requires changes in management, some of which may be regarded as disadvantageous. Some of these changes are:

- Most systems require the use of two or three breeding pastures, or the use of an artificial insemination (AI) program. Multiple breeding pastures should be considered when the herd is large enough to use a number of bulls. Crossbreeding can be adopted in small herds by using AI and a clean-up bull from a different breed (see the *Artificial Insemination* section for more information).
- Heavier milking crossbred cows, particularly first-calf heifers, require a higher level of feed and management to prevent mastitis than do light milking cows.
- Some crosses require different post-weaning management. The crossbred steers of some of the larger breeds should go straight to the feedlot and be moved to a high-energy ration without a “growing out” period. Crossbred heifers from the larger breeds should be fed to be 34 kg (75 lb.) heavier at the time of first breeding than British breed heifers.
- More effective marketing may be required, particularly when selling feeder cattle.

## Specific Breed Crossing

Specific breed systems use a single cross of specific breeds with maternal traits (e.g. milking) to produce hybrid females as brood cows for the herd. Terminal crossing is one type of specific breed system. Rotational crossing systems are included with specific breed crosses, although rotational systems are not restricted to always dealing with the same breeds as new breeds can be added if they have traits that are wanted.



Crossbred calves result from a terminal cross.

## TERMINAL CROSSING

Terminal crossing produces calves that are for selling to slaughter. In this system, the hybrid females are bred to terminal meat trait sires. Heifers from the terminal cross sires are not suitable as mother cows due to their large mature size or excessive muscling. Thus, they should be sold to slaughter. Unless you are seeking to increase your feed bill by increasing the frame size of your cow herd, do not keep terminal cross heifers as replacements, no matter how attractive they may appear.

The major problem with the terminal cross system is maintaining a female breeding herd. Producers have the option of buying all their breeding stock (which can be risky) or raising their own in separate herds. If they raise their own female replacements, they need to devote about a half of the total herd to this aspect of the enterprise. If they wish to also raise the meat sires, a further 10 percent of the cow herd has to be devoted to this cause. Just 40 per cent of the herd will be left for the terminal cross. Only large herds can try such a system because so many breeding pastures are needed, unless a full AI program is used.

## ROTATIONAL CROSSING

### Two-way rotation

A two-way rotation (Figure 15) involves two sire breeds (e.g. Hereford and Angus). The crossbred heifers are kept and bred to the other sire breed (i.e. the breed other than the one to which their own sire belongs).

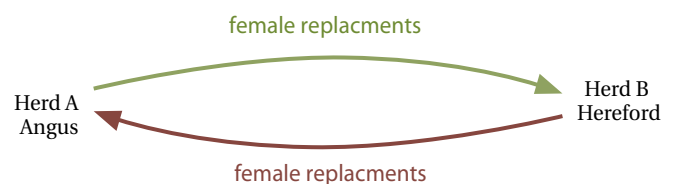


FIGURE 15. Two-way rotation

This system requires only two breeding pastures and uses hybrid females in all cases. It is capable of utilizing about 66 per cent of the total possible heterosis.

Selection of breeds is a little more complex than in the other types of specific breed systems because each breed is both maternal and terminal. The best choice is breeds that have superior milking ability.

This system works best in herds using two to four bulls. One-bull herds may use a variation of this system by using a bull of one breed for three years and then a bull of the other breed for three years. Heterosis is not high, but it is present.

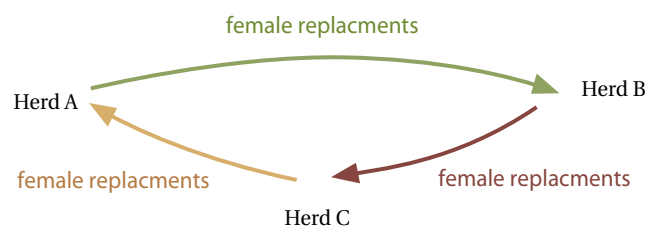


FIGURE 16. Three-way rotation

### Three-way rotation

With a three-way rotation (Figure 16), three breeding groups are required. Up to 87 per cent of total heterosis can be obtained. This system takes the greatest advantage of heterosis. Its main disadvantage is breed selection. Breed types that are strictly maternal or terminal are not likely the best choice because all breeds will be used as a source of both maternal and terminal traits. A three-way crossing system requires three to six bulls.

### Over-three-breed rotation

Rotation systems using more than three breeds do not gain much in heterosis and only increase the complexity of the breeding system. If you wish to use several breeds, try a composite or a rotational composite.

### Rotation-terminal

The major disadvantage of the three way terminal crossing system, having about 50 per cent of the females as straightbred, can be removed using this system.

Allocate about 40 to 50 per cent of the breeding females to a two way rotation system. Select the best maternal type cows for this group. The purpose of this sub-herd is to get productive female replacements. Select bulls of breeds noted for maternal characteristics, while being compatible with the overall objective of meat production, for this sub-herd.

The balance of the breeding herd is used with terminal sires. Replacements for the terminal herd come from the older or less productive, but still useful cows in the rotation group. The bulls can be selected from a meat type breed. Use a breed that blends with the cow herd and produces beef that meets market demands.

### OTHER CROSSBREEDING SYSTEMS

There are many other systems of crossbreeding for large breeding herds. They will not be discussed here. In most cases these programs usually need to be tailored for the specific herd and management conditions.

## Composites

Composites, synthetics or hybrids are terms used somewhat interchangeably to refer to new breeds or new lines of breeding. Two or more breeds are crossed with the intention of obtaining a group of traits not found in any one breed. The breeding program should select for reproduction, growth and carcass traits so that the cattle fit the most economical production and marketing environments.

What distinguishes composites from typical crossbreds is not their specific genetic make-up, but rather the way in which they are used. Composites are expected to be bred to another composite, retaining a level of hybrid vigour that we normally associate with traditional crossbreeding systems, but without further crossbreeding with outside breeds. One example of a composite would be if the farmer used a black baldy cow. She is a hybrid, the result of crossing an Angus bull to a Hereford cow. If her owner decides to breed her to black baldy sires, saving daughters and perhaps even sons as replacements, we would have to consider her a composite. She became a composite because the breeder chose to mate her to her own hybrid kind with the expectation of retaining a degree of hybrid vigour without further crossbreeding.

One of the breeding herds at the University of Alberta ranch at Kinsella is a composite of Charolais, Angus and Galloway, which had some Brown Swiss and Simmental added several years after the initial cross. The main composite herd has been consistently superior to the purebred herd that is maintained on the same premises after 20 years of breeding and selecting.

The most difficult job with a composite herd is marketing. The colour patterns can be extremely varied. If the selection program is good, all the cattle will have a good growth rate regardless of what colour they are. However, it can be difficult to persuade buyers of this unless they are crossbred enthusiasts.

The United States Meat Animal Research Center at Clay Center, Nebraska has shown that a mix of eight breeds in one breeding herd can maintain approximately 85 per cent heterosis while



the herd remains closed (i.e. sires and replacement heifers are selected from within the herd). New blood should be introduced every few years to offset inbreeding, but in larger herds heterosis remains relatively high.

It is important to differentiate between composite developers (breeders) and composite users (commercial producers). Developing a composite herd requires a large population of females and males (sires) (25 to 35 sires per generation of 500 to 700 cows). It takes time to make the initial crosses, get through several generations of within-herd matings of the crosses and liquidate the original parent stock. Performance criteria should be the main focus for selection and a consistent product should be produced. Some people have tried to stabilize colour patterns, but selection for colour reduced performance progress. Although colour varies a great deal, other economically important traits will score high for consistency, such as: fertility, survivability, growth rate, milk production, carcass characteristics and so on. The process of developing a composite herd represents a sizable investment of money, time and patience. As well, there is no guarantee that the composite will be acceptable to the industry.

Before starting to develop a composite herd, remember that every breed included in the system must bring favourable attributes to the mix. For example, one plan would be to develop a maternal composite herd of females to breed to terminal sires. In a maternal composite herd, a combination using the British breeds (Hereford, Shorthorn and Angus) and some of the dual-purpose European breeds (Simmental, Limousin and Salers) would be good choices. Many other breeds are also suitable. First choices will depend on available breeding stock and personal preferences.

Starting a composite herd or breed is difficult. If the herd is large, select several sires from the breeds you wish to include and breed a number of females to each sire. As heifers are selected from these matings, replace the original females. After a few years of preparatory breeding with outside sires, the herd is closed and both sires and dams are selected from within the herd.

Composite users have a much easier time because they are simply selecting bulls for their commercial operations just as they always have. From a management standpoint, breeding composites is like breeding straightbreds – only one breeding pasture is needed (two if heifers are bred separately). Composites can be used successfully in small herds, even in herds with only one sire. Composite users produce their own female replacements and they have the potential to produce their own replacement males. However, for most commercial users the extra level of management and record keeping required to do a good job of home-raised bull selection is probably impractical. That's why most composite bulls are purchased from composite seedstock producers.

## Evaluating Individual Animals for Breeding Performance

Selecting replacement cows and bulls is a key part of a genetic improvement program. Performance testing is an important tool for culling and selecting replacements (see the *Herd Management* chapter for more information on tracking the performance of individual animals). No matter which breeds or breeding systems are used, select only genetically superior females for herd replacements.

Choosing the right bull(s) for your breeding program requires plenty of thought and planning as half the genetics of next year's calf crop is resting on your decision. By just looking at a bull in a sale it is impossible to tell if he grew rapidly due to excellent genetics or because his owner tied a bucket full of grain and protein supplement around his neck almost from birth. Maybe both the animal's genetics and environment were excellent. Luckily, information such as expected progeny differences (EPD) can help to separate the wheat from the chaff in the bull sale ring.



## Expected Progeny Differences (EPD)

EPD values are an effective way to compare the genetic merit of individual animals. EPD values for bulls and cows are available in catalogues published by the breed associations.

### Comparing Within a Breed

You can use EPD values to predict the performance of offspring of bulls (or heifers) within a breed, even though the animals were raised on farms in different parts of the province (or country). For example, Table 21 lists a number of EPD for two bulls.

TABLE 21. Using expected progeny differences to compare two bulls of the same breed

Bull identification	Expected progeny differences (EPD)			
	Birth weight (lb.)	Weaning weight (lb.)	Yearling weight (lb.)	Scrotal circumference (cm)
Newbie 7M	-2	+5	+4	+2
Fluffy 22F	+5	+12	+20	-2
Difference	7	7	16	4

EPD numbers are always listed in the units of the traits in question. Comparing the two bulls, calves sired by Newbie 7M will be 7 lb. lighter at birth and at weaning than those sired by Fluffy 22F. Yearling weight of Fluffy-sired calves will be 16 lb. higher, although scrotal circumference of a Newbie-sired calf will be 4 cm larger than a son of Fluffy. Unless your own herd sires were part of the same EPD evaluation, you do not know how Newbie and Fluffy compare to the bulls you already have. As well, using Fluffy 22F does not mean that the weaning weight of your calves will increase by 12 lb. unless your other herd sires have an EPD of 0 for weaning weight. Additionally, an EPD of 0 does not mean an animal is breed average for that trait. After years of selection for performance traits, some breeds have EPD with averages far from 0.

In addition to the EPD number, the breeding associations provide accuracy values ranging from 0 to 1 in the EPD catalogue. The accuracy value is a reflection of how much information from progeny and other relatives went into the EPD calculation. EPD values with high accuracy (0.8 or higher) are less likely to change with the addition of more information and are an excellent estimate of the true genetic merit of an animal for the trait(s) in question. Sire summaries from the breed

associations may include both older sires (with lots of progeny information) and younger sires (with EPD of lower accuracy).

### Comparing Animals Across Breeds

If you are shopping for bulls of more than one breed, it is important to realize that EPD are not directly comparable across breeds without adjustment. Researchers in the United States have recently developed some adjustment factors for estimating across-breed EPD, which are shown in Table 22.

For example, if you were shopping for both Charolais and Simmental bulls and you had a Charolais bull with a birth weight EPD of -1 and a Simmental bull with an EPD for birth weight of +4, which bull would likely cause you the most calving difficulty at home?

To figure this out, take the Charolais birth weight EPD and add the adjustment factor:  $(-1 + 10.5) = 9.5$ . Do the same for the Simmental bull:  $(4 + 6.8) = 10.8$ . Comparing the two bulls with adjustment factors, their predicted calving difficulty based on birth weight will be about the same.

TABLE 22. Adjustment factors for estimation of across-breed EPD

Breed	Birth weight	Weaning weight	Yearling weight	Milk
Angus	0.0	0.0	0.0	0.0
Charolais	10.5	37.7	50.8	6.0
Gelbvieh	5.8	8.1	-19.9	13.1
Hereford	3.6	0.4	-8.8	-14.4
Limousin	5.9	22.1	16.2	-1.0
Red Angus	3.3	-4.0	-5.7	Not available
Salers	5.1	26.9	35.1	12.4
Shorthorn	7.4	28.0	39.1	13.1
Simmental	6.8	20.7	18.1	13.2

Adapted from: Van Vleck and Cundiff (2001)

When comparing a Limousin and a Gelbvieh bull for weaning weight, if the Limousin had an EPD of +8 and the Gelbvieh had an EPD of +22, who would have the heaviest calves at weaning? The results are: Limousin (+8 + 22.1) = 30.1; Gelbvieh (+22 + 8.1) = 30.1.

Keep in mind that adjustment factors for EPD values are estimates of an estimate – a potentially useful tool, but not something you should bet the farm on.

## Artificial Insemination (AI)

Although artificial insemination (AI) service has been available to dairy producers in Canada for over 50 years, adoption of the technology by the beef industry has been slow. While over 70 per cent of Canadian dairy cattle are bred using AI, only a relatively small proportion of beef cattle are bred this way. Recent developments in AI include the use of estrous synchronization protocols and newer methods that allow for insemination without estrous detection. These developments make AI more practical for beef herds, while offering a means of increasing productivity through a wider genetic pool.

## Advantages and Disadvantages of AI Breeding Programs

The advantages to using AI include:

- an opportunity to use bulls of superior genetics
- the option of advancing genetics at a faster pace
- the choice of using one sire on hundreds of cows to produce a more uniform calf crop
- limited risk associated with handling aggressive live bulls
- minimal threat of venereal disease
- a reduction in delayed conception caused by infertile sires
- lower breeding costs as it is generally less expensive to use AI than to purchase and maintain bulls of superior genetics
- improved cow herd records that allow for better evaluation of performance and a prediction of calving dates
- better control of conception dates through the use of a tightly controlled AI breeding season, followed by natural service using clean-up bulls

The disadvantages to using AI are:

- superior management skills are required
- more time and skill are needed, especially in the initial phases of the program
- accurate record keeping and cow identification methods are required
- additional investment is required for the construction of strong and secure handling facilities
- additional funds are needed for well-trained and motivated technicians
- more dedicated time and labour are needed for heat detection

## Managing Your AI Program

The success of an AI program requires top-level management with utmost dedication. There are many decisions to be made regarding feeding, facilities, heat detection and sire selection. Therefore, the manager needs to possess a good understanding of the estrous cycle, signs of estrous behaviour, semen storage, semen handling procedures and insemination techniques. The manager must also be familiar with the breeding herd, know the location and identification of the cows and have quick access to breeding records.

### Identification and Record Keeping

Individual identification of all cows in the herd is essential. Ear tags are the most popular identification method and several kinds of tags are available. Neck chain numbers and branding are other means of identification. No matter which method is used, the numbers should be readable from a distance and no number should be duplicated. This allows for easy identification during heat detection.

Accurate records are especially important in an AI program. Keep records of calving dates, as well as dates and times of estrus and breeding for all cows in the herd. Using a pocket record book,

transfer the pertinent information to the herd's permanent records. These records can be used later to evaluate the results of the AI program. Good communication between the herds person and the herd manager is extremely important for the success of an AI program.

## Estrous Cycle

In the cow, the estrous cycle lasts 18 to 21 days. An open cow continues to start new reproductive cycles until she becomes pregnant. Conception rates can be greatly increased if the herds person and heat detection personnel understand and chart the events that occur during the estrous cycle for each cow in the herd.

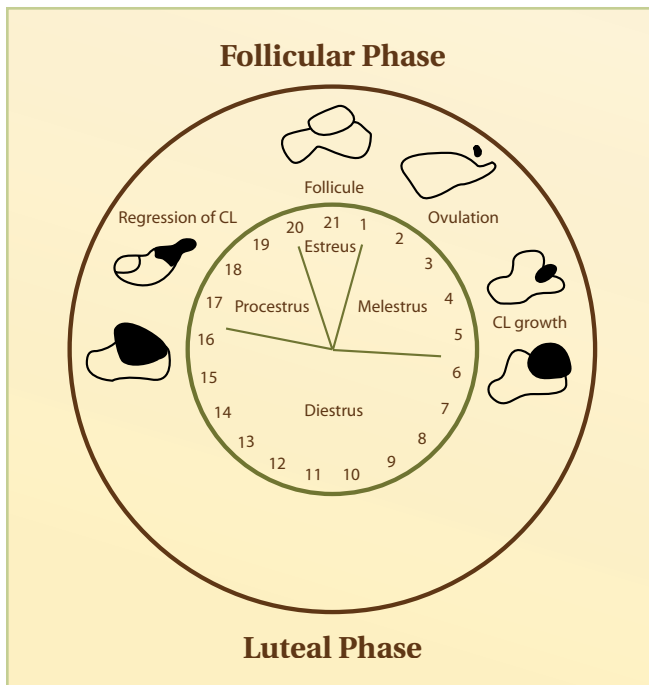
The estrous cycle is divided into four stages: proestrus, estrus, metestrus and diestrus. Proestrus and estrus make up the follicular phase of the estrous cycle. Metestrus and diestrus make up the luteal phase. Figure 17 shows the cycle in an easy-to-follow circular pattern. The first day a cow is in heat is called Day 0 of the cycle.

### FOLLICULAR PHASE

- **Proestrus** is the stage when the corpus luteum regresses, progesterone concentrations decline, a large follicle is present and estrogen secretion by follicular cells begins to increase.
- **Estrus** is the period of sexual receptivity. The behavioural changes of estrus are stimulated by a combination of low levels of progesterone and high levels of estrogens.

### LUTEAL PHASE

- **Metestrus** is the transition phase. During this stage ovulation happens and the corpus luteum forms and begins to produce progesterone.
- **Diestrus** is the quiet phase. During this stage the corpus luteum is functional and progesterone levels are high.



**FIGURE 17.** Phases of the estrous cycle

### VISIBLE SIGNS OF ESTRUS

Estrus is defined as that point in the cow’s estrous cycle when she is receptive to be bred and the chance for conception is at its highest. The estrous stage has three substages: pre-standing heat (early estrus), standing heat (estrus) and post-standing heat (late estrus). A cow that is in heat or coming into heat is often restless and may be seen walking the fence line or heard bawling. Sniffing, licking and head butting of herdmates are also typical signs of early estrus. The surest sign of estrus is when a cow stands to be ridden by a bull, another cow or a steer (standing heat). Table 23 lists the visible signs that can assist the herdsman in determining if estrus is present.

### Estrous Detection

The detection of estrus (standing heat) requires considerable effort and time, but it is extremely important to a successful AI breeding program. To master the skill of heat detection, the manager must not only be familiar with the animals in the herd, but must also understand the behavioural signs that a cow exhibits before, during and after standing heat. Most estrous activity can be detected early in the morning (around dawn) and later in the day (around dusk).

For the best results, heat detection must be performed three to four times daily for 20 to 30 minutes each period. Where such frequent observation is not possible, at least twice daily observation, preferably at dawn and dusk, for 30 minutes each time is essential. The person performing heat detection must be fully dedicated to this task.

### TIPS FOR ENSURING PROPER HEAT DETECTION

These include:

- assign one person to be responsible for heat detection
- identify each animal properly
- know the signs of heat
- record cow activity, signs and heat dates on a calendar
- do not schedule heat detection during feeding time
- allow for cattle to have adequate exercise and proper footing to ensure safe mounting

**TABLE 23.** Signs of estrus

Pre-standing heat	Standing heat	Post-standing heat
<ul style="list-style-type: none"> <li>• attempts to mount herdmates</li> <li>• will not stand to be mounted</li> <li>• restless, sniffing, licking and head butting of herdmates</li> <li>• bellows</li> <li>• clear mucous discharge from the vulva</li> </ul>	<ul style="list-style-type: none"> <li>• stands to be mounted</li> <li>• bellows</li> <li>• exhibits nervous behaviour</li> <li>• more cohesive discharge from the vulva</li> </ul>	<ul style="list-style-type: none"> <li>• dirty flank</li> <li>• rough filled tail head</li> <li>• sweats</li> <li>• bloody discharge from the vulva</li> </ul>



## ESTROUS DETECTION AIDS

Several devices are available to assist with estrous detection (Figure 18). Most of these aids are attached to the cows being observed for estrus. Others are attached to heat detector animals, such as gomer bulls, androgenized females or steers. Gomer bulls have been surgically altered by vasectomy, penectomy or surgical deviation of the penis (the insertion of a peno-block in the sheath to prevent mating). Androgenized cows have been treated with male sex hormones to make them behave like bulls in the presence of cows in heat.

The simplest and least expensive aids for estrous detection are tail chalk, tail paint and other such marking devices. These agents are used to colour the tail head region of cows. It is important to make the markings conspicuous – 5 to 8 cm (2 to 3 in.) wide and 15 to 23 cm (6 to 9 in.) long. It is recommended that the hair coat is combed and pushed forward during application. When mounting activity occurs the hair gets ruffled and pulled back, providing an indirect indicator of mounting activity if the colour from the marker device happens to become less conspicuous. Wet weather conditions will reduce the effectiveness of this method of estrous detection.

Pressure-sensitive devices such as the Kamar Heatmount Detector™ (Kamar Inc.) may be glued to the tail head area of the cow. When the cow comes in heat and is mounted by a heat detector animal or herd mate, the detector changes colour from white to red (Figure 18). Another device that uses a similar technology is the Bovine Beacon™ (Omniglow Corp.). Upon being activated by the pressure of a mount, the Bovine Beacon™ changes colour and glows in the dark. This makes it easier to identify cows in estrus during the night.

*Non-activated Kamar marker  
– cow is not in heat*



*Activated Kamar marker  
– cow is in heat*



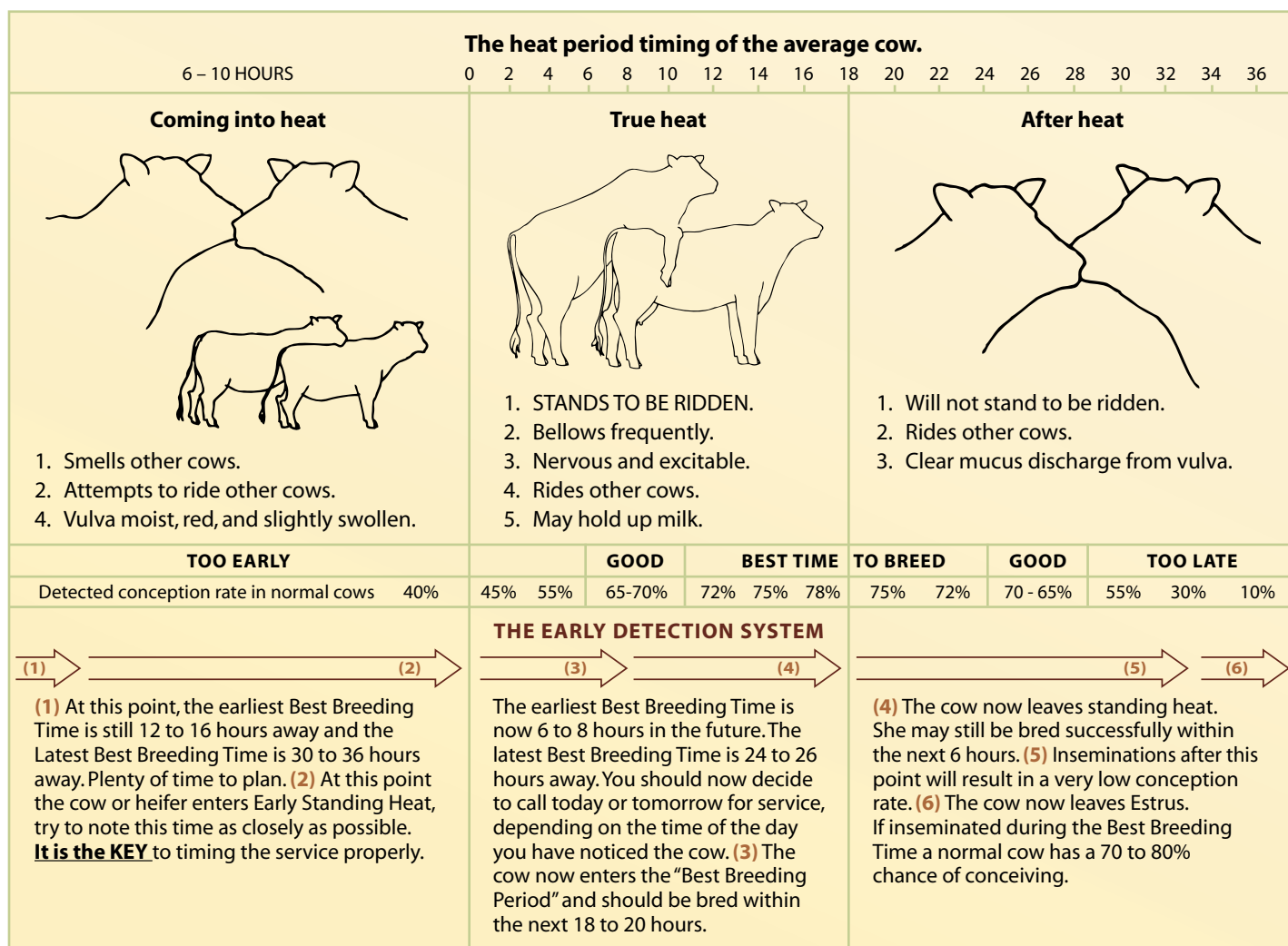
**FIGURE 18.** Kamar marker for estrous detection

Pressure-sensitive electronic devices are also available as estrous detection aids. MountCount™ is one such device marketed by DDX Inc. This battery-powered device is applied to the tail head region of a cow. When the cow is mounted, the pressure switch of the MountCount™ device is activated and the heat status of the animal (e.g. suspect heat, standing heat or optimal breeding time) is indicated through a series of three light-emitting diodes on the back of the unit. All of these devices should be used with caution as pressure from sources other than a mounting animal may also trigger the devices.

The HeatWatch™ system is a fully electronic system that is available for heat detection. DDX Inc. also markets it. This system includes a pressure-sensitive device that is glued on to the tail head of the cow. Upon activation by a mount lasting a minimum of two seconds, a built-in transmitter sends a radio signal. An antenna that is usually located within 400 m (1,310 ft.) of the sensor is used to receive the signal. The information is also sent to a buffer storage system, eventually connected to a computer. The signal carries information such as sensor (cow) identification, date, time and duration of sensor activation. Periodically, the herds person can log onto the computer to generate a report about cows in suspect or standing estrus.

Other electronic heat detection systems identify animals in estrus based on their increased activity, which is a sign of estrus. CowTrakker™ (Boumatic) is another system featuring an electronic ID and estrous detection tag that is worn around the neck. This is a relatively new introduction. It is primarily for dairy cattle and its effectiveness is not known at this time. There are other electronic products on the market, mostly developed for use with dairy cattle.

Another heat detection method involves the use of heat detector animals fitted with chin ball markers. Gomer bulls, androgenized cows or steers can be fitted with halters equipped with chin ball markers. The markers leave a strip of paint on the back of a cow when a marker animal mounts her.



**FIGURE 19.** Time to breed for best results

As with the other systems, this heat detection aid must be used with caution. One problem is that the marker animal may not mount all animals in heat on a particular day. A second problem is that a cow may be mounted and marked when she's not in heat, particularly if the herd is kept in close confinement.

Although heat detection aids can be very helpful, there is no substitute for visual observation by a skilled person who monitors the herd three to four times per day for estrous behaviour. Figure 19 shows the signs to watch for.

### Insemination Timing

The period of standing heat normally lasts less than 12 hours, and cows ovulate 24 to 30 hours after the onset of standing heat. After insemination, sperm can live for over 24 hours in the female tract.

In contrast, the ovum (egg) can only live for eight to 12 hours after ovulation. Thus, it is recommended that AI be timed so that sperm are readily available for fertilization when the egg is released.

Optimum conception rates occur when semen is deposited in the female tract about six to eight hours before ovulation. However, satisfactory conception rates are achievable when insemination occurs anytime from the onset of standing heat up to 24 hours later. Therefore, for convenience of management, all inseminations can be routinely completed using the AM - PM rule. That rule is:

- Those cattle seen in standing heat during a.m. time (dawn to noon) will be bred in the p.m. (afternoon) on that day.
- Those cattle seen in standing heat during the p.m. will be bred during the a.m. of the next day.

If you are in doubt about the time of onset of estrus, breed as soon as the cow is seen in estrus. Figure 19 illustrates the indications of heat and when a cow should be bred for the best results.

## Factors Affecting Cow Fertility

Cow fertility, an often-underestimated issue in a normal breeding program, becomes particularly important in an AI program, as other methods of heat detection are used instead of bulls. Cow fertility has become a major concern and more evident with the increased use of AI records.

Using breeding records allows managers to more easily identify those animals with breeding problems and/or low fertility. Cow fertility can be measured by analyzing the following records: the number of services per conception, the number of days from calving to first heat, breeding season length, pregnancy rate or per cent of open females.

Fertility is closely associated with nutrition (both before and after calving), an adequate recovery period between calving and breeding, and freedom from diseases and other abnormalities. Avoid placing your cows under stressful conditions prior to breeding and for the first 45 days after breeding. Though proper nutrition must be provided year-round, the 60 days prior to and following calving are the most critical for proper ration management.

Research has conclusively demonstrated that cows on a proper plane of nutrition both before and after calving will come into heat sooner and conceive more readily. Vitamins A, D and E, and the minerals calcium, phosphorus and selenium are essential for the reproductive function. Therefore, it is important to ensure that these nutrients are adequately fed to maintain optimum cow fertility. Crude protein intake at high levels (exceeding 18 per cent) can have a detrimental effect on reproduction. Recommended crude protein intake is 8 per cent for dry cows and 12 per cent for lactating cows. (For more information, see the *Nutrition and Feeding Management* chapter.)

## Sire Selection

One of the advantages of using AI is the opportunity it provides to select beef sires with superior genetic traits. Some of the best sires in the world are currently available through local

AI companies. The semen of top-performing, progeny-tested sires is available at a reasonable cost. You can select the kind of bull that is best for your herd.

Information on the performance of a progeny-tested bull should include data on the birth weight, weaning weight, ease of calving, post-weaning gain and yearling weight of his offspring. These data, along with fertility rating (non-return rate), should be used in selecting the sire or sires to be used in an AI breeding program. Sire selection is as important when using AI as it is with natural service. Remember that not every bull available through AI is necessarily genetically superior for the traits that you are interested in.

## Semen Quality and Handling

There are several AI companies in Alberta and they are the principal sources of semen and AI supplies. While individual breeders may offer semen for sale, it is recommended that a sample be evaluated by a veterinarian or other qualified personnel before it is used. Only top-quality semen, which has been properly handled and stored, should be used if the desired results are to be achieved.

Correct semen handling is yet another critical step in the total AI program. To ensure proper semen handling and increase conception rates within your cow herd, it is recommended that you attend an AI course or use a licensed AI technician. AI courses are available through the extension programs of agricultural colleges and through AI companies.

*Semen tank, cow in headgate and semen straw.*



Semen is stored in straws that are sealed at both ends. The straws are kept in a tank of liquid nitrogen. Make sure semen storage tanks are protected from heat, direct sunlight and violent movements. Check periodically to ensure the liquid nitrogen level in the tank is adequate. Maintain a logbook/inventory (keep it attached to the tank) to show dates of last filling, and to record addition or removal of semen straws. You must be able to locate a straw in the AI tank, remove it quickly without disturbing other straws, and thaw it correctly to ensure optimal numbers of live sperm cells, thus increasing the chances of conception.

It is also important to know those factors that reduce semen survival:

#### Temperature

- higher than 45C will kill sperm
- increased temperature exhausts sperm
- decreased temperature reduces viability

#### Sunlight

- direct sunlight is detrimental
- short exposure reduces viability
- avoid exposure to sunlight and florescent lights

#### Water

- water kills sperm

#### Impurities and bacteria

- impurities and bacteria reduce the number of sperm or kill all the sperm
  - blood and manure kill sperm
- protect semen from dust, flies and sprays

#### Disinfectants

- disinfectants kill sperm
- after using 70 per cent alcohol to clean the area around the vulva, the area must be thoroughly dried

## BRIEF SUMMARY OF SEMEN HANDLING

- Check all AI equipment and supplies several days before beginning insemination to make sure everything is in order.
- Use sanitary precautions.
- Thaw straws at 35 to 37C (95 to 98F); a temperature-controlled thawing unit (water bath) is recommended (e.g. cito thaw, 12-volt or 120-volt).
- Use thaw time of 30 seconds minimum and 15 minutes maximum for all thawing methods.
- Attempt to have AI gun at or near body temperature by warming it in your hands or placing it inside a breast pocket.
- Wear protective glasses while working with liquid nitrogen and when handling straws.

## STEPS INVOLVED IN AI

- Place straw in water bath.
- Check bull ID.
- Dry straw with clean paper towel.
- Place straw in AI gun with crimped end up (if air temperature is cold, warm AI gun by hand friction before loading straw).
- Cut crimped end of straw to open it. Use straw-cutter rather than scissors to ensure a straight cut. (If straw is cut crookedly, semen may not be fully delivered to female reproductive tract.)
- Place AI sheath over straw and AI gun, and lock sheath on AI gun. Using a sanitary sheath is also recommended.
- Protect loaded AI gun from adverse temperature to prevent temperature shock. In cold weather, wrap AI gun in clean paper towel and place it inside your coveralls or coat to warm it up.
- Proceed to confined cow, empty rectum and clean vulva.
- Insert gloved, lubricated arm into rectum; locate and grab cervix (neck of the womb).



- With free hand, place gun in vagina and gently insert forward.
- Negotiate vaginal folds, and pass AI gun through cervix.
- Deposit semen at junction of cervix and uterus.
- Withdraw gun.
- Dispose of sheath, glove and straw after recording breeding information from straw.

## Ten Point Guide to High AI Conception Rates

- Check for heat twice a day. Using heat detector animals and marker devices (such as a gomer bull with a chin ball marker) will greatly improve your rate of heat detection.
- Use a licensed AI technician, send your employee(s) for AI training or attend an AI course yourself.
- Buy semen from reputable and licensed AI businesses.
- Ensure semen storage tanks are protected from heat, direct sunlight and violent movements.
- Check periodically to ensure the liquid nitrogen level in the tank is adequate. Maintain a logbook/inventory (keep it attached to the tank) to record dates of last filling, and addition or removal of semen straws.
- Thaw the straws in warm water (35 to 37C) for 30 to 40 seconds prior to insemination.
- Avoid placing your cows under stressful conditions prior to breeding and for the first 45 days after breeding.
- Check all AI equipment prior to starting insemination procedures.
- Keep excellent breeding records.
- Cull animals with a history of breeding problems.

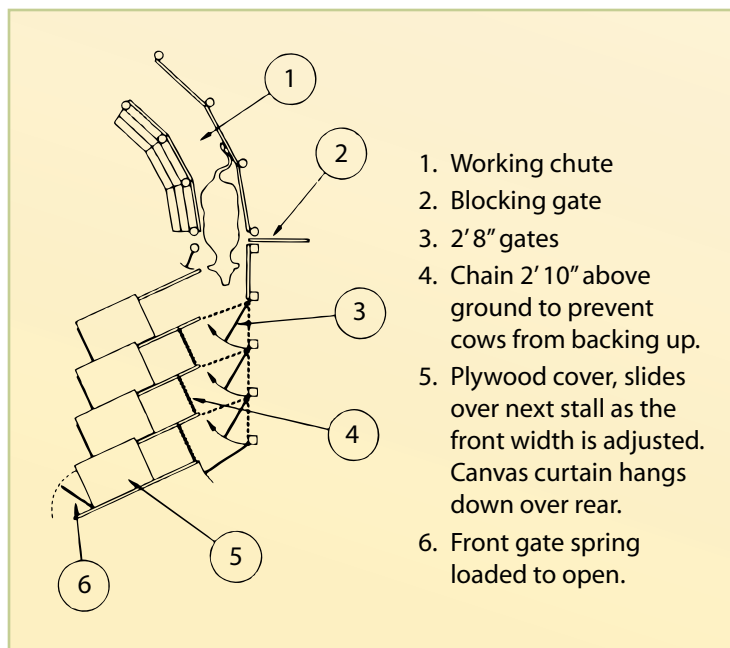
## Breeding Pasture and AI Facilities

Breeding herds should be placed in a small, level pasture that is relatively free of trees and gullies so that cows can be easily observed for heat. The pasture should supply ample feed and water for the duration of the AI program.

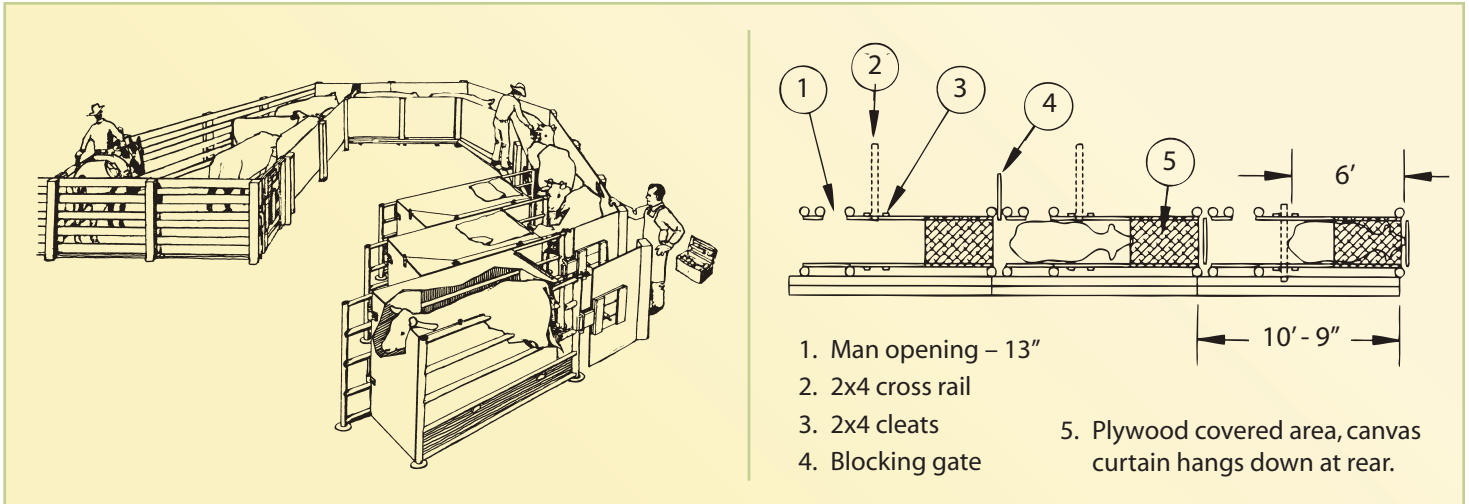
Proper handling facilities are often overlooked in an AI breeding program. A well designed cattle handling facility removes the frustration and hazards often associated with inseminating cattle.

The facilities should be built in a location that is as close as possible to the breeding pastures. When it is time to inseminate, cattle should be moved gently into a shaded area where they can be held and bred without exposure to the hot sun or rain. A roof over the chute and the breeding area provides protection from adverse conditions. Minimizing excitement and stress increases the conception rate.

Elaborate facilities are not necessary, but if a large number of cows are going to be bred year after year, a substantial investment is worthwhile. This is particularly true if estrous synchronization is used. In that situation, consider using a herringbone AI breeding chute (Figure 20), which consists of several “dark boxes” as described below.



**FIGURE 20.** Herringbone AI breeding chute system



**FIGURE 21.** Two versions of a pregnancy testing and AI chute containing a “dark box” (Herringbone and Straight Alley).

Cattle tend to follow a curved path more easily than a straight path. With a curved chute, cattle cannot see the AI chute until they are practically in it. Many cattle breeders have found that the best way to keep cattle calm during insemination is to use a dark box chute that does not have a head gate. The cow being inseminated is held in a totally enclosed dark chute. The top, side and front gate are completely solid, with the exception of a small 15 x 30 cm (6 x 12 in.) window in the front gate. The window helps entice the cow to enter the dark chute. The dark chute (Figure 21) is simple to build and can be modified to accommodate animals of various sizes. Plans for beef cattle corrals and breeding chutes are available in *Corrals for Handling Beef Cattle*, an Alberta Agriculture and Food publication.

### Controlled Breeding Programs

Controlled breeding programs enable producers to control the estrous cycle of a cow to allow AI breeding at a specific time. On a herd basis, a large percentage of the cows can be synchronized to come into heat during a short period of time. This allows them to be inseminated during a single insemination period. This procedure minimizes the need for intensive daily heat detection over the usual three- to six-week AI breeding period. It is, however, still useful to heat detect to verify that cows are coming into heat and strong standing heats are occurring.

### SYNCHRONIZATION OF ESTRUS AND AI AT DETECTED ESTRUS

Several different protocols are available for synchronization of estrus in beef cattle.

The most commonly used drug to induce and synchronize estrus in cattle is prostaglandin F2 (PG). Two common commercial PG preparations available in Canada are Estrumate® (Schering) and Lutalyse® (Pfizer).

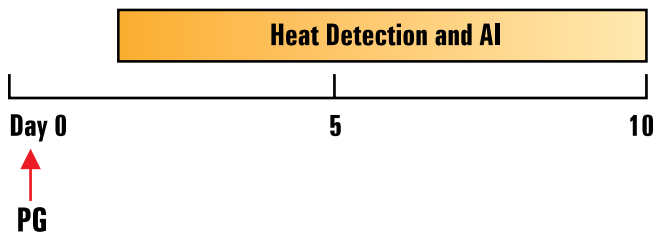
PG causes the forced regression of the corpus luteum of cattle, thereby inducing estrus. The corpus luteum, also referred to as the CL, is a temporary gland-like structure that develops on the ovary soon after ovulation. The CL secretes progesterone, a hormone essential for maintaining pregnancy. When an active CL is present on the ovary, the concentration of progesterone in the blood is high. This prevents the animal from coming into estrus. An injection of PG forcibly regresses the CL and lowers progesterone concentration, leading to estrus. The use of PG has some limitations, as it is effective only in cattle that have an active CL. Typically, a CL is non-responsive to PG during the early (Day 1 to 4) and late (Day 16 to 20) stages of the estrous cycle. Thus, PG treatment is only effective from Day 5 to 15 of the estrous cycle.

As estrous detection is easier and estrous behaviour more pronounced among a group of sexually active cattle, it is recommended that at least five cows be injected with PG at a time to enable the formation of a sexually active group.

Two different protocols are available for induction and synchronization of estrus in a group of cattle using PG alone.

**Protocol A:** For this protocol (Figure 22), inject PG any day without regard to the stage of the estrous cycle. Watch for estrus for the next seven to 10 days and breed on detected estrus.

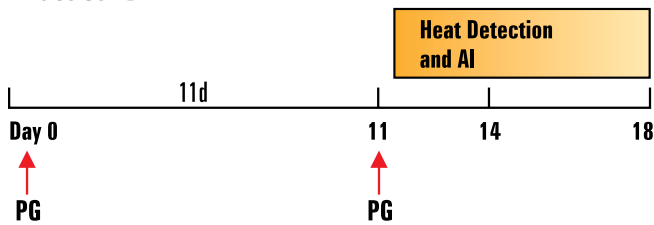
**Protocol A**



**FIGURE 22.** Protocol A for synchronization of estrus

**Protocol B:** In this protocol (Figure 23), give two injections of PG 11 days apart. Watch for estrous behaviour for seven days after the second PG injection, and breed on detected estrus.

**Protocol B**



**FIGURE 23.** Protocol B for synchronization of estrus

Protocol B helps bring a higher percentage of cattle into estrus after the second PG injection as more animals will have an active CL at the time of the second PG injection. Here is how it works.

**Example 1:** A cow on Day 2 of her cycle will not respond to the first PG, but will be on Day 13 of the

same cycle at the time of the second PG injection. She will respond to the second PG injection and come into estrus.

**Example 2:** A cow on Day 18 of her cycle also will not respond to the first PG injection, but will be on Day 8 of a new cycle at the time of the second PG injection. She will respond to the second PG injection and come into estrus.

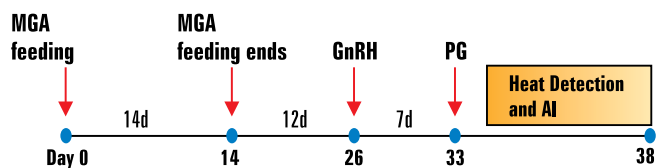
**Example 3:** A cow on Day 8 of her cycle will respond to the first PG injection, undergo CL regression, come into estrus three to four days later and start a new cycle. At the time of the second PG injection she will be seven days into her new cycle and therefore, responsive to the second PG injection.

The use of progestagens and gonadotropin releasing hormone (GnRH) in a strategic combination with prostaglandin is another way of synchronizing estrus in beef cattle. Melengestrol acetate (MGA<sup>®</sup>) is an inexpensive oral progestagen that is commercially available from Pfizer Animal Health. An intravaginal progestagen insertion device, referred to as CIDR<sup>®</sup> (controlled internal drug release), is now being marketed by Pfizer Animal Health. Some of the commercially available GnRH preparations are Cystorelin<sup>®</sup> (Merial, dose: 2 mL), Fertiline<sup>®</sup> (Vetoquinol, dose: 2 mL), Fertagyl<sup>®</sup> (Intervet, dose: 2 mL) and Factrel<sup>®</sup> (Ayerst, dose: 2 mL).

The following two protocols show how these products can be used for the synchronization of estrus in cattle.

**Protocol C:** The protocol (Figure 24) starts with 14 days of feeding MGA at 0.5 mg per head each day. Twelve days after the end of MGA feeding (Day 26) cows receive a GnRH injection. Seven days after the GnRH injection (Day 33), cows get an injection of PG, followed by a three- to five-day period of heat detection and breeding. This protocol is commonly referred to as the MGA-Select system.

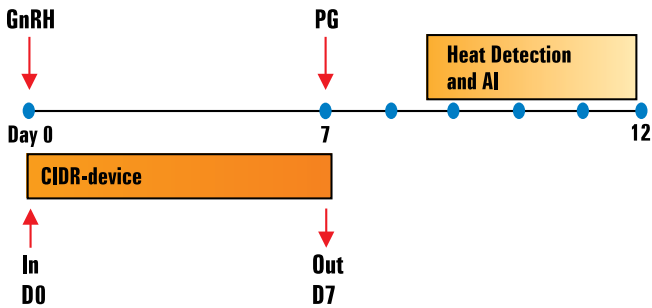
**Protocol C**



**FIGURE 24.** Protocol C for synchronization of estrus

**Protocol D:** This protocol (Figure 25) starts with the injection of a GnRH preparation and the intravaginal insertion of a CIDR® device at the same time. Seven days later, the CIDR® device is removed and a PG injection is given, followed by a three- to five-day period of heat detection and breeding.

#### Protocol D



**FIGURE 25.** Protocol D for synchronization of estrus

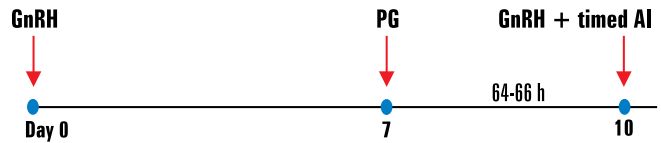
### INSEMINATION WITHOUT ESTROUS DETECTION

Recently developed protocols for synchronization of ovulation offer the convenience of inseminating cattle at a fixed time without the need for estrous detection. One protocol, referred to as Ovsynch, is becoming popular with dairy farmers. This procedure is described below (Protocol E).

**Protocol E-1:** This protocol involves a series of three injections. GnRH is first given at a random stage of the estrous cycle (to initiate the growth of a new follicle). This is followed seven days later by PG, to regress the CL. A second dose of GnRH is given two days after PG (to synchronize ovulation), and cows are inseminated about 16 hours later (i.e. 64 hours after PG). If there is a desire to reduce the number of times cattle are handled, it is acceptable to give the second GnRH injection at the time of insemination (Protocol E-2).

**Protocol E-2:** This protocol (Figure 26) is GnRH on Day 0, PG on Day 7, GnRH + AI on Day 10, about 64 hours after PG.

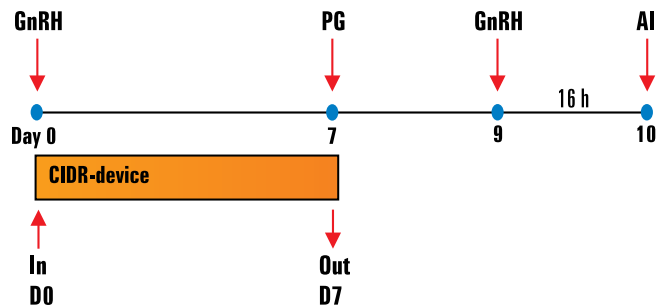
#### Protocol E-2



**FIGURE 26.** Protocol E-2 for synchronization of estrus

**Protocol F:** This protocol (Figure 27) is similar to Protocol E, but has an added component of inserting a CIDR® device at the time of the first GnRH injection and removing the CIDR® device at the time of the PG injection. As described before, if so desired the second GnRH may be injected at AI, approximately 64 hours after PG.

#### Protocol F



**FIGURE 27.** Protocol F for synchronization of estrus

Although Protocols E and F offer the convenience of not having to watch for estrus, conception rates for these two protocols tend to be lower than those following AI at detected estrus. Typical conception rates for Protocols E and F are around 40 per cent and 55 per cent, respectively.

Conception rates for AI at detected estrus (i.e. Protocols A to D) should exceed 60 per cent in well-managed herds.



## Clean-up bulls

Two important factors for any AI breeding program are: the length of the breeding season and the use of clean-up bulls. Under most AI breeding programs, it is impractical to breed by AI alone or to expect all cows to become pregnant after their first service. The amount of feed available in the breeding pasture and the amount of labour required for heat detection often determines the length of the AI breeding program. While a four- to six-week AI breeding program was popular in the past, the trend today is for a shorter AI breeding period after synchronization of estrus. This is followed by exposure to clean-up bulls to impregnate any cows that remain open.

## Summary

Genetic improvement of cattle takes planning, patience, good record keeping, monitoring of results and making some hard choices about which cattle will work best for your farm.

Traits that are highly or moderately heritable may be improved by a breeding program. Straight breeding, crossbreeding and composite breeding are the main types of breeding systems. Within each of these systems, there are many possible variations. They all have advantages and disadvantages. Any system of breeding should be relatively simple in terms of resource and management requirements.

Genetic improvement requires performance testing of your own herd and possible replacements. Sire summaries published by breed associations offer a catalogue of EPD values and other performance information, which can be used when shopping for individual bulls or lines of cattle. Don't just fall for a pretty face. A buying decision based on performance information will put you in the fast lane to genetic improvement. If progress seems slow at first, keep at it. Your rate of progress will increase once good females begin to replace poor ones.

Artificial insemination has both advantages and disadvantages. You will need to decide whether it is the right choice for your own operation. AI requires top-level management, including good record keeping and a good understanding of the estrous cycle, signs of estrous behaviour, semen storage and handling, and insemination techniques. Various heat detection aids are available and they can be very helpful. However, there is no substitute for visual observation by a skilled person who monitors the herd three or four times a day for estrous behaviour.

Controlled breeding programs enable producers to control the estrous cycle of cows so a large percentage of the cows in a herd will come into heat during a short period of time. This procedure reduces the need for intensive daily heat detection over the AI breeding period.





## Calf Management

# from Birth to Weaning

This chapter covers calf management up to weaning time. It outlines the stages of labour and potential problems, and provides tips on assisting with calving difficulties. It describes how to look after a newborn calf and processing of the new suckling calf, including disinfecting the calf's navel, identification, castrating and dehorning. It then discusses management of the suckling calf with respect to identification, vaccination, castration, dehorning, implanting and creep feeding. Finally, it discusses weaning programs to get calves established on their own as easily and efficiently as possible, and outlines preconditioning options.

## Calving

# Management

The basis of a healthy calf is a healthy pregnancy.

## Pregnancy and Nutrition

As noted in the *Herd Management* chapter, a cow's nutrition during pregnancy has an important effect on the incidence of dystocia (calving difficulty), calf survival and the subsequent fertility of the cow. You must provide the proper nutrients in sufficient quantities for the maintenance of the cow and the growth of her unborn calf.

Depending on the cow's breed and her body condition when weaning her previous calf, the cow should gain between 45 and 90 kg (100 and 200 lb.) before her next calving date. To help cows gain body condition, wean calves one to two months earlier than you normally would. This allows cows to increase body condition before winter. This should reduce the cows' winter feed requirements and

increase the calf crop weaned in the following year. Heifers and thin cows require special attention because they are going through a period of growth themselves and require a higher level of nutrition. Consequently, they should be fed separately from the main herd.

Cows should calve with a maximum body condition score of 3 (see the *Body Condition and Reproduction* section in the *Herd Management* chapter). Avoid overfeeding pregnant cows because over-fatness at calving time can cause calving problems.

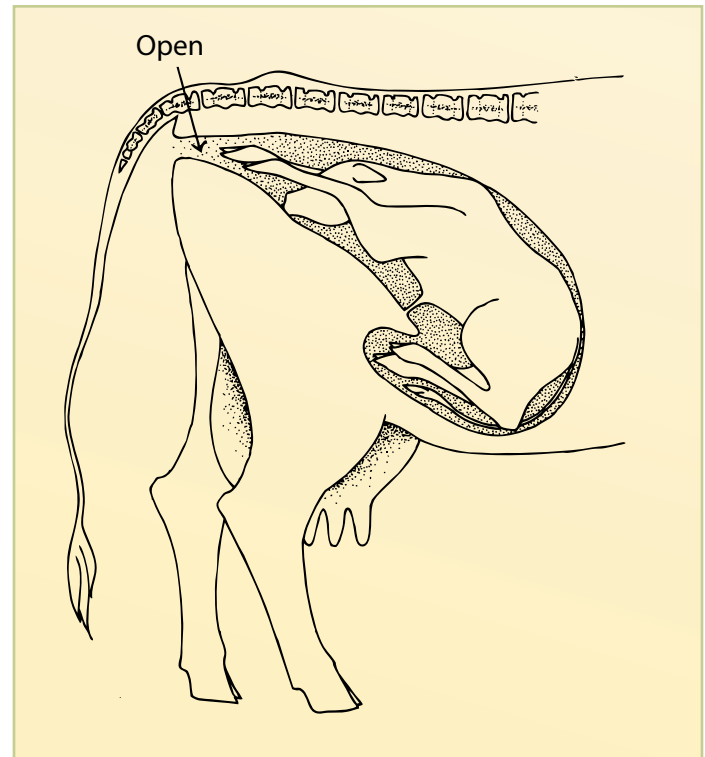
## Stages of Labour

### Stage I: Relaxation

The pelvic girdle through which the calf must pass at the time of birth is normally a firm, bony ring. Just prior to calving, the joints and ligaments associated with the pelvic girdle become more elastic and allow both the vertical and horizontal diameters to increase. This facilitates the passage of the calf.

The relaxation of the ligaments around the tail is a sign commonly used to identify cows that are preparing to deliver a calf. As well, the external opening into the birth canal (vulva) becomes swollen and discharges a clear mucous material. The udder becomes noticeably enlarged. The animal is uncomfortable and restless, separates herself from the herd, looks or kicks at her flank and continually lies down.

Just prior to calving, the muscles of the uterus (calf bed) contract rhythmically, with the time between periods of contraction becoming progressively shorter. These uterine contractions are involuntary. The cow is unable to control them as the secretion of hormones brings them on. The contractions force the calf, which is surrounded by fluids and fetal membranes, towards the cervix (neck of the womb). Meanwhile, the cervix itself is undergoing relaxation, and the pressure of the contracting uterus forces some of the membranes (water bag) through the opening (Figure 28). Once a portion of the fetus protrudes through the cervix into the vagina, reflex stimuli result in voluntary pushing or straining by the strong abdominal muscles and the first stage of labour ends.



**FIGURE 28.** Normal position prior to birth

### Stage II: Active Labour

As the calf enters the birth canal, the involuntary contractions of the uterus are now strongly reinforced by contractions of the powerful abdominal muscles. These combined contractions, plus the movements of the calf, mould the calf to the shape of the birth canal as it is expelled through the vulva. Most animals lie down as soon as straining commences. The time required to complete the second stage of labour is from 30 to 60 minutes in a cow, and up to three hours for a first-calf heifer.

### Stage III: Involution

After the calf has been delivered, the uterus continues to have contractions for several days. The placenta (afterbirth) is usually expelled within six hours of the birth, but the uterine fluids continue to be discharged from the vulva in variable amounts for up to two weeks. After an uncomplicated calving, complete involution of the uterus (its return to normal size and tone) takes between 30 and 40 days. It may take longer after a difficult birth or in the case of retained placenta.



## Calving Problems

### Problems that Could Occur in Stage I

Uterine inertia, or loss of activity of the uterus, causes the cow to show some of the early signs of labour, but the cow fails to commence actively attempting to deliver her calf. This may be caused by a number of factors including poor nutrition, over-condition (too fat), an abortion or the presence of disease such as mastitis. In cases of uterine inertia, consult a veterinarian.

Non-dilation of the cervix causes signs similar to those for uterine inertia, as the cow usually does not go into active labour. During pregnancy, the cervix is about the size of an orange and has a very narrow undulating passage through the centre. Then at the time of calving in a normal pregnancy, the cervix enlarges and the cervix membrane softens, partly through the actions of hormones, to allow the passage of the calf. The dilated cervix will feel like a thin band of tissue that intrudes into the vaginal

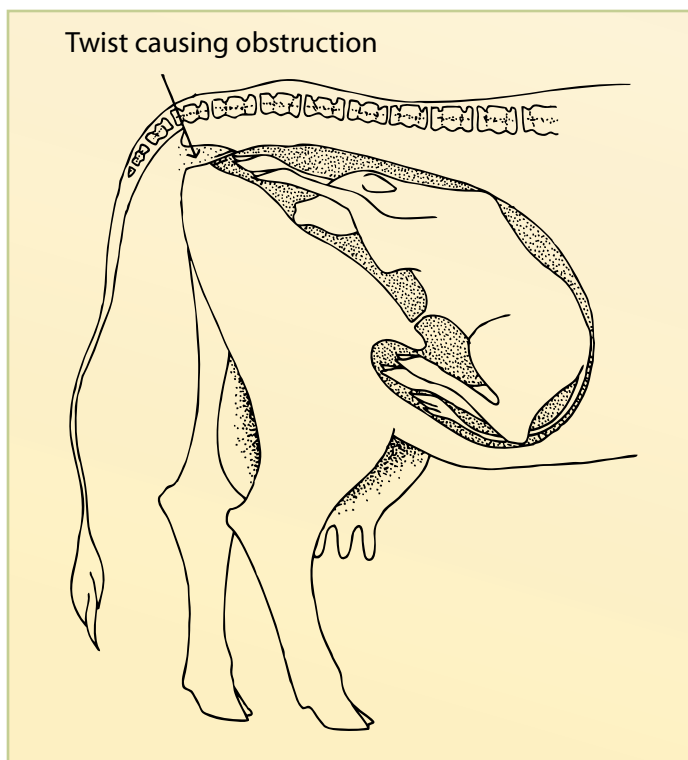
vault. Attempts to physically force the passage of the calf may result in irreparable or fatal damage to the cow. Consult a veterinarian if the cervix does not dilate, as a caesarean section may be needed.

### Problems that Could Occur in Stage II

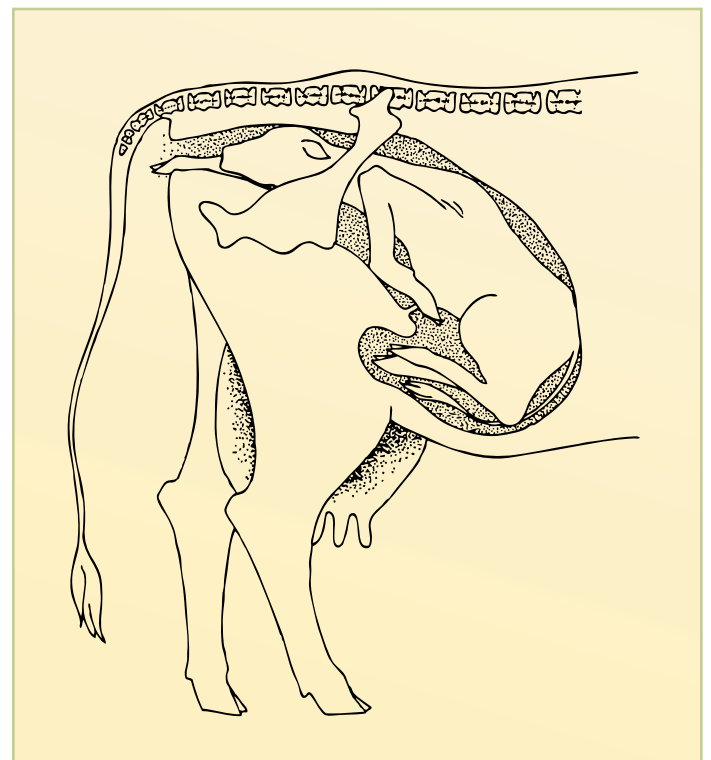
There are two types of difficult births: maternal difficulties, related to problems with the mother; and fetal difficulties, related to problems with the calf.

Maternal difficulties can include a pelvis too small to accommodate the calf, pelvic abnormalities (e.g. fractures, deformations, abscesses), uterine inertia usually brought on by fatigue (as in Stage I) and a rotated uterus (uterine torsion) that results in the twisting of the vagina (Figure 29).

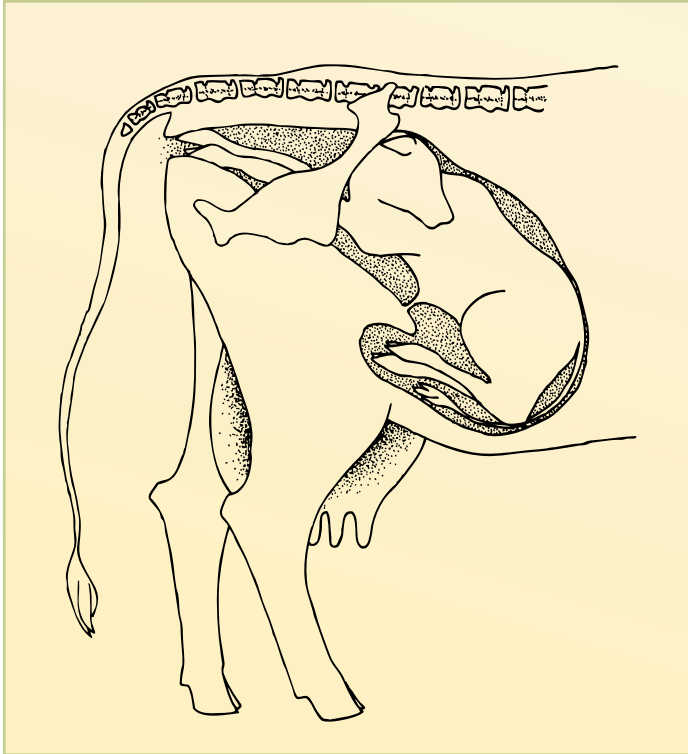
Fetal difficulties can include excessive calf size, an abnormally formed calf, abnormal positioning of the calf (Figure 30 and Figure 31) and multiple births (Figure 32).



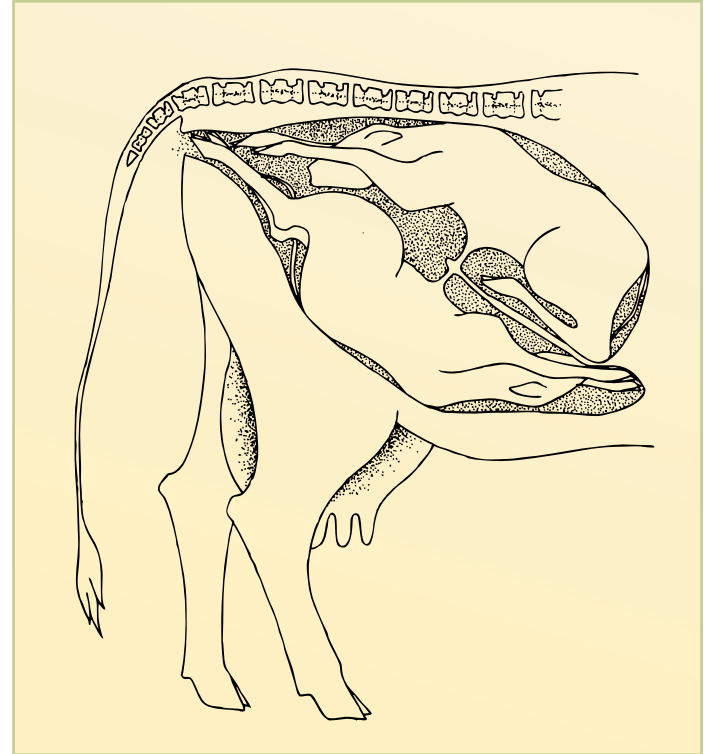
**FIGURE 29.** Uterine torsion



**FIGURE 30.** Dystocia caused by postural defects of the calf



**FIGURE 31.** Dystocia caused by the calf's head turned to the side or back



**FIGURE 32.** Dystocia caused by twins

## Assistance with Calving Difficulties

There are six important rules when handling a cow with a calving problem.

*Use clean chains to pull a calf.*



**Know when to intervene:** If intervention is too early, damage may be inflicted on the cow while trying to remove the calf. On the other hand, if intervention is delayed too long, the chance of delivering a lively calf is greatly reduced because of swelling of the cow and the calf, and weakening of the calf. As a general rule, if a heifer has been actively pushing for more than an hour and is not making any progress, intervention may be necessary. In the case of a cow, 30 minutes of active labour should be resulting in progress towards delivering the calf.

**Be clean:** Use clean chains or calving straps that have been boiled and kept clean. Wash the cow's external genitalia and your arms with lukewarm water to which a mild disinfectant or surgical scrub has been added. If the cow defecates while you deliver the calf, stop and clean up again so as to minimize contamination of the cow's uterus. Keeping clean reduces the chances of uterine infections.

**Be gentle:** Although force is sometimes needed to extract the calf, considerable strength and stamina may be needed to correct a displacement. The power used has to be directed with intelligent understanding of what is happening. The art of delivering a calf lies in the ability to mould the shape of the calf and vagina in such a manner as to allow the calf to slide through the pelvic canal. A combination of judiciously used power and intelligent feeling for the shapes and contours can result in a gentle delivery.

**Don't pull unless there are three parts of the calf in the birth canal:** There must be three parts of the calf in the birth canal before you start pulling. If the calf is being delivered head first, there must be two front feet as well as the calf's nose in the birth canal. If the calf is being delivered backwards, there must be two hind feet as well as the calf's tail entering the birth canal. An absence of one of these three parts is an indication of an abnormally positioned calf and will prevent its delivery. Pulling when fewer than three parts are in the canal may make correction of the problem more difficult as well as increase the risk of death of both the cow and calf.

**Know your limitations:** This is difficult advice to follow because the greater one's experience, the easier it is to recognize the limitations of any particular method of delivering a calf. In most adult cows the difficulty during delivery involves extremely large or abnormal calves, multiple births, uterine twists or a large, rotten (dead and decaying) calf. The risk of damage to the cow is minimized if the operator has acquired the experience to handle difficult births. In each of these cases, the problems are usually associated with the amount of space inside the mother, relative to the calf. Again, experience allows the operator to decide whether a caesarean will prevent damage to the mother or the loss of the calf.

**Limit the time that you work on the animal:** If distinct progress is not obvious within 10 or 20 minutes, call your veterinarian. Loss of time means loss of lubricating fluid, swelling of the vagina and less space to work, exhaustion of the cow, reduced viability in the calf and increased difficulty in correcting the problem.

## Tips on Calving a Cow Having a Calving Problem

1. Have a clean, well-bedded area in which to work.
2. Assess or prepare for any calving difficulties. If a calf is mal-presented (e.g. one or both feet are back while the head is in a normal position), it may be necessary to intervene and correct the calf's positioning. Once that is done, you need to judge whether to further assist the calving process or not. In the case of heifers, it is better to assist earlier rather than later.
3. If you decide to help the animal, get ready first. Wear clean clothes, plastic disposable sleeves and latex gloves. Wear the latex glove on top of the plastic sleeve. The glove will help hold the sleeve in place and will provide you with a better grip than the plastic disposable sleeve. Assemble your helpers, ropes, chains, lubricants, hot water, navel-disinfectant and clean cloths.
4. Tie the cow's head securely at a level to allow her to lie down or get up.
5. Normally, a calf is delivered head first. In this situation, the head must always be dealt with first. If the head is back, it must be brought fully into the pelvis. If necessary, a thin rope, chain or head snare may be placed around the head, behind the ears, and the loop drawn snugly into the mouth. Never place the rope or chain solely on the lower jaw as pulling on it will cause a broken jaw. With the head secured, the legs may be dealt with. The feet are then lifted into the pelvis by placing the hooves in the cup of your hand. This prevents the hoof tips from tearing the wall of the uterus.
6. Pull gently in time with the cow's contractions. Ease the calf's elbows over the brim of the cow's pelvis so that they don't jam. Pulling first on one leg and then the other copies the calf's normal birth movement and reduces the width of its body. Pulling two legs at the same time

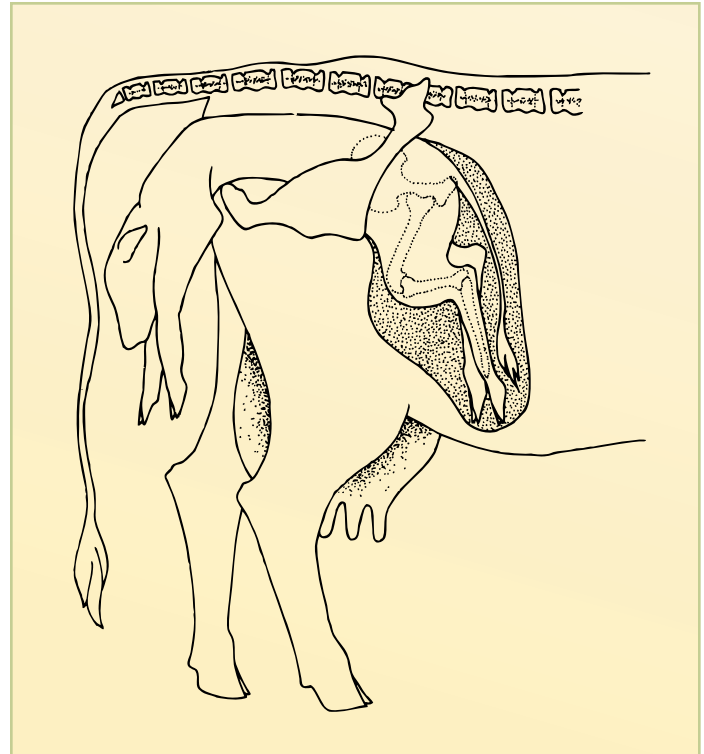
greatly increases the diameter of the calf. If the cow's passage is getting dry, lubricate the calf's coat with lard, vegetable oil or manufactured lubricant. Common cooking lard will stick to the coat longer than the more expensive jellies and greases that can be purchased as "obstetrical lubricants."

7. If the calf becomes stuck at the hips (hiplock, Figure 33), it is best first to introduce a lubricant (lard) around the hips. Then try to twist the calf on its side. The assistants should commence pulling as the operator presses gently up and down on the calf's middle. Pull the calf straight down if the cow is standing. If the cow is lying down, pull the calf through her hind legs towards her belly. If possible, lift the cow's hind leg vertically into the air to rotate the cow onto her back while simultaneously pulling the calf through to her belly. This rotation often changes the position of the calf relative to the cow and frees the calf to slide through the birth canal. Be careful not to get kicked.

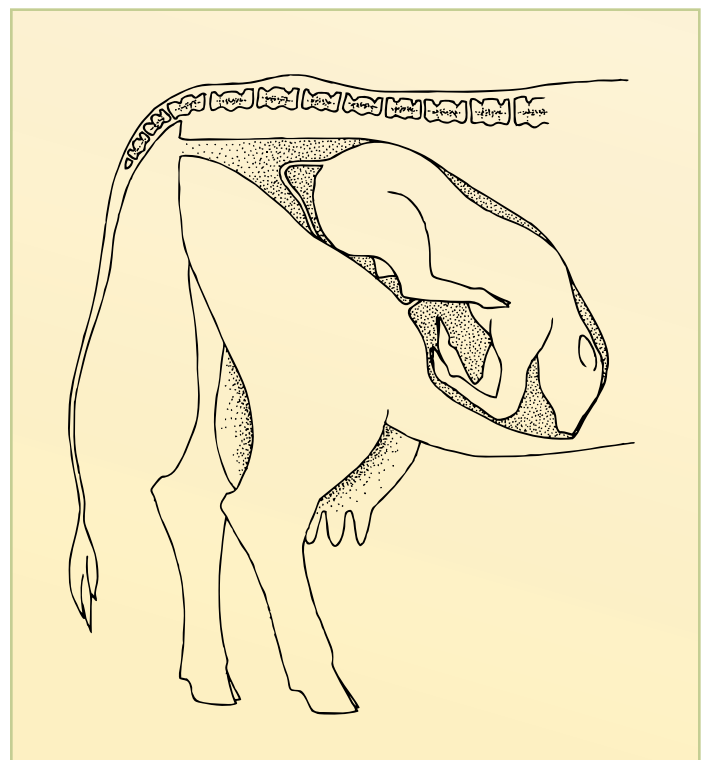
8. Calf pullers (chains or straps) are often used, but all too often they are used unskillfully and the calf or cow is damaged. Only use the calf puller to replace the strength of your own body. Use it to prolong your own stamina rather than to increase the torsion on the calf. Be aware that the calf puller can supply enough torsion to kill the calf and rip the birth canal of the cow.

9. The legs indicate if the calf is coming backwards. A front leg can be easily differentiated from a hind leg as the front leg has two joints, the knee and the fetlock (ankle), between the hoof and the elbow. The hind leg has only one joint between the hoof and the hock (Figure 34). Front legs have the bottom of the hoof facing downward as they are proceeding through the birth canal. When hind legs come first, the bottom of the hooves will be facing upward as they pass through the birth canal.

10. Although backward calves are often born successfully, the risk of complication is much greater than with forward born calves. Because the head is one of the last



**FIGURE 33.** Dystocia caused by a hiplock



**FIGURE 34.** Breech presentation



parts to leave the birth canal when the calf is born backwards, the birth fluids do not drain as well when the calf is being born. Also, the navel cord is sometimes broken sooner during calving. This results in the calf needing oxygen before the birth is completed. Drowning can sometimes result. Because of the increased risk of complications, consider helping the cow give a quick and expedient birth as prevention. When pulling the calf, take care that the tail of the calf does not turn back over the thigh as it may tear the roof of the vagina. As with the forelimbs in a headfirst delivery, be sure to pull first on one leg and then on the other. If you try to draw the two hips through the pelvis at the same time, the diameter of the calf will be greatly increased.

11. With the hips through the birth canal, pull straight back in a horizontal line to prevent the ribs of the calf hooking on the pelvis of the cow. Once out, raise the calf by the hind legs for a minute to allow any fluids to drain from the calf's lungs.

These tips cover the simplest needs in assisting a difficult birth. When dealing with more complicated situations, be quick to seek experienced help. This is one time to recognize your limited experience and to seek the help of an experienced neighbour or your veterinarian.

## After-calving Problems

**Vaginal tears or lacerations** are commonly seen after difficult calving, especially in heifers. Usually, no special treatment is required unless the tears become infected. In such cases, antibiotics may be needed. Deep lacerations require the attention of a veterinarian soon after they occur.

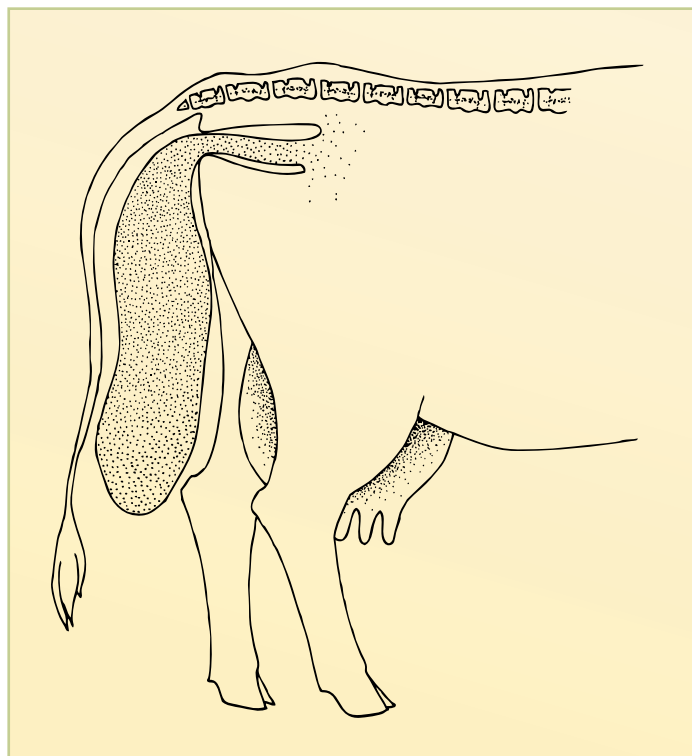
**Uterine tears** require the immediate attention of a veterinarian as the cow is in grave danger. If fresh, bright red blood is seen coming from the anus or vagina there may be a uterine tear. If a uterine tear is suspected, then have a veterinarian do a vaginal exam after calving.

A **prolapsed uterus** occurs when a cow continues to push after calving. This eventually forces the uterus through the vulva inside out so it hangs out behind the cow, down to her hocks



*Care should always be taken when using equipment to pull a calf.*

(Figure 35). This is an emergency situation to which a veterinarian should be called immediately. Do not try to place the uterus back inside the cow yourself. If possible, the uterus should be wrapped in moistened sheets until it can be reinserted. However, it is critical to keep the cow quiet, to prevent injury to the uterus. If a cow continues to push after the calf is born, forcing the animal to stand and move around may prevent a uterine prolapse.



**FIGURE 35.** Uterine prolapse

**Hind leg paralysis** is a condition where a cow is unable to get up on her hind legs after calving. Delivery of an exceptionally large calf or using excessive traction during delivery can cause damage of the nerves to the hind legs of the cow where they pass through the bones of the pelvis.

There is no specific treatment for this paralysis, and it should not be confused with milk fever (low blood calcium). Allowing the cow to rest in a well-bedded stall and periodically rolling her from side to side to prevent bedsores is helpful to prevent further damage to the hind legs. In many cases the cow will eventually re-establish herself and resume activity. It is wise to consult a veterinarian about any cow that fails to get up shortly after calving.

**Retained placenta** can occur following a normal birth. This occurs when the uterus fails to expel all of the fetal membranes (placenta) within 12 hours of the birth of a calf. There are many causes of a retained placenta including dystocia, twinning, abortion or premature birth, and nutritional deficiencies. If the incidence of retained placenta exceeds eight to 10 per cent of the calving cows, consult a veterinarian to determine the cause.

Do not attempt to peel the fetal membranes off the caruncles (fleshy masses or knobs on the uterus wall) of the uterus because there is a high risk of bleeding or infection, resulting in reduced fertility in the following breeding period. The placenta is best left alone or simply cut off where it hangs out of the vulva. This prevents it from acting as a wick, allowing infection to travel up into the cow's uterus. Sometimes antibiotics are placed in the uterus to control the infection. However, antibiotics slow the decomposition of the placenta and delay its passage.

If an animal with a retained placenta loses her appetite or seems dull and lethargic, she may have an elevated temperature. Injections of an antibiotic should be given until the problem clears up. A veterinarian should do a postpartum examination of the uterus of this cow within a month after calving to make sure that the uterus is involuting normally and the infection is clearing up.



*Newborn sucks for the first time.*

## Care of the Newborn Calf

Normally, a calf spends a few moments orienting itself to its new world before progressing to the next step. Think of the calf needing to go through a series of first steps as it becomes established in the world. The first steps end when the calf has nursed and taken its first nap. After that, any of the important parts of the calf's life are a repeat. In most cases the calf is able to work its way through those first steps on its own, with little assistance from its mother. The following is the sequence of needed steps for the calf to get established:

1. The calf needs to clear its lungs and throat, and begin to breathe.
2. The calf needs to be able to lift its head and maintain its head with a sense of balance.
3. The calf needs to realize that it has front legs that are often tucked under while lying down.
4. The calf needs to learn that the front shoulders can raise the front part of its body with its head extended.
5. With its shoulders and front upper legs maintaining balance, the calf can then use its back legs to lift its bum in the air.
6. Each back leg is needed to keep the bum in the centre and raised.
7. The front legs can be extended one at a time to place the hoof on the ground.

8. Both front legs can be extended along with the back ones to keep the body raised in the air.
9. All four legs and its head are needed to maintain balance while the cow is licking the calf dry.
10. The legs need to be extended in a particular order to move the calf forwards.
11. The calf then needs to learn that the udder of the cow is at the back of the cow and not around her front shoulders or around her brisket.
12. Once the udder is recognized, the calf needs to discover the elevation of the cow's teats, to open its mouth to get a teat into its mouth and to put a teat in rather than wads of manure or long hair on the udder.
13. With the teat in its mouth, the calf needs to learn to apply suction on the teat and to begin to pump the teat with its lower jaw.
14. Once the milk is flowing, the calf needs to learn to hang onto the teat and continue pumping to get more milk; as butting its head on the cow's udder and letting go is counterproductive to getting more milk at this time.
15. Finally, the calf needs to learn to find a comfortable place to lie down and have a nap.

Everything from here on is simple and basically repetitious.

Although these 15 steps may seem rather detailed and sometimes insurmountable, each one is necessary for getting a calf established in its new world. Any complications, either from the calf, the cow or the outside world, delay the progress of the calf. As a helper to a calf, it is important to know the hurdles the calf needs to deal with in its early hours and to recognize when to step in and help. It is also important to know when to give the calf more time to master the hurdle on its own. In cases where too much time and energy are needed, it is possible that the calf will quit trying and eventually

become weak and die. However, in most cases the calf is quite resilient and will rest and try again. When the outside temperatures are colder, it is more critical for a calf to progress through these steps, as it needs its first milk in a timely manner.

Most calves are able to successfully progress through these first steps, but complications can arise. Usually, beef calves will suckle unassisted for the first time at a very young age. Approximately 50 per cent of beef calves suckle unassisted for the first time by two hours of age. Close to 90 per cent of beef calves suckle unassisted for the first time by five hours of age. The following information covers some areas where assistance is needed.

## Calf Not Breathing

Resuscitation is aimed at establishing proper respiration and blood circulation. If a calf fails to breathe within 10 to 15 seconds after birth, place it in the dog sitting position. Pull both back legs straight back to allow both lungs to oxygenate evenly. Avoid prolonged hanging or swinging as it may result in the stomach contents being emptied out of the esophagus. If the calf gasps, the contents can be inhaled into the lungs. Next, wipe the nostrils and mouth clear of mucous with a clean cloth. Then, vigorously massage the chest wall to get the calf breathing. Stimulants for a sluggish calf include snow or cold water poured in the ear, or a straw up the calf's nostril.

If the calf is still not breathing, a few gentle puffs of oxygen may be required. This is provided by doing mouth-to-mouth resuscitation. Be sure to use only shallow puffs because excessive inflation may rupture the calf's lungs. If there is evidence that the heart has stopped, a sharp slap on the calf's chest over the heart may help.

## Calf Shivering

Although some shivering is normal even in warmer temperatures, calves born in below-freezing temperatures lose body heat quickly and lose energy from shivering to the point of becoming numb. To prevent this, it is wise to place the calf in a warm place where it can dry off and become oriented. This may require that you take



the calf from the cow for a short time. Even though the cow will be anxious that her calf is missing, she will be quick to reunite once you bring the dried-off calf back.

## Calf Unable to Find Cow's Teat

Typically there are two reasons why the calf cannot find the teat. The first relates to the calf's inability and the second relates to the cow.

When the calf is unable to find the teat, it usually is because the birth was quite difficult or because the temperature has caused the calf to chill to the point of being incoherent. In both cases, you need to intervene and provide the calf with some colostrum (the first milk from the cow after the calf is born) either through sucking or through stomach tubing. If vigorous nursing by the calf has not started within two to three hours of birth, colostrum should be given to the calf at the rate of five to six per cent of its body weight using a bottle and nipple, or an esophageal feeder. After a difficult birth, calves often do not nurse for up to 12 hours. It is important to administer colostrum to these calves as soon after birth as possible and to make sure the calf is nursing normally within 12 hours. More information about colostrum is provided in the next section.

If the calf is able to nurse, but cannot because of the cow's shape, help must be given. Sometimes the cow's udder is too low and the calf needs to learn that it has to reach down instead of up to nurse. The shape and size of the teat may be long and

tubular or large in size, making it hard for the calf to grasp the teat. In these cases, the cow needs to be restrained, the calf needs to be pointed towards the udder and the teat must be pointed towards the nose of the calf. With the calf searching for the teat, the feel of the teat on the calf's nose will often trigger it to search out the tip, latch onto it and suck. Being patient with the calf is critical. Also make note of the cow's poor udder and teat development, and consider culling the cow in the fall. Poorly shaped udders and teats are a labour issue and should not be tolerated. Often the physical attributes of a cow are passed on to her daughters, which will increase the problem as the daughters become cows.

If the calf is unable to nurse because of the cow's temperament, there are a couple of options to try. The first is to restrain the cow and let the calf try to suck the cow. Restraining the cow gives the calf a better chance of nursing and learning where to find its milk. Another option is to separate the calf from the cow, give the calf colostrum from another source and then put the cow and calf back together in a quiet pen. This allows the two animals to become used to each other. Depending on the nervousness of the cow, you may also want to add her to the cull list. Remember that the calf does not have to be culled because temperament is a learned attribute.

## Meeting Colostrum Needs

Colostrum of good quality and in sufficient amounts is extremely important for the health of the calf. Colostrum helps to build disease immunity in the newborn calf. For example, it plays an important role in helping to prevent scours. The following factors need to be considered to ensure that the calf gets enough good quality colostrum soon after birth.

**Cow nutrition and colostrum:** Cows should receive proper nutrition throughout the winter to avoid calving difficulties and to produce sufficient volumes of colostrum with high nutritional and immunoglobulin levels. Immunoglobulin acts as an antibody improving the newborn calf's resistance to disease. Poor cow nutrition can also result in weak calves that cannot stand to nurse or survive extreme changes in the weather. Thin cows also deliver thin calves, with little insulation against cold, wet weather.

*Assisting a calf to find the cow's teat.*





**Heifers and colostrum:** In comparison to cows, first-calf heifers produce less colostrum and their colostrum may have a 25 per cent lower concentration of immunoglobulins. The incidence of calf scours is usually at least twice as high in calves from first-calf heifers, when compared to the calves from older cows. Older, multiparous (multi calves) cows have been exposed to more organisms and so the quality and quantity of their colostrum is higher. Generally, heifers mother calves less well than do older cows. In addition, they tend to have more calving difficulties, which also results in weaker calves. With the combination of these difficulties it is little wonder that calves born to first-calf heifers often do not receive sufficient colostrum protection.

**Vaccination programs:** Vaccination helps to increase the immunity provided by the cow's or heifer's colostrum.

**Colostrum timing:** The newborn calf has two kinds of immunity: nonspecific immunity against infection in general and specific immunity that protects against particular infectious agents. For maximum nonspecific immunity, a calf must receive a large amount of high quality colostrum soon after birth. After nine hours, an average calf will absorb only 50 per cent of the immunoglobulins in the colostrum that it would have absorbed if it had been fed the same colostrum right after birth. A calf can absorb very little immunoglobulin in the colostrum after 24 hours. This is a problem for calves that are weak following prolonged delivery. Often, they will not nurse for 12 or more hours after their birth. This greatly reduces their nonspecific immunity level. Newborns should be fed colostrums as soon as possible after birth. Calves that receive inadequate colostrum are three times more likely to become sick. The occurrence of sickness in older calves (in the feedlot) is higher in those calves that were colostrum-deficient as newborns.

**Colostrum volume:** Calves should receive a volume of colostrum at least equivalent to five per cent of their body weight before six hours of age (e.g. 1 L (1 quart) for 22 kg (50 lb.) of body weight). Whether real colostrums or substitutes are used, be sure to give at least 100 grams of immunoglobulins in the first six hours to provide adequate protection for the newborn calf. Stored colostrums and purchased colostrums can be

checked for immunoglobulin levels. Most good quality colostrums contain 60 to 100 g (2 to 3.5 oz.) of immunoglobulin per litre, so you need to have 1 to 2 L (1 to 2 quarts) on hand for the newborn calf.

**Colostrum sources:** It is not necessary for a calf to receive colostrum from its own dam. Colostrum from high producing cows or a neighbour's dairy cows may be stored frozen in plastic bags or containers until it is needed. It is important to make sure that your colostrum is only from the first milking.

Always have frozen colostrum on hand for emergencies. Treat it as a precious commodity. When thawing colostrum, do not overheat it. Use a hot water bath or the microwave on defrost. Pour off the thawed portion frequently. Although not desirable, freezing and thawing the product several times does not appear to have harmful effects on immunoglobulin levels. Try not to use colostrum that has been frozen for more than one year.

Real colostrums are still best, although several commercial dried products do provide some benefit. Most commercial products are classified as colostrum supplements, but nothing is a substitute for the real thing. One product, Headstart<sup>®</sup>, is actually real spray-dried colostrums from older dairy cows. Each container contains 60 g of immunoglobulins.

**Supplying colostrum to the calf:** Calves that are weak or unable to stand at birth require special attention. If they have not nursed within one or two hours, they should either be helped to stand and suckle or the dam should be milked out and the calf fed by nipple bottle. Twins may need to be supplemented with extra colostrum.

Contrary to former beliefs, drenching (taking liquid by mouth) or tubing using an esophageal feeder to give 1 to 2 litres (L) does provide the same benefit as sucking the colostrum, but the calf is stimulated more from the sucking reflex. If after 10 minutes the calf is unable to get milk from the teats, gently tube feed the calf. It is important to make sure you feel the feeder go down the esophagus before releasing the milk.

Do not use the same nipple bottle or esophageal feeder to give colostrum to newborn calves as the one used for giving oral electrolyte fluids to sick and scouring calves. Clean and disinfect equipment after each use.



*A cow guards her newborn calf.*

## Care of the New Suckling Calf

The period from birth to weaning is the time that the calf is part of the herd and receiving most of its nutrients from its mother's milk. It is also learning to socialize and consume forage from the pasture.

Shortly after the calf's birth is usually the best time to carry out some processing procedures that cause short-term pain for long-term gain. The major procedures include identification, vaccinating, castrating and dehorning. Beef calves have more market value if they are properly dehorned, castrated and vaccinated. Calves tolerate almost any stressful procedure better while they are still on the cow than after they have been weaned. Where possible, cows and calves should be given a few days to "mother-up" and rest after any of these procedures have been performed. This is particularly true if the cattle are to be moved any great distance.

### Processing Procedures

After the calf has nursed and is on its feet, there are several procedures to consider doing while the calf is young and easy to handle. This is a good time to disinfect the calf's navel, provide identification, castrate and dehorn. Doing these procedures while the calf is a very young offers the least stress for the calf and you. With experience, one person can effectively restrain a one-week-old calf and do all the necessary operations.

Instruments used in castrating and dehorning must be kept clean and disinfected thoroughly before each use. This will prevent infected wounds. Operators should keep their hands clean and wear clean latex surgical gloves. Make sure the area of castration or dehorning is clean and free of organic material, by washing the area with warm, soapy water. Application of antiseptics to the calf's skin before castration or dehorning is of little benefit, unless the hair is shaved and the area scrubbed with soap several times. Cleanliness can be greatly aided by having available one or more buckets of warm water containing a disinfectant to rinse off the instruments and the operator's hands. The instruments should also be soaked in the bucket between animals. Consult with your veterinarian on specific disinfectants.

### Disinfecting the Calf's Navel

Disinfect the navel thoroughly as soon after birth as possible. Use products recommended by the pharmaceutical companies that are non-irritating and allow the natural closing of the calf's navel. This is especially important where calves are born in confinement. Calves that are born on pasture, where the possibility of infection is minimal, may not need their navels disinfected.

### Identification of the Newborn

Calf identification is necessary for herd management, performance testing, national disease surveillance and pedigree tracking.

**Ear tagging:** Ear tagging with plastic dangle ear tags is the method of choice for identifying calves for day-to-day herd production management. Ear tags should be large enough for the numbers to be visible from a distance. Several numbering systems are practical for identifying animals. The most common method assigns an industry-recognized letter to the year the calves are born. Table 24 provides the industry-standard chart of letters assigned for the years past and years to come. By combining a number and a letter for the calf's identification, the calf can be identified by its birth year and its individual number. For more permanent national cattle identification, the calf can be tagged with the Canadian Cattle Identification Agency (CCIA) ear tag. The CCIA ear tag is in addition to the original herd ear tag.

TABLE 24. Industry-standard designating year letters

1991 – A	1999 – J	2007 – T
1992 – B	2000 – K	2008 – U
1993 – C	2001 – L	2009 – W
1994 – D	2002 – M	2010 – X
1995 – E	2003 – N	2011 – Y
1996 – F	2004 – P	2012 – Z
1997 – G	2005 – R	2013 – A
1998 – H	2006 – S	2014 – B

**Tattooing:** Under the Canadian Livestock Pedigree Act, tattooing is required for all registered and recorded cattle. Tattooing should be done shortly after birth, unless calves are individually identified in some other manner such as ear tagging. When tattooing, take care to ensure that the letters are securely fastened in the head of the pliers. Test to make sure the numbers and letters are in the proper sequence by applying the pliers to a piece of cardboard. Make sure that the calf's ear is properly cleaned, the tattoo is properly positioned and applied, and the tattoo ink is well rubbed in. Never use ink that has been frozen. Tattoo equipment should be cleaned and disinfected after use on each calf.

**Electronic identification:** Electronic identification, either as an implant or as a button tag within the ear, has the advantage of being permanent. Reading these electronic devices is usually done within the handling facility or feedlot. Computers can then be used to track information about individual animals. Records are kept about feed ration, water and mineral consumption, and sickness. One disadvantage to electronic identification is that it is not visual. For day-to-day use on the ranch, ear tags can supplement the electronic tags.

### Castrating the Newborn

Bull calves are castrated, as steers are easier to handle and present fewer problems than bulls. In addition, when slaughtered, a smaller proportion of steers grade B4 (dark cutting) than bulls. B4 carcasses are discounted so castrating improves the market value of your calf. The stress of castration can be minimized if done shortly after birth. Baby calves are easy to handle for the first 36

hours of life and this is an ideal time for castration. Another alternative is to wait and castrate baby calves in groups. This is acceptable as long as all calves are castrated before three months of age. Two common methods used for castrating at an early age are to use a rubber ring or to surgically remove the testicles.

### ANATOMY

Before beginning castration, one needs to know a little about the anatomy of the area. The testicle lies inside the scrotum, in a membranous bag (Figure 36). The scrotum is divided into two halves by a membrane called the scrotal septum. This bag is connected directly to the abdomen by means of a tube. A tough, strong membrane called the vaginal tunic covers each testicle. This membrane covers each testicle and needs to be removed during surgical castration or swelling and infection are more likely to result. The spermatic cord attaches to the top of the testicle. The cord carries sperm from the testicle and it contains all the blood vessels that supply blood to the testicles. Where the cord is close to the testicle, these vessels are thickened and twisted. The cord and blood vessels become thinner the further they are from the testicles. The testicles produce the male hormone (testosterone) and sperm.

The first step in any castration procedure is to examine the scrotum. Check to make sure that

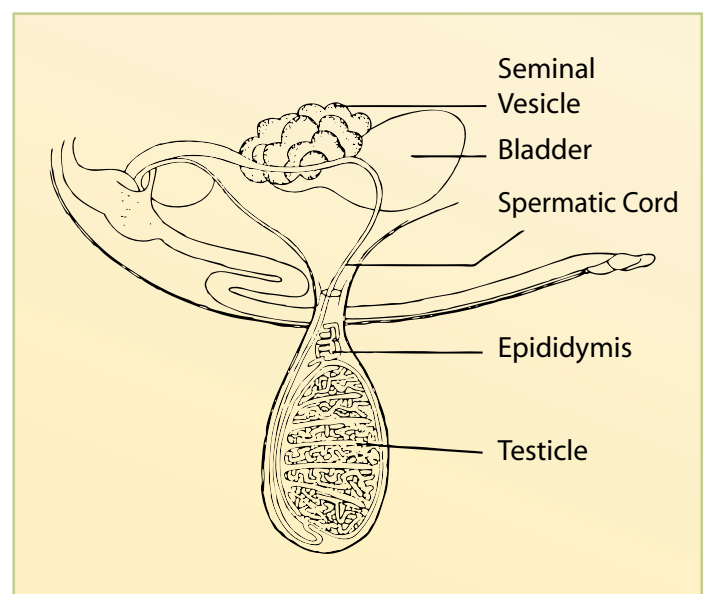


FIGURE 36. Testicle and associated organs

there are two descended testicles. Removal of these testicles is the objective of castration. If only one testicle is found during the examination, the other one is probably up in the abdomen and this calf should not be castrated. Contact your veterinarian for help.

## CASTRATION METHODS

**Elastrator rings:** Elastrator rubber rings should be used on calves before they are one month of age. First put the rubber ring on the elastrator instrument (forceps-like instrument) and press the handles several times to stretch the ring. Close the handles to open up the rubber ring. Slip the ring up and over the scrotum, until the ring is placed below the scrotum's attachment at the groin. Pull the scrotum down and make sure both testicles are completely below the elastrator ring. Open the handles, releasing the elastrator ring, allowing it to close on the neck of the scrotum and remove the applicator off the ring. The pressure exerted by the rubber ring restricts the blood supply to the testicles. Within a few weeks the testicles have shrivelled up and dropped off. When castrating with a rubber ring, always recheck that both testicles are in the scrotum before the ring is released from the elastrator. If one of the testicles is not in the scrotum, then that testicle will be squeezed up into the body cavity. If this happens, the testicle continues to generate hormones that cause bullish problems as the animal grows older. Surgery to remove an ingrown testicle at an older age is a complicated job that results in both expense and suffering.

**Surgery:** Testicles can be removed surgically from a bull of any age, but the risks and potential complications increase greatly with age. It is recommended that surgical castration be done on calves less than three months old. Place the calf on a calf table or stretch it out on its side on the ground. Cleanliness, control of hemorrhage and adequate drainage of the incision are the most important factors in surgical castration. Use a sharp knife kept in a container filled with disinfectant solution.

When castrating surgically, first open the scrotum to expose the testicles. An important point to remember is that a larger opening is always better than a smaller one. Smaller openings do not allow adequate draining and could result in a much higher incidence of infection following castration. One method of opening the scrotum for calves under eight weeks of age is to cut the bottom one-third of the scrotum off (see Figure 38) with a scalpel or sharp knife. The bottom of the scrotum is pulled down and back with one hand, while the other hand cuts off the bottom of scrotum from side to side. Be careful not to cut the testicles, your other hand or the big vein inside the calf's leg. The two testicles will appear. This type of cut may result in the wound closing too quickly as it may not have adequate drainage.

Another method to open the scrotum is to push the testicles up in the scrotum toward the abdomen. Then insert the knife into the side of the scrotum below the testicles (see Figure 38). The knife should extend completely through the scrotum and out the opposite side. Cut the scrotum into two halves from there down. This type of incision will provide good drainage and is less likely to close too quickly when healing.

Once the scrotum is opened, proper removal of the testicles is next. Grasp and pull each testicle completely out of the animal's body. Keep pulling slowly on the testicle until you feel the muscle in the spermatic cord separate. Separating the muscle first reduces the amount of bleeding that occurs. Also the calf now cannot pull the testicle back up. The exposed spermatic cord is then severed with a scraping motion high above the testicle, as close to the scrotum edge as possible. Scraping involves grasping the testicle and stretching the cord while scraping (like a shaving motion) on the cord with the knife, usually towards the abdomen of the calf. This allows for gradual separation of the cord tissues and vessels. **DO NOT CUT THE CORD.** Cutting the cord will result in excessive bleeding. Be sure that the end of the cord is not hanging out of the scrotum. Try not to let the testicle slip from your fingers as you are pulling, as the testicle will then take contamination with it back into the



scrotum. On very young calves (one to three weeks old), the testicle can be gradually pulled out until the cord breaks. On older calves, this may result in excessive bleeding or hernia development.

Another way of separating the cord is to use an emasculator (Figure 39), which is a specialized instrument designed to crush and cut the spermatic cord. To separate the cord open the emasculator's jaws and place them straight across one spermatic cord. Make sure the crushing side of the jaws is directed up. Make sure that no skin is caught within the jaws. Close the jaws of the emasculator and squeeze tightly for 15 seconds or more. Remove the testicle and do the other side.

The advantages of surgical castration are the speed with which the operation can be carried out and the certainty of getting both testicles. The younger calves are done, the less stress this places on both the calf and the operator. Failure and complications are minimal if this procedure is done correctly.

## Dehorning the Newborn

Cattle with horns often pose management problems. Horned cattle in the feedlot use more bunk space, prevent other cattle from feeding properly and may cause bruises that lower carcass values. The removal of horns from young feeder cattle has been shown to be stressful and reduce growth rates (Goonewardene et al. 1999). With dehorning, the younger the calf, the better the results. Dehorning early also lowers the levels of stress for the calf. Although using polled genetics (inherited lack of horns) within any breed is the simplest method for dehorning, there will still be horned animals born.

At birth, a calf has very small horn buds that feel like hard bumps on the calf's head. Two methods are available for removing these horn buds. For either method, restrain the young calf by holding it still on the ground.

The simplest dehorning method is to separate the hair around the horn bud to expose the bud, and then apply about 1 cc of dehorning paste to the skin on the bud. Be sure that the paste actually

contacts the skin and doesn't stay on the hair near the bud. After the treatment, keep the calf away from the cow for about one hour to let the paste penetrate the horn bud. Letting a treated calf out with its mother right away is dangerous because the cow may lick the paste off the horn bud.

The other method is to use hot iron dehorning, heated either electrically or by fire. These dehorning irons can be used very successfully on young calves up to two months of age. The ring should be smooth, about 3 to 5 mm (0.1 to 0.2 in.) thick, and have no more than a 4 cm (1.5 in.) outside diameter. After the iron has been heated to the proper temperature, it is pressed firmly over the horn button and held until the underlying tissue has been cauterized. The burn must be deep enough to destroy the horn tissue. After enough heat has been applied with the hot iron, the skin around the base of the horn has a smooth, brown, leather-like appearance. Many producers are using the electrically (110 AC volt) or battery-powered dehorning technique. The battery-powered dehorning irons are easy to carry out into the calving barn, field or pasture.

Relatively little after-care is required with the hot dehorning technique. The cauterized area peels off with the horn bud within four to six weeks. This leaves the calves resembling naturally polled animals. The advantage to this treatment is that it is quick and complete. The calf can be returned to its mother immediately after the procedure.

An alternative to dehorning is to breed cattle that have the polled gene. The polled gene is dominant to the horned condition. The perception exists in the beef industry that polled cattle are somewhat inferior to horned. A study of growth and carcass traits in dehorned (genetically horned) and polled bulls was conducted at the University of Alberta (Goonewardene et al. 1999). Dehorned and polled bulls were similar for birth weight, weaning weight, pre- and post-weaning average daily gain, carcass weight, grade fat, marbling, rib-eye area, cutability and carcass grade. Polled bulls had higher fat over the rib-eye. The similarity in growth and most carcass traits between polled and horned would suggest that breeding for polledness is just as good an option as dehorning.



*A healthy, suckling calf.*

## Management of the Suckling Calf

### Branding

Branding is not compulsory, but it has the advantage of being a permanent identification. In Alberta, a properly recorded brand is legally owned by the registrant. Animals carrying that brand have permanent identification to that registrant. However, this does not mean that the registered owner of the brand owns the animal. It is unlawful to knowingly brand animals that do not belong to you or use an unregistered brand. A brand should be applied in such a manner that it is readable under most conditions, and definitely when the hair is clipped.

The size of the branding iron is important. For use on calves under one year of age, the outside measurements of each character should be not less than 10 cm (4 in.) in height and 7.5 cm (3 in.) in width. An iron 15 cm (6 in.) high and 9 cm (4 in.) wide is recommended for grown cattle.

The hot iron method of branding is the most efficient. A good hot brand destroys hair follicles located under several layers of skin and leaves a permanent bald scar on the hide of the animal. Check your iron for temperature. A black iron is too cold; a red iron is too hot. An iron that is the colour of grey ashes is the proper temperature; it will produce a good brand, and the application should take only three to five seconds on calves. The job can be done quickly by pressing firmly and rocking the iron slightly to vary the pressure and obtain uniform application of the entire character.

At completion, the hide should be the colour of buckskin or new saddle leather. Burning too lightly makes only a temporary brand. Holding the iron on too long causes unnecessary pain and excessive burning, which may result in a wound that is difficult to heal. A botched brand, resulting from too much heat, is also difficult to read. Keep the iron free of scale and burnt hair by cleaning it with a wire brush or dipping it into a pail of sand.

Freeze branding is the other method of choice. With freeze branding, the irons are placed in liquid nitrogen and cooled. The cold irons are then placed on the skin. The freezing of the skin and hair follicles changes the normal colour of the hair. Where the hair follicles have been frozen, the hair grows back white in colour. The disadvantages are that freeze branding takes longer and the brand does not become visible for a few weeks after the procedure. In cases where timeliness is an issue, freeze branding may not be the appropriate choice. Also, it does not work well on white cattle or those that have white or light-coloured spots in the location of the brand.

### Vaccination

The proper vaccination program for calves varies somewhat from area to area. Consult your local veterinarian to assist in the development of a vaccination program that takes into account the diseases that occur in your area and any unique requirements your herd may have.

Some general guidelines for a vaccination program for calves in Alberta are:

- All calves should be vaccinated at two to three months of age with an 8-way vaccine for the prominent calf diseases.
- All calves should be given a booster before weaning time to develop a greater level of immunity. At that time calves should also be vaccinated for infectious bovine rhinotracheitis (IBR), bovine respiratory syncytial virus (BRSV), bovine viral diarrhea (BVD) and parainfluenza-3 virus (PI-3). If the cow herd has not been vaccinated for IBR, consult a veterinarian before the IBR vaccine is given to the calves to prevent disease reactions in the cows.



**FIGURE 37.** Shows proper Injection site

Consult with your veterinarian on the type of vaccine to use and the precautions required.

If possible, vaccinate subcutaneously (just beneath the skin) rather than intramuscularly (into the muscle). Research shows that vaccination into the muscle damages the muscle and any steak or roasts taken from that muscle. If injecting intramuscular drugs, inject them in the neck muscle behind the base of the ear and ahead of the shoulder point (Figure 37).

Watch for new vaccination developments (e.g. applied to the skin and oral).

## Castration

Ideally, if castration is done, it should be performed as early as possible in the calf's life. Calves can be castrated up to eight months of age. However, the older the calf is at castration, the greater the stress and the risk of bleeding. Also, there is a temporary reduction in the growth rate of older calves. Therefore, it is recommended that castration be done early, before eight weeks of age (refer to *Castrating the Newborn* in this section for more details on anatomy and technique).

Stress from castration can be reduced by doing the procedure quickly and cleanly. Use the correct equipment, and make very sure that it is clean and functioning properly. Treat animals humanely. Use experienced workers who are familiar with the proper techniques and who can do the procedure faster and with fewer problems due to hemorrhaging and infection later.

The calf should be well restrained to prevent additional injury at the time of the procedure. Restraint is easier when the calves are younger. With experience, one person can effectively restrain a one-week-old calf and do all the necessary operations. As the calves get older they become stronger and more co-ordinated, but they

can easily be restrained when they are thrown to the ground and held by two people. The use of a calf table greatly simplifies the restraint of calves.

With older animals, using a chute is the preferable restraint method. If a chute is not available, an animal may be tied to a fence with a halter. The animal is further restrained when an assistant pushes the calf into the fence and applies a tail jack. Tail jacking is an effective means of restraining an animal, but care should be taken when handling a scalpel for castrating as the animal may flinch and jerk.

Castration of the male calf is a simple money-making practice. Feeder cattle should be marketed only as steers or heifers. Castration of older calves can be done by surgery or bloodless castration.

## Surgical Castration

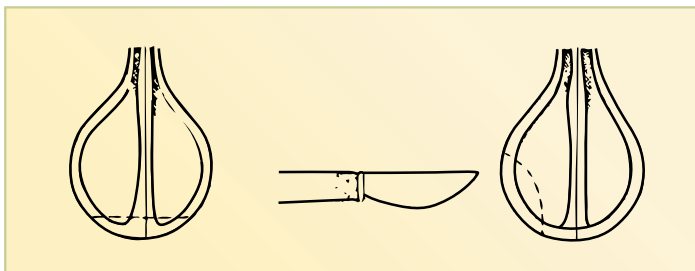
When properly done, surgical castration is quick and complete, allowing the animal to heal and resume growth after a few weeks.

Instruments used in castrating must be kept clean and disinfected thoroughly before each use. This prevents infected wounds. Operators should keep their hands clean and wear clean latex surgical gloves. Make sure the calf's genital area is clean and free of organic material, by washing the area with warm soapy water. Application of antiseptics to the calf's skin before castration is not useful unless the hair is shaved and the area scrubbed with soap several times. Cleanliness can be greatly aided by having available one or more buckets of warm water that contains a disinfectant to rinse off the instruments and the operator's hands. The instruments should also be allowed to soak in the bucket between animals. Consult with your veterinarian on specific disinfectants.

In an older calf, use a sharp knife or scalpel to make the cut along the side of the scrotum to expose the testicle (Figure 38). The cut should be one-third longer than the testicle and extend down to the tip of the scrotum. Free the testicle and the cord from the surrounding membranes by peeling the membranes back up the cord. If the animal is over six months of age, an emasculator may be used to sever the cord. The emasculator should be left on the cord for 30 seconds. Cut each side of the scrotum separately and then cut the cord for each testicle separately.



When the cord is cut in castration, infection can pass along the tube and cause peritonitis. This is a serious complication that can be prevented by using clean instruments and keeping the animal clean after the operation. Separate the cord by scraping the cord in a shaving motion. Cutting the cord down near the testicle, where it is thicker, causes more bleeding and leaves a large amount of clotted blood and tubules in the bag. Blood is an ideal medium for bacterial growth, which can result in infection. Cutting the cord up higher causes less bleeding, but if the animal does bleed, finding the bleeding cord later is much more difficult. Sometimes parts of the membranous bag or cord will hang from the wound. These parts should be removed to encourage healing and prevent infection.



**FIGURE 38.** Positions of surgical incisions

Immediately after castration, confine the animal in a well-bedded area or clean pasture for cleanliness, and keep the animal quiet for three to four hours to allow the bleeding to stop. Consider treating the animal with a long-acting antibiotic and keep it under close observation for five days to watch for swelling or stiffness from infection. Fly sprays may be needed if insects become a problem.

If the wound swells or the animal becomes stiff and depressed, isolate the animal immediately and call a veterinarian. The wound should be bathed with hot water and antibiotics should be administered. The veterinarian may open and drain the wound.

One of the major criticisms of surgical castration is the lack of use of anesthesia or analgesia for cattle. In Britain, castration is not permitted after eight weeks of age unless anesthesia is used. However, in North America, animals may be castrated without anesthetic as late as eight to nine months old when they reach the feedlot. The administration of local and general

anesthetics reduces the stress response but does not appear to eliminate it. A study conducted in 1992 by Faulkner et al. indicated that the administration of butorphanol and xylazine did not reduce stress in knife-castrated calves over controls. Fisher et al. (1996) conducted a study that compared surgical and Burdizzo methods (see below) done with and without local anesthetic. Surgical castration was found to be more stressful than Burdizzo castration. Local anesthetic reduced the cortisol response of surgical castrates, but was less effective for Burdizzo castrates. One reason that the effectiveness of anesthesia is questioned is that the handling and restraint required for the administration of the anesthetic can be just as distressing as the castration procedure itself, especially in calves less than two months old.

## Bloodless Castration

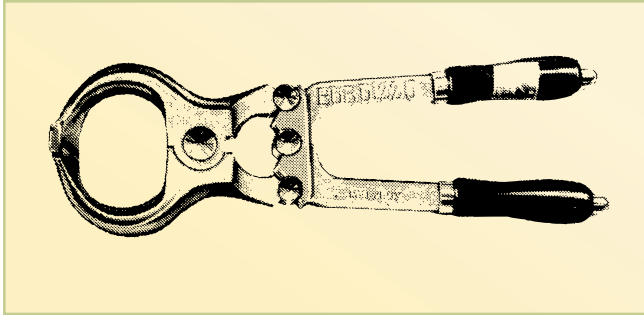
Bloodless castration refers to non-surgical castration. Currently, it is accomplished by using a rubber ring (an elastic band) or a Burdizzo, although research is being done to develop a vaccine for this purpose. Rubber rings should not be used on calves older than one month of age.

**Burdizzo castration:** Bloodless castration using a Burdizzo (Figure 39) involves crushing the cord and blood vessels that supply each testicle. Hold one testicle with its cord against the outer side of the scrotum. Apply the Burdizzo clamp high on the cord (Figure 40). Close the clamp and leave it in position for about one minute. By crushing the blood and nerve supply to the testicle, the Burdizzo causes sufficient impairment to result in a shrunken, non-functional testicle. Ensure the penis is not included in the crushed tissues. Repeat the operation for the second testicle.

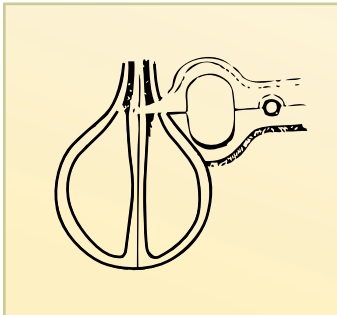
*Using a burdizzo to castrate a calf.*







**FIGURE 39.** Bloodless castrator - Burdizzo emasculator



**FIGURE 40.** Correct position of emasculator

**Immuno-castration:** A less invasive alternative known as immuno-castration is currently being developed. The research involves the production of a vaccine that targets the hormones responsible for sexual characteristics

and sperm production. So far, none of the vaccines provides the possibility of long-term castration.

## Dehorning

A suckling calf will have horn buds about 1 to 2.5 cm (0.3 to 1.0 in.) in length. No matter what instrument is used for dehorning, it must be cleaned and soaked in a disinfectant prior to its use and between uses on calves.

The most commonly used instrument for dehorning at this age is the gouger. When used properly, the gouger scoops out the horn button along with a ring of skin around the base of the horn that is about 6 mm (0.2 in.) wide. Be ready to cauterize the bleeding vessels as the gouger is very sharp and makes a clean cut. Clotting is more difficult when a clean cut is made.

## Implanting

Growth implants have been commonly used for a number of years to increase the rate of growth or gain for nursing calves, weaned calves and feedlot cattle. Implants consistently increase

growth rates by five to 23 per cent and improve feed conversion efficiencies by four to 11 per cent. The improved performance can provide an extra return of \$5 to \$10 for each dollar spent for the growth implant.

Table 25 lists implants registered in Canada as of 2000 for nursing beef calves. When deciding which implant to buy, consider the amount of additional gain the implant can give and the time period in which the implant has to work. The duration of effect after being implanted varies according to the brand and type of implant used. Each implant has a specific time that it is effective (e.g. between 60 and 120 days). Depending on the time between implanting and weaning, your choice of implants may change. Discuss the most appropriate implant to use on your calves with your veterinarian or livestock advisor. For more information on the use of implants in weaned calves and feedlot cattle, refer to the *Feed Additives and Growth Promotants* section in the *Nutrition and Feeding Management* chapter.

If you are considering or are involved in organic beef production or a natural beef production value chain, then do not use implants. For either of these programs, follow the guidelines established by the program that you are involved in. However, remember that not using implants contributes to increased production costs as the rate of daily gain is slower and feed efficiency decreases.

## How Growth Implants Work

Growth implants for beef cattle are tiny pellets, usually 2 mm (0.07 in.) in diameter. The one exception is Compudose®, which is a flexible cylinder about 30 mm (1.2 in.) long and 5 mm (0.2 in.) in diameter.

Implants are inserted, with a specially designed hypodermic needle, between the skin and cartilage of the ear. The ear is used because it is not part of the food system, so there is no risk of the highly concentrated pellet being found in meat. Once implanted, the active ingredients are slowly released into the animal's bloodstream. This increases the blood hormone level just enough to stimulate additional growth. At this level the animal's system directs more of the feed energy consumed toward the production of lean muscle

TABLE 25. Growth implants registered for use in Canadian nursing beef calves

Registered products	Active ingredients	Effective time (days)	Nursing calves	Calves intended to be breeding cattle	
				Bulls	Heifers
<b>Ralgro®</b> Ralgro	36 mg Zeranol	60 - 80	Yes	No	>30 days to weaning
<b>Synovex®</b> Synovex-C	100 mg Pr + 10 mg EB	~120	Yes	No	>45 days to <186 kg (410 lb.)
<b>Component®</b> Component E-C	100 mg Pr + 10 mg EB	~120	Yes	No	>45 days to <186 kg (410 lb.)
<b>Compudose®</b>	24 mg E17β	~ 168	Steers >79 kg (175 lb.)	No	No

Abbreviations: E17β - Estradiol (E)-17beta (β), the active form of Estradiol; EB - Estradiol benzoate (activity = 72% the activity of E17β); Pr - Progesterone; Zeranol has one-third the anabolic activity of E17β.

Source: Dorin (2000)

and away from additional fat production. This repartitioning of energy toward muscle from fat production is sometimes called an anabolic effect. As a result implanted animals grow faster, have leaner carcasses at a given weight and make more efficient use of the feed that they consume.

## Implanting Procedures

### SANITATION

Because the implant procedure produces a break in the skin, it is very important to maintain careful sanitary precautions. The needle of the implant device should be kept sharp and stored in a disinfectant solution between uses. It is best to clean the implant site on the ear with a disinfectant solution, especially if the ear is fouled with dirt or manure. There have been cases where an implant site has become infected and the implant was expelled or walled off in the abscess process. The benefit of the implant was lost and the infection probably reduced normal expected gains.

### IMPLANTING SITE

Insert the implant between the skin and the cartilage at the back of the ear. The proper location for all implants registered for use in Canada is now in the middle third of the ear (Figure 41).



Using an implant gun.

### IMPLANTING TECHNIQUE

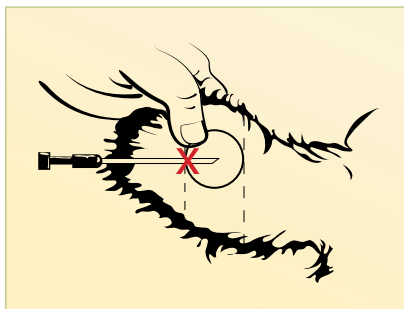
Proper insertion of the implant pellet(s) is the key to successful use of growth implants. The needle must be sharp. A dull or burred needle is difficult to use and can cause tissue damage, which may lead to infection at the implant site.

The proper angle of insertion is very important. The needle should be placed almost parallel to the ear with the bevel side away from the ear. Too steep an angle may result in the pellets being placed in the cartilage itself, where absorption is slow, or the needle may penetrate through the ear, where the pellets will be lost and wasted.

Select the injection location to avoid the major cartilage ridges and blood vessels in the ear (Figure 41). A pellet placed next to a broken blood vessel will soften and also be absorbed too rapidly.

Insert the needle at the X in the diagram (Figure 41) to the full length of the needle between

the skin and the cartilage. The needle is then withdrawn about 1 cm (0.5 in.), and then the pellets are forced into the ear as the needle is slowly withdrawn completely. This provides a space for the implant while avoiding the danger of crushing the pellets. Crushed pellets are absorbed too rapidly and are often associated with riding behaviour in newly implanted cattle.



**FIGURE 41.** Implanting site

improves sanitation and helps to avoid infection and loss of the implanted pellets.

Properly implanted pellets feel like tiny peas in a pod under the skin of the ear. When the needle is withdrawn, gently pinch the insertion site to close it. This

## WITHDRAWAL TIMES

Withdrawal time is the time needed between administering a drug or implant and the elimination of the drug or implant from the animal's tissues in order to ensure no residues remain in the animal's system when the animal's products (e.g. meat or milk) are consumed by humans. Since October 1990, all growth implant products used for beef production are registered for zero withdrawal time. However, implant strategies should take slaughter time into account to take full economic advantage of the implant.

## IMPROVED GAINS, FEED EFFICIENCY, AND ECONOMICS

Alberta field and feedlot trials, as well as those in the rest of Canada and the United States, have shown that growth implants can increase average daily gains and improve feed efficiency. As a result, the cost per pound of gain is reduced. Alberta trials conducted with yearling cattle showed increased weight gains of 9 to 23 kg (20 to 50 lb.) over the weight gains of their non-implanted pen mates. Economic partial budgets show that the cost of production can be reduced \$5 to \$10 or more for each dollar spent to implant feeder cattle.

Suckling calves that are given a single implant in the spring can usually be expected to gain 4 to 9 kg (10 to 20 lb.) more than untreated calves. In both calves and yearlings, growth implants are likely to give the greatest response if the animals are on a diet that allows for reasonable weight gain. A shortage of milk or forage, caused by drought, or a deficiency of any essential nutrient in the diet, reduces an animal's ability to realize its maximum potential for growth.

## Other Considerations and Precautions

### IMPLANTING BULL CALVES

Implants should not be used on bull calves intended for breeding purposes. Several studies have shown that testicle growth is reduced by at least 25 per cent in bull calves implanted from birth to 90 days of age. Producers have also reported that bull calves implanted at birth are much more difficult to castrate because of abnormal testicle growth.

However, if the bull calves are intended for slaughter, implants usually reduce bulliness and make the bulls more docile. Implanted bulls also exhibit increased weight gains. Be aware that implanted bull calves destined for slaughter receive bull discounts if sold in conventional marketing ways. Be sure to make the necessary arrangements with buyers before you choose this alternative to castration.

### IMPLANTING HEIFERS TO BE USED FOR REPLACEMENTS

With the exception of Synovex-C® and Component E-C®, used for suckling calves, growth implants are not registered for use in heifers intended for breeding stock. A review of 16 research studies showed that, in most cases, a single implant had very little effect on conception in heifers during the first exposure cycle. Implanted heifers often had increased pelvic areas at breeding, but by calving time there was little difference between implanted and non-implanted heifers. Lighter weight and younger implanted heifers exhibited a delay in age at first estrus, but heifers that had been fed to heavier weights had little difference in age at puberty. An Alberta study also showed

that implanted heifers had increased pelvic area at breeding, with no difference at calving time and no difference in calving difficulty. Pregnancy rates in the Alberta study were slightly lower in implanted heifers (91.6 per cent vs. 97.6 per cent). Overall pregnancy rates were acceptable, however, and Synovex-C® did not appear to have a marked detrimental effect on fertility later in the heifer's productive life.

### REIMPLANTING AND TIMING IMPLANTS

The various implants have different payout periods or effective times (Table 25). If the expected feeding period is longer than the payout period, most feeders will re-implant, often with a different product. Most implants release their contents at a reducing rate as they near the end of their payout period. In some cases the second implant is used when the payout period for the first is not completely finished.

### IMPACT OF IMPLANTS ON OUR FOOD SUPPLY

Considerable controversy exists relating to the use of hormonal implants and subsequent food safety. Concern exists that implanting hormones is not natural to the normal metabolism of the animal and that the hormone levels are higher in the meat at the food counter. Before any of the implants receive registration for use in Canada,

the company developing the product must do tests to determine the product's safety. This is standard protocol for any product that eventually is intended for human use.

The registered implants are thoroughly tested for safety to both the beef animal and the consumers of beef. Beef carcasses are thoroughly screened for the presence of implanted hormone residues. In nearly 30,000 carcasses sampled from 1990 to 1996, none of the meat samples showed residues that exceeded the very conservative maximum residue levels set by the United Nations Food and Agriculture Organization and the United States Food and Drug Administration.

Numerous research papers have reported data on hormone levels measured in tissues from non-implanted and implanted cattle. Naturally occurring hormone levels in tissue from non-implanted cattle vary with the sex, age, and breed of cattle, and whether the animals have been castrated or are pregnant. Hormone levels in meat are also affected by fat content, and concentrations of some hormones are significantly higher in the liver and kidneys than in muscle tissue. Maximum safe tissue residue levels (Table 26) have been established for trenbolone and zeranol, and acceptable residue levels above those normally present (Table 27) have been established for estradiol, progesterone and testosterone (Doyle 2000). Acceptable daily intake (ADI) maximums

TABLE 26. Maximum safe tissue residue levels for growth implants

Hormone	Residues in muscle (micrograms/kilogram) (µg/kg)	Residues in liver (µg/kg)	Residues in kidney (µg/kg)	Residues in fat (µg/kg)
Trenbolone	50	100	150	200
Zeranol	150	300	450	600

Note: µg/kg = ppb (parts per billion)

TABLE 27. Maximum safe residue levels for naturally produced hormones\*

Hormone	Residues in muscle (µg/kg)	Residues in liver (µg/kg)	Residues in kidney (µg/kg)	Residues in fat (µg/kg)
Estradiol	0.12	0.48	0.36	0.24
Progesterone	3.0	12	9	6
Testosterone	0.64	2.6	1.9	1.3

\*Levels include naturally occurring hormones plus growth implants.



for estradiol, progesterone and testosterone have been established at 0.05, 30 and 2 micrograms/kilogram ( $\mu\text{g}/\text{kg}$ ) of body weight (BW), respectively, based on reported no- or lowest-observed effect levels in humans of 5  $\mu\text{g}/\text{kg}$  (Doyle 2000). ADI values for zeranol and trenbolone acetate were set at 0.5 and 0.02  $\mu\text{g}/\text{kg}$  BW based on feeding experiments with monkeys and pigs.

As noted earlier, the growth implants now registered for beef cattle in Canada can increase growth, improve feed conversion efficiency and provide an extra return of \$5 to \$10 for each dollar spent for the growth implants. Implants also result in leaner carcasses at any given age or weight. Thus they benefit both the producer and consumer of beef.

## Creep Feeding

Summer pasture provides the least expensive feed for cows and calves. With the supplementation of phosphorus and trace mineralized salt, a cow on good pasture can usually meet her nutritional requirements for optimum milk production. Calves on milk plus good pasture should gain 0.6 to 1.4 kg (1.5 to 3.0 lb.) per day, depending on the milk production capability of the dam and the quality of pasture.

However, there are times where the amount of milk and pasture are not enough for the calf to grow to its genetic potential. In those situations (Table 28), calves can be supplemented with additional feed in such a fashion that only the calves can access the feed and the cows are excluded. Making the calves creep into the feed areas accomplishes this. The cows cannot gain access because of their size.

Creep feeding may be economically advantageous if one or more of the following situations exist:

- there are periods of drought when pastures are poor or when milk production of cows is lowered
- two-year-old heifers and low-producing cows and their calves can be separated from the main herd
- it is part of a forage management program to conserve pasture



*A creep feeding station on pasture.*

- there is a need to increase the pasture stocking rate
- calves are fall born
- as part of a pre-weaning program, creep feeding for two to three weeks before weaning will help accustom calves to dry feed
- prices for weaned calves are high and feed grain prices are low
- the market demands calves to be in extra good condition
- late calves are being pushed for a set market date
- there is a need to feed potential replacement heifers from low milk producers in order to get calves to reach puberty by 13 to 15 months of age
- there are large crossbred calves from low milk producing cows

The advantages of creep feeding are:

- calf weaning weights can be increased, ranging from 2.5 to 45 kg (5 to 100 lb.), with an average of 18 kg (40 lb.)
- pasture stocking rates can be increased
- pasture can be conserved
- calves can become accustomed to grain feeding so that they wean easier
- calves can grow to a more uniform size
- calves have less shrinkage at weaning time

The disadvantages of creep feeding are:

- creep-fed calves may use little pasture
- intake of creep feed can be variable
- feed efficiency is poor under certain conditions
- extra gain is usually lost in the feedlot; non-creep-fed calves show compensatory gain
- creep feeding puts unwanted finish on calves
- cattle buyers discriminate against extra fleshing
- cow productivity is decreased if the cow has been too fat as a calf

Many different creep feeds are available. The best creep feed is the one that meets the calf's

nutrient requirements, is least expensive and is palatable. Creep feeds should contain varying amounts of protein, energy, calcium, phosphorus and trace minerals designed to supplement the existing forage in the pasture.

In cases where pasture is available but the quality has declined due to maturity, a protein-based creep feed is in order (Table 28). In that situation, the calf needs to get the majority of its energy from grazing the pasture but needs a protein supplement to continue the digestion process and maintain overall consumption. In cases where the pasture is no longer available because of drought hindering regrowth or because of overstocking, an energy-based creep is more in order (Table 28). In that situation, the creep feed must provide both the protein and the energy needs of the calf. In both cases, the combination of the grazed feed and the supplemented feed

TABLE 28. Use factors for different classes of creep feeds

Energy creeps	Protein creeps	Green creeps
<ul style="list-style-type: none"> <li>• Fed when forage supplies are limited.</li> <li>• Usually grain-based (13 to 16% protein) with cracked oats and barley supplemented with pelleted 32% beef supplement or canola meal.</li> <li>• Most economical when intake is limited to less than 1.6 kg (3.5 lb.) per day.</li> <li>• Can be limit-fed with about 10 to 15% coarse white salt.</li> <li>• Feed conversion ranges from 2 to 14:1 kg creep/kg gain (4:1 to 30:1 lb. creep/lb. gain) with 4:1 to 5:1 kg creep/kg gain (8:1 to 10:1 lb. creep/lb. gain) being common.</li> </ul>	<ul style="list-style-type: none"> <li>• Fed when forage is available but lacking in protein content.</li> <li>• Contain a high percentage of protein such as in a 50:50 mixture of canola/soybean meal (41%), or pea meal (21%).</li> <li>• Most economical when intake is limited to 0.5 kg (1 lb.) per day.</li> <li>• Can be limit-fed with salt (10 to 15%).</li> <li>• Pelleting may be required to prevent separation of the creep ration ingredients.</li> <li>• Feed conversion under these circumstances ranges from 1:1 to 1.3:1 kg creep/kg gain (2.25:1 to 2.8:1 lb. creep/lb. gain).</li> </ul>	<ul style="list-style-type: none"> <li>• High quality pastures grown solely for grazing by nursing calves.</li> <li>• Plant small acreages [e.g. 4 ha (10 ac.)] of high quality forage next to pastures grazed by cow-calf pairs. Calves are then allowed access to the creep pastures through creep gates. In rotational grazing systems, calves can be allowed into the next paddock ahead of the cows.</li> </ul>

TABLE 29. Examples of creep rations

Feed ingredient	Percentage of ingredients in ration			
	Ration with 13% crude protein		Ration with 16% crude protein	
Oats	27.0	27.0	23.0	23.0
Barley	63.0	61.6	53.0	53.2
32% supplement	10.0	--	24.0	--
Canola meal	--	9.1	--	22.0
2:1 mineral	--	0.6	--	--
Limestone	--	1.2	--	1.3
Trace mineral salt	--	0.4	--	0.4
Vitamin ADE premix	--	0.1	--	0.1
<b>Total (%)</b>	100.0	100.0	100.0	100.0

must provide a balance of protein and energy to accomplish healthy growth. Another choice to supply energy and protein to grazing calves is to use a green creep (Table 28). The advantage of the green creep is that no mixing of feeds is required.

If protein or energy is lacking, calf performance is either retarded or the calves get too fat. Consult with a qualified nutritionist on selecting a creep feed mixture to meet the nutrient needs of the calf and yet be price competitive.

Creep feed can be purchased or it can be mixed at home using home-grown grains plus supplements. Table 29 provides examples of creep rations that can be formulated using either a commercial 32 per cent protein supplement or canola meal to provide energy and protein.

Young calves start to nibble at grain as early as three weeks of age, so you should encourage this tendency if you think you will be creep feeding later in the season. Calves started on a grain-based starter ration near birth will have a functioning rumen by eight to 10 weeks of age. Creep-fed calves with access to the feed starting at six weeks will consume up to 227 kg (500 lb.) and may weigh up to 27 kg (60 lb.) more at weaning time than non-creep-fed calves. These weight variances also depend on pasture availability, genetic potential for growth and the mother's milking ability. The cost of the feed, equipment and labour compared with the increased value of the heavier calf determines whether or not creep feeding pays.

## Weaning and Preconditioning

### Weaning Management

The main goal of a weaning program is to separate the calves from their mothers and to get them established on their own as easily and efficiently as possible.

**When to wean:** Calves should be old enough to use feed sources other than milk to gain weight. When not started on a grain-based starter ration near birth, the calf's rumen is normally functioning at 120 days of age and is able to provide enough nutrients for the calf to achieve satisfactory gains without milk or milk replacements. The actual time of weaning should be when the cow's milk declines and the calf's gain begins to decrease in response to milk availability. Traditionally, calves are weaned around 210 days or seven months of age, with a weaning range of six to eight months of age.

**Feed:** A successful weaning program encourages calves to begin eating supplemental feed quickly. Some producers introduce the calves to bunk feeding before actual separation of cows and calves. Others wait to bunk break the calves after weaning. The important point is that the sooner the calves



*This calf needs to be weaned.*

begin to eat supplemental feed, the more successful the weaning process. Supplemental feeds can be grains, protein supplements or hays. For detailed starter ration requirements, refer to the *Nutrition and Feeding Management* chapter. Supply the calves with good quality feed after weaning. Provide good quality, long grass hay during the first four to seven days after weaning, as calves may not easily adjust to silage, chopped hay or pellet rations.

**Water:** Fresh, clean water is also essential for calves. If they have not been accustomed to drinking from a trough before weaning, let the water run for a brief time and overflow the trough or watering bowls. This will attract the calves to the water to drink.

**Reducing weaning stress:** Calves all undergo weaning stress, but the level of stress varies. Stress is caused by removing calves from the cow, introducing them to new feeds, transporting them on trucks or putting them in a new feed pen environment. Stress reduces the immune function and leaves the calves vulnerable to sickness.

In general, to reduce stress, wean in good weather, handle the calves in a slow, quiet manner and avoid dusty situations that may aggravate respiratory diseases.

Various options exist to reduce the stress at weaning time. Although all of these options require fine-tuning management and some extra labour, they pay off in heavier, healthier calves, lower treatment costs, and/or better value in the marketplace. Options to consider include:

- conditioning the calves several days prior to weaning by introducing them to their new feeds and water source in their feeding pen while they are still with the cow
- pre-immunizing calves three to six weeks prior to weaning
- dehorning and castrating calves at birth or shortly after birth
- removing the calves from the cows but placing them in a good quality pasture where they can still maintain fenceline contact with their mothers for seven days.

Price et al. (2003) showed that providing fenceline contact between beef calves and their mothers for seven days following weaning reduced distress behavioural indices (e.g. calves cried less, spent less time walking the fence and spent more time eating) seen in totally separated calves. Fenceline contact with dams at weaning also minimized losses in weight gain in the days following separation. Totally separated calves did not compensate for those early losses in weight gain even 10 weeks after weaning (Price et al. 2003). If you use this option, move the cows to a good quality pasture away from the calves after seven days, so the cows can gain body condition before winter.



Recommended weaning procedures include:

- castrating and dehorning as early in the calf's life as possible
- vaccinating the calves with appropriate vaccines two to three weeks prior to weaning
  - proper vaccination technique is important for best antibody coverage of calves
  - assure proper care of vaccines and use only according to the label directions
  - maintain complete records of vaccinations and treatments as part of a total record of the calf's health program
  - avoid injecting into the hip or loin muscles. inject vaccines into the neck area
- treating for both internal and external parasites, preferably not at weaning time – treatment for warbles and lice can be done later in the fall, but before winter starts
- starting the calves on feed two to three weeks prior to weaning to get the calves adjusted to dry feed
- moving the cows and calves to the weaning pen two to three days before weaning
  - during this time the calves adapt to the pens, feeders and waters before weaning
  - the calves receive creep feed, but the cows are not fed
    - ◆ this reduces the cows' milk and increases the consumption of the dry ration by calves
  - at weaning, remove the cows from the pens, leaving the calves behind.
- aiming for a calf weight gain of 0.5 to 1 kg (1.5 to 2.5 lb.) per day during the weaning period, depending on type, size, sex and market needs
  - rations need not be complicated or expensive.

- all that is necessary is grain supplemented with a protein supplement, minerals and vitamins, and good quality forage (refer to the management of Backgrounding Programs in the *Nutrition and Feeding Management* chapter for more details)
- weaning at least 45 days prior to selling or shipping the calves
  - this adjustment time should result in healthier calves and better gains over the weaning period

## Preconditioning

Preconditioning is a management program to reduce the economic losses caused by stress and disease during the movement of calves from the cow herd to the feedlot. Preconditioning before selling allows you to:

- add value to your calves as opposed to selling raw product directly off of the cow
- increase calf weight by 20 to 30 kg (40 to 60 lb.) or more
- lower the shrink on the calves while they are being transported to the market or feedlot
- reduce feedlot sickness and death losses by over 50 per cent

The sound management practices used to precondition calves before weaning include:

- adapting the calf to the feedlot environment in an animal-friendly manner prior to shipment
- reducing disease by spreading the stress factors over a longer period so that the effects are not compounded by the calf's low resistance
- increasing disease resistance by vaccinating the calves before they come in contact with these diseases

# Summary

During pregnancy, provide the proper nutrients in sufficient quantities for the maintenance of the cow and the growth of her unborn calf. Avoid over- or underfeeding pregnant cows because being too thin or over-fat at calving time can cause calving problems.

Various problems can occur during and immediately after calving. You need to know when to intervene, and you need to know when to call a more experienced neighbour or your veterinarian. If you decide to provide assistance, be clean and gentle. Don't pull unless there are three parts of the calf in the birth canal. If distinct progress is not obvious within 10 or 20 minutes, call your veterinarian.

Normally, a calf goes through a series of steps as it becomes established in the world. The first steps end when the calf has nursed and taken its first nap. After that, any of the important parts of the calf's life are a repeat. In most cases the calf is able to work its way through those first steps on its own, with little assistance from its mother. You should intervene if the calf is not breathing within 10 to 15 seconds after birth, if it is shivering to the point of becoming numb or if it has not started sucking vigorously on the cow's teat within two or three hours of birth.

After the calf has nursed and is on its feet, there are several procedures to consider doing while the calf is young and easy to handle, including disinfecting the calf's navel, providing identification, castrating and dehorning.

Suckling calves should be vaccinated for the common diseases in your area. If the calves have not been castrated and dehorned as newborns, these procedures should be done as soon as possible on the suckling calves. Suckling calves may also be implanted with growth implants. Growth implants can increase growth, improve feed conversion efficiency and produce a leaner carcass. Sometimes the amount of milk and pasture is not enough for the calf to grow to its genetic potential. In those situations, creep feeding can give the calves access to the necessary nutrients while excluding the cows.

Various options are available for weaning programs to allow the calf to become established on its own as soon as possible. A key element is to reduce the stress on the calf. Preconditioning or vaccinating before weaning can reduce the economic losses caused by stress and disease during the movement of calves from the cow herd to the feedlot.



## Nutrition and Feeding

# Management

Feed costs are a major part of the total production cost in a cow-calf operation. These costs often go unnoticed when animals are out on pasture. In the winter, however, feed costs become obvious. The winter-feeding period accounts for 40 to 60 per cent of total production costs. In the summer period, body condition can be replaced on the cow at a lower cost.

This chapter first discusses nutrients that are essential for cattle and the nutrient content of different feedstuffs. It then discusses feeding and grazing management spanning the seasons, with suggestions that cover production, gestation and breeding.

Although the winter-feeding period is generally more critical, proper nutrition is also important in the grazing season. Your feeding program needs to provide adequate nutrition to the cow and calf at all stages of growth and in all seasons, while keeping an eye on feed costs. Inadequate nutrition at anytime of the year results in lowered reproductive performance in the herd, either immediately or at a later date. This lowered performance is reflected in the number of calves born and the interval between calvings.

The winter months make up most of the gestation period for the herd. Proper feeding during the gestation period and between calving and breeding is essential for good reproductive performance and calf productivity. Producers must provide enough feed and adequate nutrient levels to meet the herd's requirements without providing so much feed that production costs are uneconomical. The best approach is to provide a balanced ration that gives each class of cattle sufficient nutrients to promote optimum efficiency in performance at a reasonable cost. For example, alfalfa hay meets and exceeds the requirements of the herd, but a balanced ration of straw, grain and peas does too, and at considerably less cost.

For good nutrition in the grazing season, pasture management needs to integrate forage and grazing management with livestock nutrient requirements. Forage management considerations include the seeding and establishment of forage plants, fertilizer management and weed control. Having both perennial and annual pastures, with options to extend the grazing season, helps create a flexible grazing system. Grazing management considerations include the number and class of cattle, as well as the distribution, timing, frequency and selectivity of grazing. Good pasture management meets livestock production goals while maintaining productive pastures with desirable, healthy forage plants.

## Nutrients and Nutrient Needs

A nutrient is any substance necessary to perform the functions of maintenance, growth, production or reproduction. The term may refer to a single chemical element such as calcium or phosphorus, or a compound such as glucose or a group of substances such as carbohydrates or a complex group of substances such as glycoproteins.

Adequate nutrition means providing the animal with specific levels of the nutrients required for maintenance, growth, production

and reproduction. These nutrients include energy, protein, minerals, vitamins and water. The knowledge of these nutrients, including their functions and interactions and the effects of excesses and deficiencies, is key to proper feeding of animals.

The level at which each nutrient is required by an animal depends on the biological stage of the animal. The stages include: maintenance, pregnancy, lactation, growth and development. Nutrient needs depend on whether the animal is being fed for: maintenance; maintenance plus growth; maintenance plus growth and pregnancy; or, maintenance plus lactation.

Most nutrients when fed in excess of maintenance requirements contribute to increased performance. However, if any nutrient is not present in an adequate amount, the performance of the animal is limited. This principle is known as the first limiting nutrient. In the example shown in Figure 42, five nutrients are supplied in amounts adequate for a daily gain of 1 kg (2.2 lb.) or more. However, energy is supplied at a level adequate for a daily gain of about 0.5 kg (1.0 lb.). The animal on this ration will achieve a daily gain of about 0.5 kg (1.0 lb.). So in this example, performance is determined by the first limiting nutrient, energy. If the energy level were increased to the level of the other nutrients, the animal's gain would increase to 1.0 kg (2.2 lb.).

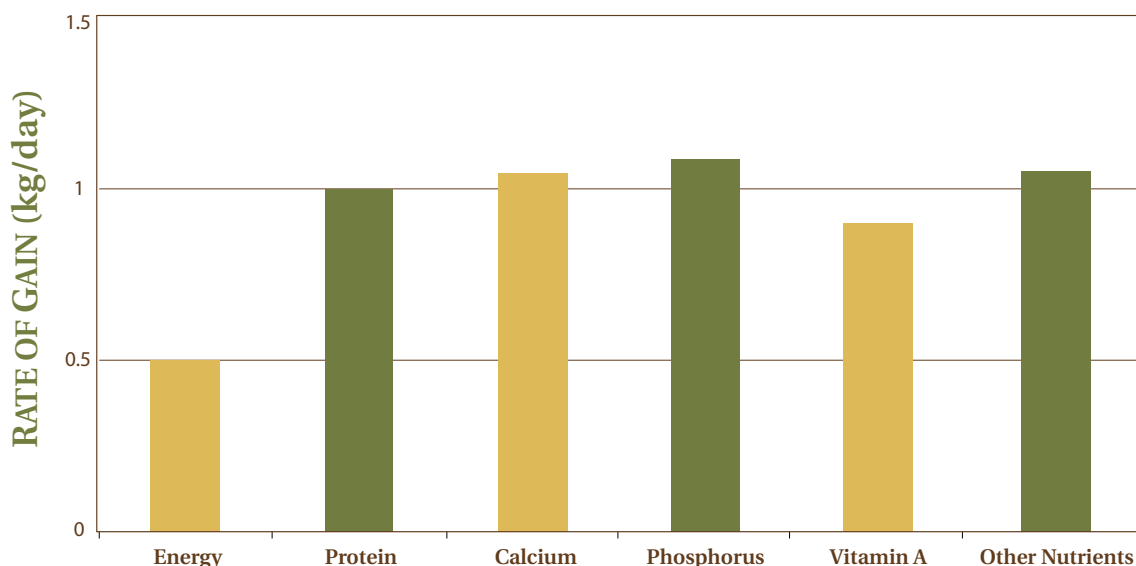


FIGURE 42. Principle of the first limiting nutrient



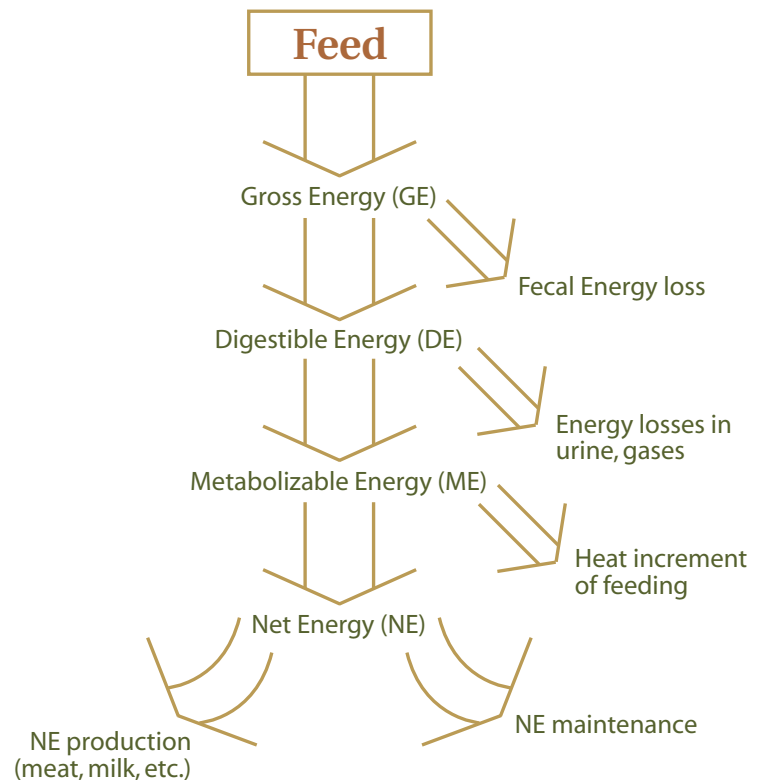
## Energy

Energy is defined as the ability to do work. It is measured in calories, kilocalories or megacalories. It is the fuel that an animal burns to maintain the body functions such as movement, heat production in winter and other productive purposes. The majority (75 per cent) of energy used in cattle production is for maintenance. Energy is usually the most expensive and most limiting nutrient in a ration.

Cattle are ruminants. All ruminants have a digestive system with four stomachs. Ruminants obtain energy primarily from the fibre, protein, carbohydrate and fat portions of a ration. Carbohydrates and fibre are fermented in the rumen, the first stomach. During this fermentation, rumen micro-organisms increase in number, and volatile fatty acids (acetic, propionic and butyric) are formed. These volatile fatty acids constitute the major source of energy for the ruminant.

The energy content of feed can be calculated and expressed in a number of different forms. It is most often calculated for beef cattle as a unit of heat expressed in megacalories (Mcal). Other expressions of energy content include: gross or total energy (GE), digestible energy (DE), metabolizable energy (ME) and net energy (NE). The relationships between these different forms are illustrated in Figure 43.

**Digestible energy (DE)** is the gross intake energy (GE), minus the fecal energy ( $DE = GE - \text{fecal energy}$ ). It gives an indication of the actual amount of energy that the animal has available for use. It is still the most popular way of expressing energy requirements of cattle. However, it only partially accounts for energy losses in the process of the utilization of nutrients. It also tends to over-value low quality feeds relative to high quality feeds.



**FIGURE 43.** The partition of energy

The concept of **total digestible nutrients (TDN)** comes from the old system of measuring available energy of feeds and energy requirements of animals involving a complex formula of measured nutrients. It is very hard to measure, but is used widely in some parts of the United States and Canada. Total digestible nutrient values are usually quoted as percentages for feeds and as amounts per day for requirements. The values are usually calculated on feed analysis reports. The simplest and most commonly used formula for estimating total digestible nutrients is:  
 $TDN = DE/0.044$ .

**Metabolizable energy (ME)** is the digestible energy (DE) intake minus the energy in the urine minus the energy in the gaseous product of digestion:  $ME = DE - (\text{energy in urine}) - (\text{energy in gaseous product of digestion})$ . The metabolizable energy value of individual feeds is rarely measured. Measuring the amounts of energy lost in gaseous form and in the urine is more difficult than measuring digestible energy. Therefore, conversion formulas are often used by nutritionists when ME values are needed. The common formula used to estimate metabolizable energy (ME) in beef feedstuffs is:  $ME = 0.82 \times DE$ .

**Net energy (NE)** is metabolizable energy minus the heat increment of feeding:  $NE = ME - (\text{heat increment of feeding})$ . The heat increment of feeding is the heat produced when feed is ingested and utilized. The net energy system divides energy requirements into net energy for maintenance (NEm) and net energy for growth (NEg) or net energy for lactation (NEl) in milking cows.

The net energy system is more accurate than these other systems because it gives the net value of each feed after accounting for all the energy losses in the process of feed and nutrient utilization. However, most published net energy (NE) values for feeds are not measured values but values converted from the digestible energy

(DE) system, so they are subject to the same errors in estimation of digestibility as the DE system. The net energy (NE) system is becoming increasingly popular for ration formulation. When formulating a diet, the net energy for maintenance (NEm) recommendation is met first and the net energy for gain (NEg) or net energy for lactation (NEl) supplied does not accumulate until the maintenance recommendation is met.

**Underfeeding energy:** A deficiency of energy caused by underfeeding is the most common nutritional problem in Alberta beef herds. It causes a reduction in or the stoppage of growth, loss of weight, reduced milk production, failure to conceive and increased mortality (often due to a lowered resistance to disease). Energy deficiencies are often complicated by deficiencies of protein or other nutrients.

Wiltbank (1970) demonstrated the effects of an energy deficiency on the reproductive performance of mature beef cows. He showed that an energy deficiency during the last trimester of pregnancy can slow down the return of estrus (cows are slow to show heat after calving), and that an energy deficiency from calving to breeding can lower conception rates (Table 30).

TABLE 30. Effect of energy deficiency on reproductive performance of beef cows

Feed energy level before calving to after calving*	Number of cows	Average daily weight change after calving kg (lb.)	Cows showing heat (%)		Cows conceiving after first service (%)	Cows pregnant (%)
			at 60 days after calving	at 90 days after calving		
Low - Low	18	-0.18 (-0.40)	17	22	33	20
Low - High	19	+0.05 (+0.13)	45	85	65	95
High - Low	21	-0.26 (-0.59)	81	86	42	77
High - High	20	-0.04 (-0.09)	80	80	67	95

\*Note: Approximately 21 Mcal of DE/day is normally required prior to calving and 27 Mcal of DE/day is required after calving.  
Source: Wiltbank (1970)

**Overfeeding energy:** Supplying too much energy is wasteful and increases feed costs unnecessarily. It can also adversely affect reproductive performance by causing calving problems due to increased fat deposition around the reproductive tract. This reduces the area of the pelvic opening.

## Energy Value of Forage

The energy value of forage depends on the species and its maturity. As forage matures, the level of fibre increases and the energy content decreases. The voluntary intake of forage also decreases as the forage matures (Table 31). When comparing hay that is cut early to hay that is cut late, remember that the late-cut hay has less energy per kilogram and will be consumed at lower levels. Thus, animals fed poor quality hay on a free-choice basis may not consume enough energy to meet their requirements. Legumes are usually higher in energy than grasses when they are cut at similar stages of maturity. Straws are comparatively high in fibre and low in energy.

TABLE 31. Feeding values of forages as influenced by stage of growth at harvest

Growth stage of hay when cut	Digestible energy Mcal/kg (Mcal/lb.)	Crude protein (%)		Intake (% of body weight)
		Grass	Legume	
Vegetative	2.77 (1.26)	15	21	3.0
Boot or bud	2.51 (1.14)	11	16	2.5
Bloom	2.20 (1.00)	7	11	2.0
Mature	1.94 (0.88)	4	7	1.5

Grains are concentrated sources of energy and are valuable as energy sources or supplements. Grains vary somewhat in energy content. Bushel weight is a reasonably good criterion with which to compare grains on an energy basis. For example, 1 kg (2.2 lb.) of barley with a bushel weight of 16 kg (36 lb.) contains about 93 per cent of the digestible energy in 1 kg of barley with a bushel weight of 22 kg (46 lb.). The difference in energy on a weight basis might be considered as minimal, but the difference on a volume basis is great.

## Protein

Proteins are composed of amino acids, which are nitrogen-containing compounds. Muscle, skin, hair, hooves and many other tissues and fluids in the animal's body contain protein.

The protein content of forage depends on the species and its maturity. Protein levels in roughages decrease as the forage matures (Table 31). Green, leafy roughages contain more protein than mature roughages, and legumes contain higher levels of protein than grasses. The protein content in grain, straw or aftermath (chaff) varies with the geographical area, level of nitrogen in the soil, fertilizer rates and weather conditions.

In the rumen, about 80 per cent of the protein in the feed is broken down to ammonia, carbon dioxide, volatile fatty acids and other carbon compounds by the microbes. The microbes then use the ammonia to synthesize their own body protein. As feed is passed through the rumen into the rest of the digestive tract, the micro-organisms containing about 65 per cent high quality protein are washed along too. The ruminant obtains most of its required protein by digesting these micro-organisms.

This process of breakdown and re-synthesis of protein in the rumen allows the ruminant to make use of non-protein nitrogen sources such as urea. Such compounds can be broken down to ammonia and carbon dioxide (as is whole protein) and used by the microbes to build their own body protein. If there is sufficient energy in carbohydrate form in the feed to allow this reaction to take place, ruminants are able to use non-protein nitrogen sources nearly as efficiently as a conventional, good quality protein source such as soybean meal. In the absence of carbohydrates, products like urea are broken down, but the ammonia is not captured. Instead, it passes through the digestive tract and is not used at all.

A portion of the protein fed to the animal passes through the rumen without being degraded to ammonia and carbon compounds. This protein is available for digestion and absorption in the small intestine. This portion of the protein is commonly called bypass protein or rumen undegradable intake protein (UIP). Protein that is degradable in the rumen is called degradable intake protein (DIP). Most classes of beef cattle can meet their needs for protein from the microbial protein produced in the rumen, and digested and absorbed in the small intestine. However, cattle with high protein needs may require some bypass protein, in addition to the microbial protein, to meet their needs. These cattle may include rapidly growing young calves and superior milk producing

cows. Most feedstuffs produce some bypass protein. The amount depends on the kind of feedstuff and the physical or chemical treatments that the feedstuff has received.

The concept of protein degradability has led to a new protein system called the metabolizable protein (MP) system. In this system, you balance to meet the requirements of the microbes and the animal, paying attention to the degradable (DIP) and undegradable (UIP) intake protein fractions of the feed. Table 32 shows estimates of the proportions of degradable and undegradable intake protein in some common Alberta feedstuffs. Work is ongoing at the University of Saskatchewan to verify the degradable and undegradable intake protein content of western Canadian feedstuffs.

TABLE 32. Degradable (DIP) and undegradable (UIP) protein content of some common feeds in Alberta

Feedstuff	Dry matter (%)	Crude protein <sup>1</sup> (%)	DIP <sup>2</sup> (% of crude protein)	UIP <sup>2</sup> (% of crude protein)
Alfalfa silage (mid bloom)	38	17	91	9
Alfalfa silage (full bloom)	40	16	91	9
Barley silage	39	11.9	86	14
Barley straw	91	4.4	30	70
Barley grain	88	13	67	33
Oat grain	89	11	80	20
Oat greenfeed	91	9.5	68	32
Timothy hay	89	8.8	70	30
Brome hay	89	10.6	77	23
Orchard grass hay	89	12.9	70	30
Alfalfa hay	89	18.2	81	19
Alfalfa-grass hay	89	14.0	77	23
Alfalfa pellets	90	17.3	54	46
Wheat grain	90	14.2	80	20
Canola meal	90	15.6	68	32

1 Crude protein is on dry basis.

2 Adapted from: CowBytes® (1999) Beef Ration Balancer program, version 4



The primary symptom of a protein deficiency is a depressed appetite. Because reduced feed intake can cause an inadequate energy intake, protein deficiencies are often accompanied by energy deficiencies. Symptoms of protein deficiency and the resulting energy deficiency are an irregular or delayed estrus (heat) in breeding females, loss of weight, slow growth and/or reduced milk production.

Inadequate protein intake by beef cows and heifers in the before-calving period (prepartum period) and the after-calving period (postpartum) has been shown to result in lower pregnancy rates (58 per cent on average) in comparison with cows and heifers receiving adequate protein intake diets (90 per cent). As noted above, diets with insufficient energy can reduce first-service conception rates. Inadequate protein levels for beef cows and heifers also suppress first-service conception rates (25 per cent rate as compared to 71 per cent rate for those with adequate protein levels) (Sasser et al. 1989). When protein and/or energy levels are inadequate, the combination of suppressed fertility and extended postpartum interval are combined, final pregnancy rates are lowered. Monitoring the pregnancy rate and the number of cows and heifers that calve in the first 21 days of the calving period can provide you with an indicator that the energy and protein levels should be checked in the herd's diet.

Most cattlemen manage their replacement heifers to calve as two-year-olds. The majority of the reproductive problems within a herd occur in these younger cattle. A higher plane of nutrition (energy and protein) is required for the younger cow to continue her growth, produce a healthy calf and rebreed early in the breeding season. If the whole herd were fed for the needs of the younger cow, then the mature cows would be overfed. If you feed to meet the needs of the mature cows, then the younger cows will lose body condition, have lower pregnancy rates and have longer postpartum intervals. Feeding the first-calf and second-calf cows separately from the mature cow herd will allow you to manage both groups for the best reproduction potential and save money by not overfeeding any of the herd.

## Minerals

A number of inorganic elements (minerals) are essential for normal growth and reproduction in animals. Beef cattle require at least 17 essential minerals in varying amounts. They can be divided into two groups: macro-minerals, and micro-minerals.

Macro-minerals, also called major minerals, are required in gram (g) quantities, if the animal is to live and function. Macro-minerals perform specific roles in the body's structure and functions. The following seven macro-minerals are essential to animals (the mineral names are followed by their chemical symbols):

- Calcium (Ca)
- Phosphorus (P)
- Sodium (Na)
- Magnesium (Mg)
- Potassium (K)
- Sulphur (S)
- Chlorine (Cl)

Table 33 shows the average levels of several of these minerals in some common feeds produced in Alberta. Look at the averages, but most importantly note the wide variability as indicated by the ranges.

*A mineral feeder.*



TABLE 33. Average major mineral analyses of selected Alberta-grown feedstuffs

Feedstuff		Calcium (%)	Phosphorus (%)	Magnesium (%)	Potassium (%)	Sulphur (%)
Alfalfa hay	Average Range	1.71 1.08 to 3.04	0.21 0.07 to 0.36	0.31	1.74	0.23
Grass legume hay	Average Range	1.13 0.14 to 2.72	0.19 0.04 to 0.35	0.24	1.57	0.16
Grass hay	Average Range	0.53 0.11 to 1.0	0.17 0.04 to 0.36	0.17	1.20	0.18
Oat greenfeed	Average Range	0.32 0.08 to 1.02	0.20 0.03 to 0.40	0.39	1.81	0.18
Barley grain	Average Range	0.07 0.02 to 0.12	0.38 0.22 to 0.53	0.14	0.54	0.13

**Micro-minerals**, also called trace minerals, are required in milligram (mg) or microgram ( $\mu\text{g}$ ) amounts. They are found in animal tissues and feeds in very low concentrations. They often serve as components of enzyme cofactors or hormones. Essential trace minerals include:

- Copper (Cu)
- Manganese (Mn)
- Zinc (Zn)
- Selenium (Se)
- Iodine (I)
- Cobalt (Co)
- Iron (Fe)
- Molybdenum (Mo)
- Nickel (Ni)
- Chromium (Cr)

Many of the macro- and micro-minerals normally occur in sufficient quantities in feeds. Others must be supplemented in the ruminant ration. Recommended feeding levels are discussed in the following sections.

The following elements can also be found in minute amounts in the tissues of animals:

- Aluminum (Al)
- Arsenic (As)
- Tin (Sn)
- Fluorine (F)
- Silicon (Si)
- Vanadium (V)

Data on the requirements of cattle for these elements are limited or non-existent. Practical diets would not be expected to result in deficiency of any of these elements.

Several minerals that are not usually required by cattle can cause toxicity when fed above the levels listed in Table 34. Feeding toxic levels of these minerals for a short period of time may not produce ill effects in cattle, but prolonged feeding will. Symptoms of toxicity vary in severity from marked hindrance and death to slight impairment of growth, reproduction, milk production or other body functions.

TABLE 34. Maximum tolerable concentrations of some mineral elements toxic to cattle

Element	Maximum tolerable concentration (mg/kg)
Aluminum	1,000.00
Arsenic	50.0 (100.0 for organic forms)
Bromine	200.0
Cadmium	0.5
Fluorine	40.0 to 100.0
Lead	30.0
Mercury	2.0
Strontium	2,000.0

Source: National Research Council (2000, 1996)

## Macro-minerals

### CALCIUM (CA)

Most of the animal's calcium is found in the skeleton where it forms the bone matrix to allow for the rigidity of the body, protection of soft tissues and attachment for the muscles. The body also needs calcium for blood clotting, nerve and muscle control, acid-base balance and producing milk.

Calcium is found in most feeds. Table 33 shows the average calcium levels in some common Alberta feedstuffs. Hays, especially legume hays, contain high levels of calcium. On the other hand, grains contain very low levels of calcium. Other sources of calcium include mineral supplements such as bone meal, ground limestone, dicalcium phosphate and defluorinated rock phosphate.

Calcium is an important mineral in ruminant nutrition, and a calcium supplement should be fed to cattle if grain, greenfeed or straw is the major feedstuff in the ration. The maximum calcium content in a daily ration is 1.0 per cent of dry matter intake (DMI).

In ruminants, calcium deficiencies often occur when animals are fed high-grain rations without proper calcium supplementation. A calcium deficiency can cause rickets in young animals and osteomalacia in mature animals. Rickets is a nutritional disease where the bones fail to

harden properly. The bones bend or break easily and the disease causes stiffness in the animal. Osteomalacia is a condition that results from the withdrawal of calcium from the bones in a period of deficiency. It causes bones to break easily and milk production levels to decline.

The ability of the animal's body to use calcium is influenced by the levels of various other minerals in the body. High levels of phosphorus or low levels of vitamin D may cause symptoms of calcium deficiency because they prevent proper use of calcium in the animal's body. Calcium levels are also affected by potassium and magnesium levels.

In mature cows, low calcium levels may result in milk fever near calving or after calving. Milk fever occurs as the formation of colostrum draws a high level of calcium from the blood serum. Acute hypocalcemia (milk fever) is observed when the serum calcium level falls rapidly from the normal concentration, which lies within the range of 2.2 to 2.6 mmol/L (Allen and Sansom 1993). About 2.5 g (0.09 oz.) of calcium are extracted from blood for each kilogram of colostrum produced. So a beef cow that produces 5.0 kg (11 lb.) of colostrum uses about 12.5 g (0.45 oz.) of calcium. The calcium lost from the plasma pool must be replaced either by increasing intestinal calcium absorption or increasing bone resorption, or both (Horst et al. 1997).

Signs of milk fever include general muscular weakness and twitching, circulatory collapse, subnormal temperature, increased heart rate, laying on one's chest and loss of consciousness. During the early stages of this disease, cows show signs of hypersensitivity and excitability, slight unsteadiness on their feet, muscular tremors and general restlessness; very similar to the signs of tetany. In the later stages of milk fever cows can die. However, unlike death from tetany, there are no signs of paddling or struggling on the ground around the cow's head and legs. (For more information, see the *Calcium:Phosphorus Ratio* section in this chapter or the *Milk Fever* section in the *Animal Health Management* chapter). The incidence of milk fever increases with the age and parity of the cow. It is very rare for milk fever to occur in heifers, but by the sixth lactation as many as 20 per cent of cows will experience the disease (Allen and Sansom 1993).

## PHOSPHORUS (P)

Phosphorus, like calcium, is found mainly in the bones of the animal's body. Phosphorus is also used in the metabolism of energy, in the acid-base balance and in the body's enzyme systems. Phosphorus functions in bone and cell membrane structures and in genetic, energy, enzyme and blood buffering systems.

Phosphorus absorption involves both active transport and diffusion systems. Over 90 per cent of phosphorus can be absorbed on phosphorus-deficient diets. However, the availability of supplemental phosphorus is rather low, about 15 to 20 per cent. If present, fatty acids and aluminium ions can form complexes with phosphorus in the gut and decrease phosphorus absorption.

Proper utilization of phosphorus depends on an adequate supply of vitamin D. Excesses of calcium increase the requirement for phosphorus. Phosphorus toxicity can occur when calcium and magnesium phosphates precipitate in the urine (the cause is urinary calculi).

A phosphorus deficiency is characterized by poor reproductive performance, as seen by irregular estrus (heat cycle) and reduced fertility. Phosphorus deficiency can also be evidenced by stiffness in the hindquarters, easily broken bones, rickets or pica (a depraved appetite where animals chew and eat rocks, dirt, wood, bones, etc.). Phosphorus is important for young calves as it plays a role in growth of bones.

Research conducted by Call et al. (1978) showed that feeding heifers diets containing 0.14 or 0.36 per cent P for two years resulted in no differences between the two groups. No differences in growth, rib bone morphology and phosphorus content, age at puberty, conception rate or calving interval were detected. In a second study, Hereford heifers were fed low-phosphorus diets from weaning through their fifth gestation and lactation (Call et al. 1986). The low-phosphorus group received 6 to 12.1 g (0.43 oz.) of phosphorus/day, while controls received 20.6 to 38.1 g (1.3 oz.) of phosphorus/day with phosphorus intake increased as the cattle grew larger. Females fed the low-phosphorus intake remained healthy, and growth

and reproduction were similar to those observed in the supplemented animals. When phosphorus intake of 6 to 12.1 g (0.43 oz.) of phosphorus/day was reduced to 5.1 g (0.18 oz.) of phosphorus/day, clinical signs of deficiency occurred within six months (Call et al. 1986). Reproduction was not impaired until cows were fed the very low phosphorus diet for more than one year. It was concluded that 12 g (0.42 oz.) of phosphorus/day throughout one production year was adequate for a 450 kg (990 lb.) Hereford cow. No measurements of milk production or calf weaning weights were given in these papers.

There is considerable variation in the phosphorus content in forages and concentrates fed to cattle. Table 33 lists the average level of phosphorus in Alberta-grown feedstuffs, but also notice the range from lows of 0.03 per cent to highs of 0.53 per cent. Generally, phosphorus levels in grains are relatively high, while levels in roughages are normally lower. About two-thirds or more of phosphorus in cereal grains, oilseed meals and grain by-products (e.g. grain screening pellets) is bound organically in phytate. Although, phytate-bound phosphorus is poorly available to pigs and chickens, it is readily digested by cattle. Cereal grain, grain byproducts and canola meal are excellent sources of phosphorus. Supplemental inorganic phosphorus sources are bone meal, dicalcium phosphate and defluorinated rock phosphate.

It is important to remember that the amount of phosphorus required by cows increases dramatically after calving. A considerable amount of phosphorus is used to produce milk. As a result, the phosphorus requirement of heavier milking cows is higher than that of average producing cows. To estimate the cow's phosphorus requirement, a good rule of thumb is to adjust the requirement by 2 g/45 kg (2 g/100 lb.) of change in cow body weight and 1.0 g/kg (0.5 g/lb.) of milk change.

Although cattle may receive sufficient phosphorus when fed high-grain diets, it is best to have all home-grown feed sources tested for mineral content because of the large range in actual phosphorus content in different forages and grains fed to beef animals. Once you know the phosphorus and calcium content of your farm's main feedstuffs, estimate the amount of each feed stuff being



consumed, and either by hand or by using a ration balancing program such as CowBytes®, determine the amount of supplemental mineral required for your breeding herd.

Phosphorus is the most expensive macro-mineral element in mineral supplements. The most practical and economical method of supplying phosphorus is to make sure supplemental phosphorus is fed from 40 to 60 days pre-calving through at least half of the breeding season.

### **CALCIUM:PHOSPHORUS RATIO**

An imbalance in the levels of calcium and phosphorus can be as bad as a deficiency of either mineral. Too much phosphorus can tie up the calcium present and cause a calcium deficiency. It may also tie up other minerals (such as magnesium) present in the feed or mineral supplement. Too much calcium can lower the availability of phosphorus and cause an apparent phosphorus deficiency.

For ruminants, the calcium to phosphorus ratio should be between 1.5:1 and 7:1. Some recent information suggests that a calcium to phosphorus ratio of 1.75:1 to 2:1 may be necessary for cattle on high-grain rations to make the best use of the starch in grain. Too little calcium can cause the pH of the small intestine to be too low for optimum digestion and absorption of starch.

### **Calcium-phosphorus mineral supplements**

The type of mineral supplement to use depends on the feedstuffs consumed by the cattle. The maximum phosphorus content of a diet is 0.6 per cent of the dry matter intake.

Cattle on a legume forage diet should be supplemented with a mineral mixture containing equal amounts of calcium and phosphorus, and at least 14 per cent phosphorus. This type of mineral is commonly referred to as a 1:1 mineral (equal parts calcium and phosphorus). Minerals containing phosphorus but no calcium can also be used with legumes. However, these minerals are generally less palatable than 1:1 minerals, so you may want to consider an alternative mineral blend or one that has flavour added.

Cattle grazing mainly grass pasture or receiving either hay or silage should be supplemented with a mineral mixture containing about twice as much calcium as phosphorus and at least eight per cent phosphorus. This mineral type is commonly called a 2:1 mineral. However, a 1:1 mineral can also be used for cattle on a grass diet. Generally, 2:1 minerals are more palatable than 1:1 minerals, again due to the amount and taste of phosphorus. If cattle are fed cereal silage or greenfeed, or are grazing stubble aftermath, they should be supplemented with a 2:1 mineral.

Free-choice consumption of mineral supplements is often erratic. Studies show that cattle have little nutritional wisdom and usually fail to eat the proper mineral supplement in sufficient quantities to balance their diet. The exception to this observation is that cattle will likely consume enough salt, on a free-choice basis, to meet their needs. In fact, mixing salt with other mineral supplements usually increases palatability and improves overall mineral intake. A free-choice salt/mineral mixture should be 40 to 60 per cent mineral supplement in a loose form, and placed in a mineral feeder location that is convenient for the cattle if a significant level of supplementation is to be achieved. Even with these proportions of salt and mineral, there are definite limits to the amount of mineral supplementation that can be achieved with a free-choice system.

It is doubtful that cows will consume enough phosphorus on a free-choice basis to meet their needs after calving. It may be necessary to feed cows some grain with added minerals between calving and the time they move to good green pasture. The energy supplied by the grain also helps the cow meet her increased energy needs. If 2.5 kg (5.5 lb.) of grain is fed per head per day, include 10 kg (22 lb.) of a 1:1 mineral in each tonne of grain, assuming average milking cows are being fed. If superior milking cows are being fed, add 30 kg (66 lb.) of mineral in each tonne of grain. In addition to the salt/mineral mix, a fortified trace mineral salt should also be available free choice.

Mineral supplements may meet requirements for one mineral (phosphorus) with 15 g (0.52 oz.). However, the remaining trace minerals may require up to 100 g (3.5 oz.) of intake. Follow the feeding recommendations on the mineral tag. Also consider the stage of the animals that you are trying to supply with minerals, and the feedstuffs that you have available.

## MAGNESIUM (MG)

Magnesium plays a part in the cow's carbohydrate metabolism and enzyme systems involved in the transfer of energy. Magnesium is mostly present in bone and muscle, and is closely associated with calcium and phosphorus. Magnesium functions in nerve transmission, genetic material (DNA) formation, many enzyme reactions and amino acid metabolism. It is necessary for the utilization of energy in the body and for bone growth.

Absorption is dependent on magnesium (Mg) status of the animal, varying from 25 to 75 per cent of dietary intake. Absorption of Mg is influenced by the amount of calcium (Ca), phosphorus (P) and potassium (K) in the diet. Gestating cows require 0.12 per cent and lactating cows need 0.2 per cent magnesium. The maximum tolerable level is 0.40 per cent of dry matter intake.

Kemp and 't Hart (1957) observed that the ratio of potassium to the sum of calcium and magnesium in forage was significantly correlated to the incidence of tetany in grazing cows. The dietary tetany ratio of potassium to magnesium plus calcium [K:(Mg+Ca)], measured in milliequivalents per kg of dry matter, should not exceed 2.2:1 (Table 35). High dietary potassium (K) or sodium (Na) sulphate (S) or phosphorus (P) reduces absorption of magnesium.

Deficiency symptoms include grass or winter tetany. The precise causes of tetany are often difficult to ascertain. Feeds normally contain sufficient amounts of magnesium to meet an animal's requirements, but certain conditions can cause a lowered availability of magnesium. For example, animals placed on a lush green pasture may in some cases be affected by grass tetany, the most common type of magnesium deficiency.

Grass tetany is caused by a lowered availability of magnesium and not necessarily a dietary deficiency. The grass tetany condition usually occurs five to 10 days after cattle are turned out on pasture. It occurs most often in older cows and cows in their first two months of lactation. Tetany can also be a problem in winter or early spring, when cows are exposed to bad weather. The symptoms are unusual alertness (hyperexcitability) and nervousness, muscle twitching, staggering gait, falling and convulsions that may eventually lead to death. Less acute forms show up as a loss of appetite, decreased milk production, slight nervousness, stiffness in gait and muscle tremors.

Magnesium supplementation is difficult on pasture, unless grain is fed daily. The palatability of magnesium oxide is poor, so including magnesium supplements in free-choice mineral mixes is often ineffective.

Winter tetany is often seen in cows in late pregnancy or after calving. Winter tetany is a metabolic disease caused by lower than average blood magnesium levels. Winter tetany in Alberta is often associated with feeding grain, straw or greenfeed based rations. Especially in the early stages of the illness, affected cattle may look like those with milk fever. In the early stages, the affected animals may have depressed appetite, slight nervousness, muscle tremors, and spells of bellowing and frenzied movement. In acute cases, animals exhibit hyperexcitability, muscle spasms and staggering. As the symptoms progress the cow may lay on her chest and go into convulsions, resulting in the signs of struggling or paddling of the head and legs, before death occurs. Farmers sometimes refer to these animals as "downer cows." Producers should contact their veterinarian immediately if cattle show any of these symptoms. Treatment includes intravenous or subcutaneous administration of solutions containing magnesium and/or calcium salts.

Prevention of winter tetany is possible through supplementation of the ration with magnesium oxide and limestone. Calcium is also often deficient in cereal-based rations. Limestone is a good source of calcium. Supplementation programs should be designed to provide approximately 40 g (1.4 oz.) of magnesium oxide and 80 g (2.8 oz.)

of limestone per cow per day. Greater amounts may be required if the potassium level is extremely high. Magnesium oxide is very unpalatable and should be mixed with grain or screenings based supplements, or with silage, to achieve this level of intake. Producers should work with a nutritionist from a feed company to design a program that fits with their management system.

To help reduce the incidence of tetany in the herd, the goal should be to reduce the potassium (K) to calcium (Ca) + magnesium (Mg) ratio  $[K:(Mg+Ca)]$  to less than 2.2:1 and to get the calcium (Ca) to phosphorus (P) ratio to greater than 2 in the total ration. The dietary cation-anion balance (DCAB) calculation (available in the CowBytes® program) can be used as a guideline as well. Cereal-based rations also require supplementation of salt, trace minerals and vitamins, as well as protein if a lot of straw is used.

## POTASSIUM (K)

Potassium functions in the acid-base balance of the body, enzyme systems, glucose and amino acid uptake, and blood pressure regulation. Potassium, like sodium, serves to maintain proper acidity levels of the body fluids and the osmotic pressure in cells. It is also required for a number of enzyme reactions in carbohydrate metabolism and protein synthesis.

Absorption of potassium is mostly by passive means. Several hormones influence potassium levels in the body including antidiuretic hormone (increases), aldosterone (decreases), glucocorticoids (decreases), insulin (increases) and glucagon (increases).

Deficiency symptoms include abnormal electrical activity of the heart, slow growth, stiffness, convulsions and even death. Deficiency can occur in animals fed high-grain diets and during stressful situations.

A small increase in blood potassium can be toxic. As noted above, the dietary tetany ratio (potassium: magnesium + calcium  $[K:(Mg+Ca)]$ ) should not exceed 2.2:1. High dietary potassium reduces absorption of magnesium.

Forages normally contain more than adequate amounts of potassium. Supplemental potassium may be necessary for high-grain feedlot diets. Gestating cows need 0.6 per cent of dry matter intake (DMI) as potassium. Lactating cows need 0.7 per cent potassium. The maximum tolerable level is three per cent of DMI.

## Potassium:(magnesium + calcium) ratio (dietary tetany ratio)

The tetany ratio, potassium(K) :[magnesium (Mg) + calcium (Ca)]  $[K:(Mg + Ca)]$ , is calculated to assess the diet's potential to cause grass or winter tetany or for assessing suspect feeds after a problem has occurred (refer to the *Grass and Winter Tetany* section in the *Animal Health Management* chapter for details on clinical symptoms). The tetany ratio should not exceed 2.2:1. High dietary potassium or sodium sulphate or phosphorus reduces absorption of magnesium but increases calcium absorption from the intestine.

The tetany ratio is calculated by entering the percentage of potassium (K), calcium (Ca) and magnesium (Mg) in the diet into the equation  $[K/(Ca + Mg)]$ . The following example uses the sample data from Table 35:

$$K/(Ca + Mg) = 1.53/(0.68 + 0.22) = 1.7$$

TABLE 35. Example levels of potassium, calcium and magnesium from feed analysis

Nutrient	Per cent (%) of ration (dry matter basis)
Potassium (K)	1.53
Calcium (Ca)	0.68
Magnesium (Mg)	0.22

## **SODIUM (NA) AND CHLORINE (CL)**

These minerals are found together as common salt. They function in the acid-base and osmotic pressure balance in the body.

Sodium functions to regulate the movement of water into cells, osmotic pressure, transport of glutamine and glucose, the acid-base balance, nerve transmission and intracellular potassium concentration, and to maintain muscle tone. Most sodium in the diet is absorbed.

Deficiency symptoms include craving for salt, muscle cramps, tetanus, and reduced feed intake, growth and milk yield. Toxicity can occur when high sodium is fed with limited water. Symptoms include nervousness, muscle twitching, diarrhea and death.

Water is very variable in sodium content. High sodium content in water warrants special consideration in ration formulation. Sodium is 40 per cent of salt, so sodium content divided by 0.4 (or multiplied by 2.5) gives an approximation of salt available.

Sodium is needed at 0.06 to 0.08 per cent of diet for growing and finishing cattle or gestating cows, and at 0.1 per cent for lactating cows. Salt need is based on the sodium recommendation. Recommended salt values are 0.15 per cent, 0.15 per cent and 0.25 per cent for growing/finishing, gestating and lactating cattle, respectively. There is no reason for a salt deficiency to occur. Salt is relatively inexpensive and very palatable. Cattle will go looking for it if they do not get enough.

Salt can be fed either free-choice or as part of a ration. Under ordinary circumstances the use of salt licks or rations containing 0.25 per cent to 0.50 per cent salt is perfectly safe. Excessive salt consumption may occur if animals are offered loose salt after being without salt for a considerable length of time. One should avoid the use of salt control rations when animals have restricted access to water.

Excessive salt consumption may cause death by upsetting the tissue water balance by impairing the ability of the kidneys to remove excess water from the bloodstream. Symptoms include salivation, thirst, muscular spasms, scouring and prostration.

There is no chlorine (Cl) requirement for cattle. Chlorine also forms part of the digestive juices in the abomasum (final chamber of the complex stomach of ruminants). It functions to determine the acid level in the stomach (abomasal juice), the acid-base balance and the so-called chloride shift (the oxygen and carbon dioxide exchange in the red blood cells in the presence of carbonic anhydrase and which involves movement of the chloride ion). Absorption involves both active transport and diffusion systems. Chlorine is lost through urine and sweat. Deficiency symptoms include slow growth, but this deficiency is very rare.

## **SULPHUR (S)**

Sulphur is a component of protein, some vitamins and several important hormones. Sulphur is found in virtually every tissue and organ of the animal's body. It is an essential component of the amino acids found in protein methionine and cysteine. Sulphur is involved in the activation of various enzymes, protein synthesis and use, fat and carbohydrate utilization and breakdown, hormone systems, blood clotting and maintenance of the acid-base balance of body fluids.

Most absorption of sulphur occurs in the small intestine as part of amino acid sulphur. In the rumen, sulphur is used by the rumen microbes for their own growth. These microbes convert any inorganic sulphur in the diet to organic sulphur compounds that can be utilized by the animal.

Deficiency symptoms are very diverse due to the varied functions performed by sulphur. Severe sulphur deficiency results in anorexia, weight loss, weakness, dullness, emaciation, excessive salivation and death. Marginal deficiencies can reduce feed intake, digestibility and microbial protein synthesis. Sulphur toxicity can lead to polioencephalomalacia. Excess sulphur from either the diet or water interferes with copper availability. There is an interrelationship between copper, molybdenum and sulphur. High levels of sulphur and/or molybdenum tend to increase copper requirements for cattle.



Sulphur is required at 0.15 per cent of the diet for most cattle. Lactating beef cows require a higher level of 0.20 per cent sulphur in their diet. The maximum tolerable level is 0.40 per cent. Sulphur can be supplemented in cattle diets as sodium sulphate, ammonium sulphate, calcium sulphate, potassium sulphate, magnesium sulphate or elemental sulphur. Sulphur is present in all feeds, but feeds grown on grey wooded soils are commonly low in sulphur. Feeds higher in protein tend to contain more sulphur. Normal diets and supplements usually contain sulphur at reasonable levels.

### Micro-minerals

Trace minerals, or micro-minerals, are required in very small amounts, measured in milligrams or micrograms, to meet the animal's requirements. The term "trace mineral" came about when early nutritionists using analytical methods available at that time could not measure very small amounts of a mineral. Therefore, they would say that there was a "trace" of it present.

Some of the main terms and conversions related to trace minerals are:

- **parts per million (ppm):** For example, 10 ppm = 10 grams (g) in 1 million g, or 10 ppm = 10 mg in 1 million mg. So, if an animal requires 10 ppm of a trace mineral, then 10 g of the trace mineral would be required in 1 million grams of the diet.
- **parts per billion (ppb):** For example, 10 ppb = 10 mg in 1 billion mg, or 10 ppb = 10 g in 1 billion g. To convert ppb to ppm, divide by 1,000. For example, 400 ppb = 0.4 ppm.
- **milligrams per kilogram (mg/kg):** For example, 1,000 mg = 1 g; 1,000 g = 1 kg; 1 million mg = 1 kg.
- **per cent (%):** This, of course, is parts per hundred. To convert from per cent to mg/kg move the decimal four places to the right. For example, 0.03% = 300 mg/kg. To convert mg/kg to per cent move the decimal four places to the left. For example, 3,000 mg/kg = 0.3%.

The majority of feed analysis reports, feed tags, feed tables and animal requirements for trace minerals are given in mg/kg or ppm. Both mg/kg and ppm are the same since there are 1 million mg in 1 kg. For example, 10 mg/kg = 10 ppm.

### IODINE (I)

The minimum recommended level for iodine is 0.5 mg/kg of diet. The maximum tolerable level is 50 mg/kg. Absorption takes place throughout the gut and the rumen is the major absorption site. Excretion is mainly through urine, with small amounts in feces and sweat.

Iodine functions in the control of energy metabolism (oxygen consumption, body temperature), brain function, fat metabolism and weight loss, and conversion of carotene to vitamin A. The first sign of iodine deficiency is usually enlargement of the thyroid (goiter) in the newborn. Iodine deficiency may result in calves born hairless, weak or dead. Other symptoms include calves with reduced immune response and reduced growth performance. Symptoms in mature animals are reduced reproduction in cows characterized by irregular cycling, low conception rate, poor milk production and retained placenta. Bulls will have decreased libido and poor semen quality.

Chronic toxicity can result in reduced feed consumption, reduced milk yield, goitre, damage to the lining of the gut, increased number of premature births, still births, and weak and abnormal calves at birth. Acute toxicity signs are anorexia, excessive salivation, hyperthermia, coughing, nasal and ocular discharge, bronchopneumonia and abortions.

### COBALT (Co)

Cobalt is required in very small amounts, but is nonetheless essential in the rations of ruminants. The minimum recommended level for cobalt is 0.1 mg/kg of diet. Maximum tolerable level is 100 mg/kg. Absorption of cobalt from the ration is over 50 per cent and is dependent on an intrinsic factor (a natural regulator in the body), which protects cobalt from intestinal proteases (enzymes), heat and bacteria. Excretion is mainly through the bile.

Cobalt functions in the formation and utilization of some of the amino acids. Cobalt is required by the rumen microbes to produce the cobalamin molecule (vitamin B12). Vitamin B12 levels appear to be a better indicator of cobalt needs than are cobalt levels. If an animal is short of B12, it is probably due to a shortage of cobalt.

Deficiency symptoms are similar to energy-protein malnutrition or heavy parasitism. Symptoms include listlessness, anemia, loss of appetite, loss of condition, weakness, rough hair coat, reduced conception rates, delayed onset of puberty and estrous failure. At the beginning of cobalt deficiency, vitamin B12 levels fall first (the most serious indicator), followed by loss of appetite. Other symptoms appear after six months on a deficient diet. Phosphorus deficiency can cause similar signs.

Cobalt toxicity is very rare.

## SELENIUM (SE)

Selenium is deficient in some regions of the province and surplus in others, so it is important to know what the case is in your area.

Alkali disease or blind staggers occurs when cattle eat feed containing toxic or excess amounts of selenium (2 mg/kg) over a long period of time. Chronic toxicity results in loss of weight, dullness, sloughing of hooves and tail hair, lameness and death from respiratory failure. Toxicity is rare, but occasionally it is found where cattle on overgrazed pasture in the brown soil zone are forced to eat a milkvetch (*Astragalus* sp.) that accumulates selenium. Toxicity can also occur in cattle and calves that are over-supplemented and over-injected with selenium. The best cures are to remove the animal from the pasture or to blend winter feeds high in selenium with other feeds that are low in selenium, or to implement a low selenium mineral package.

Selenium deficiency may result in white muscle disease in calves. A vitamin E deficiency increases the amount of selenium required to prevent this form of nutritional muscular dystrophy. Cows on selenium-deficient diets may have reduced reproductive performance, lower fertility, increased incidence of retained placentas,

lameness, diarrhea, reduced immune response and poor body condition. The National Research Council daily requirement for selenium is 0.10 mg/kg (Table 36), but a more practical minimum level is 200 parts per billion (0.20 mg/kg). The maximum tolerable level is 2.0 mg/kg.

Selenium deficiencies have been observed in many parts of Alberta, especially in areas with grey wooded soils. If selenium deficiency is a problem, provide supplemental selenium in the ration. Supplemental selenium can be purchased in complete feeds as well as in salt, mineral or injectable forms. When injectable selenium is used, the injections are needed at monthly intervals. Selenium absorption in association with methionine and cysteine is almost 100 per cent, while inorganic sources are about 60 to 70 per cent efficient. Excretion occurs through the urine, bile and pancreatic juice.

It is useful to consult with a nutritionist or veterinarian if you suspect selenium problems, as there is a fine line between toxicity and deficiency. Selenium should never be supplemented without considering the whole nutrient package. Selenium and vitamin E perform related functions in the muscle. One can replace the other to an extent, but not completely (refer to the *Vitamin E* section in this chapter). Note that beef cattle and dairy cattle may receive only one source of supplemental selenium.

## IRON (FE)

Iron is an essential part of hemoglobin, a compound that carries oxygen in the blood. An iron deficiency may cause anemia and reduce growth. There is generally no need to supply extra iron as virtually all feeds in Alberta contain enough iron for cattle. The iron requirement is approximately 50 mg/kg of diet in beef cattle.

## ZINC (ZN)

Zinc affects growth rate, reproduction, skeletal development, skin condition and the utilization of protein, carbohydrates and fats in the body. Zinc functions as a component of over 200 enzymes, stabilizes cell membranes, binds proteins to membranes and controls gene transcription and immune function.

The classic symptom of a severe deficiency is a mange-like skin condition called parakeratosis. While this condition is rare in Alberta, the incidence of reduced growth rates as a result of low zinc levels appears to be increasing. Deficiency symptoms include loss of appetite, scaly skin, loss of hair, reduced immune function, vision impairment, excessive salivation, reduced growth rates and impaired reproduction.

Zinc has a minimum recommended level of 30 mg/kg for all cattle. The maximum tolerable level is 500 mg/kg of diet. Absorption occurs throughout the gut with efficiency up to 30 per cent. Dietary requirements are about 50 mg/kg. The average amount of zinc in Alberta forage samples is about 23 to 25 mg/kg. If supplementing zinc is required, it can be supplied in trace mineralized salt, mineral packages or protein supplements.

### **COPPER (CU)**

Copper functions in various enzyme systems. The daily requirement for copper is 10 mg/kg of diet for all cattle. The maximum level is 100 mg/kg of diet. It is absorbed in all parts of the gut, with high levels found in the liver and brain.

Copper absorption is affected by the levels of other nutrients. Sulphur reduces copper absorption. High levels of sulphate in drinking water may reduce copper absorption in cattle. High levels of molybdenum and sulphur will reduce copper availability. High levels of iron and zinc may also reduce copper utilization and may increase copper requirements.

A copper deficiency can result in anemia, depigmentation in hair, a rough hair coat, stunted growth, loss of condition, depraved appetite, infertility in cows, diarrhea and cardiac failure.

Most of the Alberta feeds tested for copper contained less than the daily requirement of 10 ppm. The incidence of copper deficiency is increasing. Copper can be supplemented with trace mineralized salts, mineral supplements or protein supplements.

### **MOLYBDENUM (MO)**

Molybdenum forms an essential part of some enzymes. It may also have a stimulating effect on fibre-digesting micro-organisms in the rumen. Molybdenum functions in enzyme cofactors such as sulphide oxidase (reduction of sulphates to sulphides) and in the metabolism of drugs and foreign compounds. Absorption is mainly in the abomasum and small intestine with efficiency up to 85 per cent. Excretion is mainly in urine and bile. Molybdenum absorption is reduced when intake of sulphate is high.

There is no molybdenum requirement for beef cattle. The maximum tolerable level is 5 mg/kg.

Molybdenum toxicity is characterized by diarrhea, anorexia, weight loss, stiffness and changes in hair colour. Excessive quantities of molybdenum interfere with the utilization of copper and may cause copper deficiency. Symptoms of secondary copper deficiency (molybdenum-induced) include rough or poor hair coat, faded colour (red turns yellow, black becomes brown), spectacles of faded hair around the eyes, severe scours and loss of body weight. Cows have reduced fertility, delayed puberty, low conception rates and low ovulation rates. Bulls have reduced semen quality. High sulphur levels can also interfere with Cu utilization, but molybdenum has a greater effect. High sulphur content in the diet or water supply can make a problem with excessive molybdenum more severe. The dietary copper (Cu):molybdenum (Mo) should ideally be greater than 6:1, with borderline toxicity at 2:1 to 3:1, and toxic if less than 2:1.

The few molybdenum analyses done on Alberta-grown feedstuffs indicate that molybdenum toxicity is not a major concern. The level of molybdenum in Alberta feeds varies. Molybdenum-induced copper deficiency does appear to be an increasing problem in Alberta.

## MANGANESE (MN)

Manganese is essential for the utilization of carbohydrates. Reproductive disorders in the adult cow are among the early symptoms of a deficiency. These disorders include silent heat, delayed or irregular estrus, reduced fertility, abortions, low birth weights and deformed calves. Calves born to manganese-deficient cows have deformed legs (over knuckling, enlarged joints, stiffness and twisted legs), weak and shortened bones, and poor growth. Toxicity may cause anemia due to blockage of iron absorption and loss of appetite.

Manganese has a minimum recommended level of 20 mg/kg of diet for growing cattle and 40 mg/kg for gestating and lactating cows. The maximum tolerable level is 1,000 mg/kg of diet. Absorption is through the gut but the efficiency of absorption is low (up to 25 per cent) with absorption rates highest for iron and higher for cobalt than manganese. Excretion of excess manganese is through the bile.

Manganese deficiency occasionally occurs within the province. Generally, manifestations of deficiency in ruminants are rare. Most of the forages analysed for manganese in recent years contained more than 40 ppm. However, feedstuffs grown in Alberta vary from well below required levels to well above. The concentration of manganese in forages varies greatly depending on plant species, soil pH and soil drainage (Minson 1990). Forages usually contain adequate manganese, corn silage can be low to marginal, cereal grains are between 5 and 50 mg/kg, and plant proteins (such as canola meal or soybean meal) normally contain 40 to 60 mg/kg. In spite of this variance in manganese levels, very few diagnoses of manganese deficiency have been made in Alberta. It is possible and may even be likely, that subclinical manganese deficiency is occurring and goes unrecognized.

## OTHER TRACE MINERALS

Chromium (Cr), tin (Sn) and nickel (Ni) appear to be present in sufficient quantities in Alberta feeds to meet the requirements of most farm animals.

Fluorine (Fl) is essential for proper bone development, but causes toxicity if fed at too high a rate. It is used in domestic water supplies to reduce the incidence of tooth decay. Too much fluorine causes abnormal bone growth, mottling and degeneration of teeth, and delayed growth and reproduction. To avoid excessive consumption of fluorine, be sure that rock phosphate feed is defluorinated.

## CHELATED TRACE MINERALS

Chelated minerals are a group of organic minerals that are actually classified as proteinate, chelates and other complexes, depending on the mineral's molecular structure. A chelated mineral is a mineral such as copper or zinc that is bonded by two or more chemical bonds with peptides (small protein molecules) or amino acids. Each has a varying level of absorption and efficacy.

There is serious debate among producers and scientists as to the effectiveness of chelated minerals. There may be times of year, environmental factors (iron in water, molybdenum in feed) or very high production goals that may warrant the use of these expensive minerals (often 2.5 times the cost of other minerals). Results seem to vary and may depend on the type of mineral used, intake levels and efficacy. Producers should evaluate whether chelated minerals have a place in their own operation.

## WHEN TO SUPPLEMENT WITH TRACE MINERALS

There is increasing evidence that parts of Alberta are experiencing serious production losses as a result of trace mineral deficiencies. These deficiencies are being recognized on land that has been farmed for many years, especially when high yielding crops are produced. The starting point of any mineral program is to balance to your herd's requirements based on forage analysis.



Most livestock specialists in Alberta now accept that routine trace mineral supplementation is well worth what it costs. Iodine and cobalt have been recognized as deficient in many parts of Alberta for many years. In the past 20 to 40 years, selenium deficiency has become a major problem in many parts of the province. Copper, manganese and zinc levels in feeds are commonly below published requirement levels for beef cattle. Improvements in animal health, growth and reproduction have often been observed when these trace minerals are given as supplements in the diet of beef cattle.

But remember that if you give your animals excess trace minerals, at best it makes for richer manure. At worst it causes reduced performance or even death. The maximum tolerable level of the elements listed in Table 34 and Table 36 may be substantially affected by specific feeding conditions. They are given here as a general indication of upper levels that may be tolerable.

TABLE 36. Mineral requirements and maximum tolerable concentrations for beef cattle

Mineral	Unit	Growing finishing cattle	Cows milking	Maximum tolerable concentration
Chromium	mg/kg	Not available	Not available	1,000.00
Cobalt	mg/kg	0.10	0.10	10.00
Copper	mg/kg	10.00	10.00	100.00
Iodine	mg/kg	0.50	0.50	50.00
Iron	mg/kg	50.00	50.00	1,000.00
Magnesium	%	0.10	0.20	0.40
Manganese	mg/kg	20.00	40.00	1,000.00
Molybdenum	mg/kg	Not available	Not available	5.00
Nickel	mg/kg	Not available	Not available	50.00
Potassium	%	0.60	0.70	3.00
Selenium	mg/kg	0.10	0.10	2.00
Sodium	%	0.06 - 0.08	0.10	-
Sulphur	%	0.15	0.15	0.40
Zinc	mg/kg	30.00	30.00	500.00

Source: National Research Council (2000, 1996)

A convenient and relatively inexpensive method of supplementing the commonly deficient trace minerals is to provide a trace mineralized salt on a free-choice basis all year long. Many different types of trace mineralized salts are available with or without selenium. For meaningful supplementation of most Alberta feeds, the formulation in Table 37 would meet most trace mineral requirements for a 590 kg (1,300 lb.) beef cow.

TABLE 37. Recommended trace mineral levels in salt for Alberta beef cattle

Mineral	Mineral level in salt (mg/kg)	Amount of mineral supplied when a beef cow consumes 45 g (1.6 oz.) of salt (mg/kg)	Per cent of 590 kg (1,300 lb.) beef cow's total daily requirements
Copper	2,000 - 4,000	90 - 180	65 - 130
Manganese	5,000 - 10,000	225 - 449	29 - 58
Zinc	5,000 - 12,000	225 - 539	42 - 100
Iodine	70 - 200	3.1 - 9.0	45 - 130
Cobalt	30 - 60	1.3 - 2.7	90 - 200
Selenium	25 <sup>1</sup> - 120 <sup>2</sup>	1.1 - 5.4	43 - 200

1 This amount is sufficient only to overcome borderline deficiencies.

2 The maximum allowable level of selenium in trace mineralized salts fed free-choice for all classes of beef cattle is 120 mg/kg.

Note: Beef cattle may receive only one source of supplemental selenium.

Although trace mineral supplementation is routinely recommended for beef cattle in Alberta, the importance of major nutrients such as energy, protein, calcium and phosphorus should not be forgotten. Deficiencies of these nutrients are much more common and costly to the producer than are trace mineral problems.

Care should always be taken to ensure that label directions are followed, especially for highly concentrated premixes of trace minerals. Remember that trace minerals are required in very minute amounts and that some trace minerals can be toxic at levels just 10 times higher than the required amounts.

## Vitamins

These organic compounds are required in minute amounts by the body. They are essential to metabolism and some must be supplied in the feed of ruminants. Vitamins are divided into two basic groups:

### Fat-soluble vitamins

- vitamin A
- vitamin D
- vitamin E
- vitamin K

### Water-soluble vitamins

- vitamin B1 (thiamine)
- vitamin B2 (riboflavin)
- niacin
- vitamin B6 (pyridoxine)
- pantothenic acid
- folic acid
- biotin
- choline
- vitamin B12
- vitamin C

Cattle normally require vitamins A, D and E. The rest of the vitamins (B vitamins, vitamin C and vitamin K) are produced by rumen micro-organisms in sufficient quantities so additional vitamin supplements are usually not beneficial (refer to the *Cobalt* section in this chapter for details on an exception).

Vitamins A, D and E, or their precursors, occur naturally in many feeds. In the summer months, when cattle are on fresh pasture, these vitamins are present in sufficient quantities so that synthetic supplements are not required. However, in the winter months it is advisable to use synthetic sources of these vitamins. The synthetic vitamins are relatively inexpensive safeguards against deficiencies. Also, the vitamin content in cured feeds may be very low or unavailable for use by the cattle.

## Vitamin A

Vitamin A is the most important vitamin in cattle nutrition. It is the only one that normally must be added to cattle diets. It is necessary for bone development, sight and maintenance of healthy epithelial (skin) tissues. A deficiency can cause an increased susceptibility to disease, night blindness and reproductive failure. Deficiency symptoms reflect the many functions of vitamin A. Toxicity results in bone abnormalities, loss of hair, poor growth and congenital abnormalities.

Vitamin A is a generic term and refers to all compounds, other than carotenoids, with vitamin A activity. Vitamin A is fat-soluble and is absorbed in the gut mainly as free retinol and carotenols. These compounds are converted to active vitamin A in the animal's body and are referred to as pro-vitamin A or precursors of vitamin A. A large number of these compounds exist in plant material, with beta carotene having the most vitamin A activity.

Light and oxygen can oxidize vitamin A, which destroys it. Usually over 90 per cent of vitamin A activity is retained for up to six months, but even under good storage conditions vitamin A activity declines during storage. Vitamin A is easily destroyed under adverse storage and feeding conditions, and in the presence of trace minerals.

Vitamin A activity is also reduced in the presence of trace minerals. Vitamin A is also reduced by heat (e.g. when feed is steam pelleted). For these reasons, most nutritionists do not rely on stored forages to provide the required vitamin A.

Vitamin A supplementation is usually not necessary for cattle grazing on green plants. Green plants contain substantial quantities of carotene and therefore supply large amounts of vitamin A activity. As plants mature the carotene content declines. Pastures or ranges that are over-mature and cured in the stand will likely have lost most of their vitamin A value. However, animals grazing on green grass can store vitamin A in the liver and draw on it for two to four months.

Sun-curing of forage reduces its carotene content since sunlight breaks down vitamin A. Thus hay and silage can vary considerably in carotene content. The average carotene value of alfalfa hay is 54.1 mg/kg (24.6 mg/lb.), but it ranges from 0.7 to 194.7 mg/kg (Cattle Nutrition Course). Carotenoids are broken down in the body to form vitamin A. Thus forages are analysed for carotenoids, rather than vitamin A. Carotenoids are measured in mg/kg or mg/lb., while vitamin A is measured in international units (IU). Cattle can convert 1 mg of carotene to 400 international units (IU) of vitamin A.

Vitamin A content of each feed is expressed in thousands of international units (KIU) per kg or lb. Recommended and supplied levels of vitamin A are expressed as IU. Prior to calving, beef cows require 40,000 to 50,000 IU of vitamin A per head per day.

Although Alberta forages may contain sufficient carotene to meet all requirements, it is good insurance to feed vitamin A because the carotene content of forage declines with sun-curing and with storage. Vitamin A is inexpensive. The dry granular product is the most economical source and may be fed daily, weekly or monthly. For example, beef cows may be fed a week's or even two weeks' supply of vitamins at one time, when it is not possible to feed supplements (e.g. during swath grazing) on a daily basis. Alternatively, animals may be injected with a two- to three-month supply. It should be injected twice during the winter before calving.

Water-soluble vitamin A is sometimes added to the stock water, but it is difficult to tell whether the animal is getting its daily or monthly quota this way. Many mineral and beef supplements also contain varying levels of vitamins. Most mineral supplements cannot routinely be relied upon to supply enough vitamin A. Check the label for the vitamin A concentration and calculate how much of the supplement needs to be consumed to meet the daily vitamin A requirements for livestock.

## Vitamin D

Vitamin D is called the sunshine vitamin because ultraviolet light acting on a compound in an animal's skin changes that compound into vitamin D. Vitamin D is found in sun cured forages. Animals kept outdoors or fed sun cured hay do not usually suffer a deficiency, whereas animals kept indoors and fed silage may do so.

Vitamin D is a fat-soluble vitamin required for calcium and phosphorus absorption. It also plays a role in the mobilization of calcium from bone and serves a role in the immune function of the body.

Because vitamin D is involved in the uptake of calcium and phosphorus, a vitamin D deficiency resembles a calcium and phosphorus deficiency. Symptoms of deficiency include rickets in calves, which happens when bone fails to mineralize adequately. Other symptoms are weak bones that are easily broken in older animals and decreased growth rates in calves. A vitamin D deficiency can also contribute to the occurrence of milk fever in cows. This may occur when the demand for calcium increases for colostrum production at calving time or for milk production shortly after calving. Deficiency symptoms also include loss of appetite, digestive disturbances, swollen and stiff joints, irritability, tetany and convulsions. Calves of vitamin D-deficient dams may be born dead, weak or deformed.

Toxicity symptoms include very high blood calcium levels as a result of increased bone resorption, leading to very soft bones.

The vitamin D requirement of cattle is 275 IU/kg of dry matter intake where one IU is defined as 0.025 µg (micrograms) of cholecalciferol D3.

However, cattle exposed to sunlight or fed sun-cured forages can synthesize vitamin D and usually don't need supplementation.

## Vitamin E

Vitamin E and selenium have similar and interrelated functions in the body. In practical terms, it is very difficult to distinguish between a selenium and vitamin E deficiency under field conditions. For example, white muscle disease (see the *Selenium* section) may respond to either selenium or vitamin E, or may require both.

Use supplements containing vitamins D and E in addition to vitamin A as they cost little to add. The recommended level of vitamin E is 15 IU/kg of dry matter intake for most classes of cattle, although higher amounts are needed during stressful periods (e.g. cows in late pregnancy, calves at weaning time). In conjunction with selenium, vitamin E plays a role in the immune function of cattle. Vitamin E functions as part of a multi-component antioxidant defence system. Thus, supplementing animals that are stressed or have poor immunity may improve their ability to fight off infection. The recommended level for cows during the last six weeks of pregnancy until the start of breeding is 200 IU/day. Supplementing animals with 200 to 500 IU/day may improve immune function and/or reduce stress. For stressed calves at weaning time, include 400 to 500 IU/day.

High levels of vitamin E can spare but not replace selenium because vitamin E is fat-soluble and protects the surface of the cell, while selenium acts within the cell. Vitamin E is generally considered one of the least toxic of the vitamins.

## Water

Water is an important nutrient for beef cattle. Water intake varies depending on the age of the animal, rate and composition of gain, lactation, activity, type of diet, feed intake and air temperature (Table 38). A restriction in water intake can greatly reduce feed intake, which results in lower production. For this reason, water should be available on a free-choice basis at all times. During winter, a mature cow will consume between 22 and 47 L (5 to 10 gal.) of water per day depending on temperature and stage of pregnancy.



TABLE 38. Approximate total daily water intake of beef cattle

Animal	Water intake (L) for various air temperatures (°C)*					
	4.4°C	10°C	14.4°C	21.1°C	26.6°C	32.2°C
Feeders and replacements 2 to 6 months old	20.1	22.0	25.0	29.5	33.7	48.1
Feeders and replacements 7 to 11 months old	23.0	25.7	29.9	34.8	40.1	56.8
Feeders and replacements 12 months and older	32.9	35.6	40.9	47.7	54.9	78.0
Bred heifers and dry cows	22.7	24.6	28.0	32.9	--	--
Lactating cows	43.1	47.7	54.9	64.0	67.8	61.3
Herd bulls	32.9	35.6	40.9	47.7	54.9	78.0

\* Note: For temperatures below 4.4°C, use the intake at 4.4°C. For temperatures above 32.2°C, use the intake at 32.2°C. Calculate intermediate values for intakes between the temperatures given in the table.

Source: National Research Council (2000, 1996)

## Water Quality

Water quality is also important to livestock so have your water analyzed for dissolved minerals. Minerals contained in water can be additive to the minerals contained in feeds. Stock water should be free from fecal contamination and algal toxins and contain less than 100 ppm of nitrates, as high nitrate levels can cause production problems. The highest level of sulphate recommended for cattle is 1,000 ppm. Higher concentrations can be tolerated, but there is a loss in productivity. This level of sulphate can induce copper, zinc, iron and/or manganese deficiency in cattle. Sulphate has an additive effect with chloride as a laxative, but sulphate has twice the effect of chloride. Young animals can tolerate a total dissolved salt content of not more than 7,000 ppm. Older cattle will tolerate up to 10,000 ppm.

By paying close attention to water quality, producers can expect all their livestock to have better gains and health. Since the bovine is very tolerant of poor quality water, obvious health concerns may not arise but subtle losses are occurring on a daily basis. In studies comparing water supplies from dugouts versus tanks, calves gained up to 20 per cent more weight over the summer when water quality and accessibility were improved.

Exposure to water-borne pathogens is also minimized by not allowing cattle to have direct access into a dugout. Manure with *E. coli* or coccidian oocysts is harmful, especially to young calves. Manure is high in phosphorus, which leads to algal blooms (discussed in the *Blue-green Algae Poisoning* section). Herd problems with footrot, leg injuries and drowning can also be eliminated with improvements to water access.

In order to maintain healthy dugouts it is important to have up to a two-year supply of water. Aeration, through the use of windmills, helps eliminate algal growth. Eliminating direct access to the water source helps stop unwanted contaminants from building up. Dugouts can be fenced off and the water can be pumped into

*Water quality affects performance and health.*



troughs using wind or solar power. Given the choice between an unfenced dugout and a better source of water, cattle usually select the better source. Shallow lines can be dug in to allow wells to supply pastures in different locations. These lines need to be blown out in the winter to prevent freezing. A single nose pump has the capacity to supply water for 30 cow-calf pairs. Minimizing access to riparian areas (areas along the edges of streams, rivers and lakes) also helps to protect the environment. For more information, refer to the *Pasture Water Quality* section in this chapter.

Water is the nutrient of life. Animals will only survive seven days without it. It pays to check water quality and ensure that disease is not introduced through this source.

### Snow as a Water Source

The University of Alberta has conducted several studies about using snow as a water source for cattle. Pregnant cows using snow as their only water source showed only a minimal difference in their calf's body mass, subcutaneous fat, birth weight or weaning weight. However, lactating cows and their calves need to have access to a fluid water source, as they often lose body weight while consuming snow.

Cattle unfamiliar with using snow as a water source will start to consume snow within one to three days. Cattle recover quickly from this adjustment.

Cattle prefer clean, soft snow, so snow is not a reliable water source if the snow is trampled, windblown or crusted. In chinook areas, a lack of snowfall and periodic melting make snow an unpredictable water source. Snow trapping may

*Cows can use snow as a water source.*



help meet the herd's water needs. It is essential that alternative methods of watering cattle are available if snow conditions or a lack of snow becomes a problem.

Whether deciding to use snow alone or a combination of snow and fresh water, producers need to monitor their animals closely to determine if their water needs are being met. Fresh water needs to be provided before poor snow conditions limit intake.

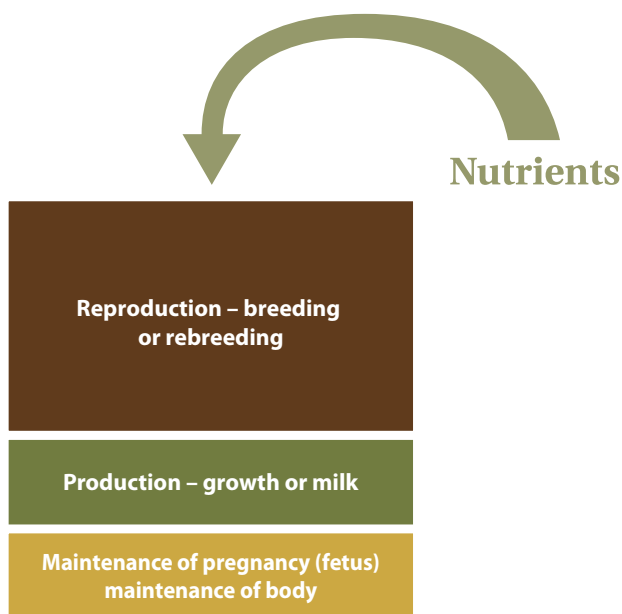
## Nutrient Requirements for Feeding Programs

In a cow-calf operation, the levels of the various nutrients required depends on whether you are feeding for maintenance, maintenance plus production or maintenance plus reproduction.

You can more easily see the relationship between maintenance, production and reproduction if you picture a non-pregnant animal as a barrel into which nutrients are poured (Figure 44). First, maintenance requirements need to be met. The animal requires nutrients to maintain its weight. If not enough nutrients are supplied, it will lose weight. Adding more feed and nutrients meets the production expectation of growth. Finally, if yet more feed and nutrients enter the body, the animal is able to reproduce.

The first requirement, that of maintenance, is defined as the amount of feed that must be fed to keep an animal at a particular weight without any significant change in body composition. The maintenance requirement includes the amount of nutrients needed to maintain essential body functions such as respiration, heart rate, eating and keeping warm. It also includes the nutrients needed to replace the nutrients excreted daily from the body. Tissues of the body are constantly undergoing breakdown and repair. Therefore, nutrients are required to replace the proteins and minerals lost. There are specific maintenance requirements for each of the essential nutrients.

Requirements for production are the next to be met. These requirements are the amounts of nutrients needed for growth. Large quantities of feed may be needed to meet these requirements. A growing calf or heifer needs much higher



**FIGURE 44.** Priority of use for nutrients

concentrations of protein and energy in its feed compared to a mature cow.

Finally, with further amounts of nutrients, the animal will reproduce by breeding if it's a heifer or rebreeding if it's a mature cow. The pregnant animal requires nutrients to maintain its body's weight and functions, as well as maintaining the pregnancy. If the pregnant animal is short of nutrients, it will lose body weight as it tries to maintain the pregnancy. The first priority for maintenance now becomes one of maintaining the pregnancy. The maintenance of body weight becomes a secondary requirement of maintenance. If the nutrient shortage is so severe that the animal reaches a point where it can not maintain its body (i.e. it approaches death) as well as the pregnancy, it will abort the fetus. Usually, beef cows in good body condition can lose body condition and maintain the pregnancy, producing a live, healthy calf.

Once the calf is born, the production requirements need to be met by pouring more nutrients into the second level of the barrel to meet the requirement of milk production.

Since cows are pregnant for 75 per cent of the year, usually when feed costs are the highest, producers must be concerned with the requirements for maintenance of pregnancy, production (milk) and reproduction (rebreeding).

A lactating cow may need about 50 per cent more energy and protein than a dry cow in order to meet her body's nutrient needs for milk production and rebreeding. In addition, to the feed needed to maintain body weight, the cow requires extra feed to conceive.

Although requirements for production and reproduction are shown as being separate in the illustration, they can in fact be closely related. Some cows in a herd may reduce milk production and rebreed if the amounts of some nutrients supplied are borderline, while other cows may respond in the opposite way. The various factors that determine the level of nutrients required by an animal can be summarized as follows:

- body weight
- species or breed
- age and sex
- weather (season, temperature, wind speed, humidity)
- physiological and hormonal state of the animal
- activity level
- previous nutrition level
- the level at which a nutrient is fed and the chemical form in which it is fed
- the overall balance of nutrients

All of these factors must be considered when formulating rations for a cow-calf operation. In cow-calf nutrition, the object is to formulate balanced rations that supply all the required nutrients at adequate levels, in a proper balance and at minimum cost.

Feed analysis and computer ration balancing programs allow you to fine tune your feeding program. However, they do not replace the need to actively manage the feeding program. You need to be constantly aware of changes in weather, feed quality, waste and feed intake. Monitor body condition (see the *Herd Management* chapter) and weight to ensure that the feeding program is achieving the desired results.

TABLE 39. Average nutrient content of commonly used Alberta feeds

Feed	Dry matter (%)	Digestible energy (Mcal/lb.)	Total digestible nutrients (%)	Crude protein (%)	Calcium (%)	Phosphorus (%)	Magnesium (%)	Potassium (%)
<b>Hay</b>								
Alfalfa	87.9	1.27	63.79	18.2	1.71	0.20	0.33	1.72
Alfalfa-grass	87.4	1.22	61.04	14.0	1.22	0.19	0.26	1.65
Grass hay (e.g. brome)	89.9	1.20	60.13	10.6	0.46	0.17	0.17	1.50
Native grass	91.0	1.12	56.12	8.6	0.43	0.12	0.14	1.25
Ryegrass	85.7	1.21	60.74	13.2	0.47	0.22	0.19	1.62
<b>Silage</b>								
Alfalfa	44.6	1.21	60.43	18.2	1.77	0.25	0.27	1.82
Barley	36.8	1.25	62.56	11.1	0.46	0.27	0.27	1.60
Corn	28.8	1.25	62.56	9.0	0.28	0.24	0.24	1.42
Oat	37.9	1.21	60.43	10.6	0.40	0.24	0.26	1.74
Triticale	39.7	1.23	61.65	10.3	0.30	0.23	0.03	1.41
<b>Greenfeed</b>								
Barley	85.9	1.32	65.95	11.8	0.41	0.22	0.23	1.83
Oat	85.8	1.25	62.56	9.9	0.31	0.20	0.26	1.96
<b>Straw</b>								
Barley	89.1	0.89	44.57	5.0	0.13	0.08	0.13	1.40
Oat	89.2	0.98	48.75	4.5	0.26	0.10	0.17	1.55
Pea	89.2	1.08	53.91	12.0	1.39	0.90	0.23	1.30
Wheat	89.1	0.89	44.57	4.0	0.13	0.08	0.13	1.40
<b>Chaff</b>								
Barley	90.0	0.94	47.35	6.0	0.50	0.13	0.13	1.42
Oat	89.0	1.04	52.17	7.5	0.51	0.15	0.17	1.55
Wheat	90.0	0.87	43.75	5.0	0.28	0.09	0.10	1.24
<b>Grain</b>								
Barley	88.5	1.66	83.10	12.5	0.07	0.38	0.14	0.54
Corn	89.0	1.76	88.18	10.0	0.03	0.29	0.13	0.37
Oat	90.2	1.52	76.15	11.3	0.08	0.34	0.16	0.47
Pea	88.2	1.74	87.16	23.9	0.17	0.40	0.14	1.04
Triticale	90.2	1.67	83.77	16.1	0.06	0.34	0.17	0.49
<b>Grain by-product pellets</b>								
11% Range pellets	90.0	1.43	71.65	12.2	0.20	0.78	0.17	0.33
Grain screenings	89.0	1.50	75.16	15.0	0.07	0.95	0.31	0.88
Canola screenings	87.0	1.37	68.69	15.7	0.71	0.95	0.27	1.00
<b>Supplements</b>								
32-Protein supp	90.0	1.28	64.09	35.6	5.56	1.11	0.22	0.44
32-20 Feedlot	90.0	1.23	61.65	35.6	8.89	0.56	0.22	0.44
Canola meal	91.9	1.40	70.03	39.2	0.75	1.26	0.62	1.31
Soybean meal	89.7	1.72	86.14	52.4	0.39	0.75	0.35	2.19
<b>Mineral</b>								
18:18 (1:1 mineral)	99.0	0.00	0.00	0.0	18.18	18.18	0.00	0.00
19:9 (2:1 mineral)	99.0	0.00	0.00	0.0	19.19	9.09	0.00	0.00
Limestone	99.0	0.00	0.00	0.0	38.38	0.00	0.00	0.00

Note: (1) All values are reported on a dry matter (DM) basis

(2) Value of nutrient (as fed) = nutrient value (dry matter basis or moisture-free) x (% dry matter)/100



## Nutrient Content of Various Feeds

Nutrients are found in varying amounts in all feedstuffs. Table 39 lists some of the feeds commonly used in cow-calf operations, along with the nutrient levels contained in them. Note that the values listed are averages. Few feeds contain exactly these levels of nutrients, so rations calculated using these levels are only approximations. Send samples of your feeds for testing and analysis to identify specific nutrient levels (like protein, energy or trace minerals).

## Feed Intake

Estimates of dry matter intake expressed as a percentage of body weight on a dry matter basis are an excellent tool to monitor cattle in terms of their ongoing progress, to predict performance and/or to identify problems.

It is generally thought that cattle on high-roughage rations limit their intake by physical means. They simply cannot fit anymore feed in the rumen. The rumen is full. Physical limitation to feed intake is partially a function of rate of digestion and therefore rate of passage of feed from the gut. If the rate of digestion can be increased, then the rate of passage will most likely increase. This allows the animal to consume more dry matter. If the rate of digestion is slow, feed intake is limited due to a full rumen.

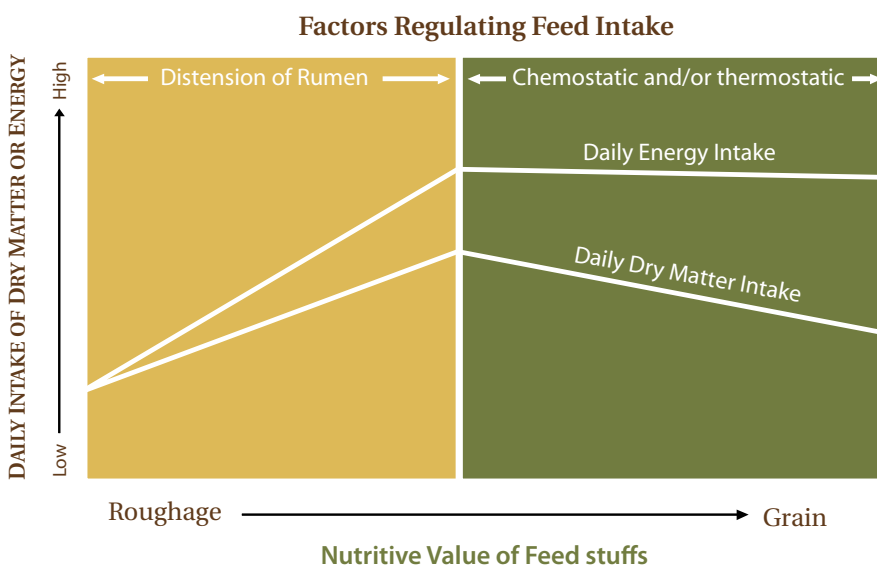
However, cattle consuming a high-grain (energy) ration do not stop eating because they can no longer fit any more feed in the rumen. Feed intake on a high-energy ration is limited by total energy intake. The brain says, do not consume any more energy.

These relationships are shown in Figure 45. These concepts help you to understand and correct problems with low dry matter intake in cattle consuming high-roughage and high-concentrate rations. For example, if you feed long straw or long chopped silage, you may run into dry matter intake problems for cattle fed a high-roughage diet, but it probably will not significantly influence dry matter intake in cattle fed a high-grain ration.

## Estimates of Dry Matter Intake

Dry matter intake (DMI) alone is an ineffective feed consumption tool. However, if DMI is compared to a benchmark, then it becomes a very important feed management tool. Table 37 shows expected DMI of various classes of cattle.

Dry matter intake is influenced by many factors, these factors do not act alone and there are an unlimited number of interactions. Beef cattle consume feed (dry matter basis) at the rate of 1.4 to 3.0 per cent of their body weight. Feed consumption or DMI varies depending on the ration's concentrate to roughage ratio, and on the age and condition of the animal. For example, grass hay or forages may be consumed at 3.0 per cent of body weight, whereas straw consumption tops out at 1.5 per cent of body weight. Older and fleshier cattle consume less feed per unit of body weight than younger, leaner animals. Using these figures, along with some common sense as to practical management, producers can formulate rations that animals have the ability to consume.



**FIGURE 45.** Relationship of the nutritive value of feed to factors limiting feed intake

TABLE 40. Forage<sup>1</sup> and grain dry matter intake guidelines, as per cent of body weight (BW)

Class of cattle	Forage intake (% BW/day)		
	Straw and poor forage	Medium quality forage	Excellent quality forage
Dry mature cows and bulls	1.4 to 1.6	1.8 to 2.0	2.3 to 2.6
Lactating cows	0	2.0 to 2.4	2.5 to 3.0
Growing and finishing cattle	1.0	1.8 to 2.0	2.5 to 3.0
<b>Grain intake guidelines</b>			
Class of cattle	Grain intake (% BW/day)	Desired average daily gain	
		(kg)	(lb.)
Growing cattle	0	0.25 to 0.05	0.5 to 1.0
	1	0.7	1.5
Finishing cattle	1.5	0.9	2
	2.0 to 2.2	1.4	3
Class of cattle	Roughage type	Recommended grain intake	
		(kg/day)	(lb./day)
Dry beef cows	Straw	2.0 to 4.0	4.0 to 8.0
Nursing beef cows	Straw	3.0 to 6.0	6.0 to 12.0
	Good hay	0 to 4.0	0 to 8.0
Bulls	Straw	3.0 to 5.0	6.0 to 10.0
	Good hay	1.5 to 3.0	3.0 to 6.0

<sup>1</sup> Forage - 90% dry matter basis

## Feeding Management

Winter feeding accounts for 40 to 60 per cent of total production costs, so it is generally of more concern than summer grazing. In summer, body condition can be replaced on the cow at a lower cost. The winter months are also important because they make up most of the gestation period for the herd. Proper feeding during the gestation period and between calving and breeding is essential for good reproductive performance and calf productivity. Proper feeding of bulls is also important, so that they are neither too thin nor too fat at breeding time.

*Checking hay quality.*



Producers must provide enough feed and adequate nutrient levels during the winter to meet the requirements of the different classes of cattle, without providing so much feed that the production costs are uneconomical. The best approach is to supply the animals with a balanced ration that gives them sufficient nutrients to promote optimum efficiency in performance at a reasonable cost. This section discusses ration formulation and suggests rations for a various classes of cattle.

As noted earlier, feed analysis and computer ration balancing programs help the producer to fine tune the feeding needs, but they do not replace the need to actively manage the feeding program. The manager must constantly be aware of changes in weather, feed quality, feed intake and feed wastage or losses. Performance in terms of body condition and weight change must be monitored to ensure that the feeding program is achieving the desired results.

## Guidelines for Ration Formulation

When formulating rations, consider the following:

- The first limiting nutrient in a ration is the one that determines overall growth or production of an animal. It is of little use to supply any additional nutrient to a ration until the deficiency in the first limiting nutrient is resolved. In many cases, energy is the first limiting nutrient in a ration.
- Roughage quality affects the needs for supplemental energy and protein. Immature forages typically contain more energy and protein than over-mature forages. Timing of cutting has a larger effect on forage quality than variety.
- Hay or silage in poor condition (mouldy, heat-damaged or rain-damaged prior to harvest) reduces quality. Any form of spoilage reduces energy and protein content in the feed. If the forage has heated and smells like tobacco or is brown to dark brown, then an acid detergent insoluble nitrogen (ADIN) test is required to determine the amount of protein that is tied to the fibre and is not available to the animal. In some situations extra protein may be needed to meet animal requirements.
- Cereal hay (greenfeed) and cereal silage are normally lower in protein than an alfalfa-grass hay or silage. Most growing rations based on greenfeed or cereal silage require supplemental protein.
- High quality legume forages, if consumed at adequate levels, can supply adequate energy and protein for a cow in late pregnancy.
- Grass hay is usually lower in energy and protein than mixed legume grass hay. Grass hay can usually meet the needs of cows in the second trimester of pregnancy. In the last trimester, grain and a protein supplement may have to be added to the ration.
- Cereal grains such as barley, oats or triticale can be used to supplement energy in cow rations. Most grains are a good source of protein and a fair source of minerals, except calcium.
- Grains high in protein (wheat, peas, lentils, chickpeas) reduce the need for a protein supplement. These high-protein grains are also high in energy and are digested rapidly. There are limits to the amount that can be fed.
- Cereal straw has lower energy and protein levels than grass hay, and it is less digestible than hay or cereal hay. Rumen impaction (refer to the *Cold Weather Feeding and Impaction* section for more information) may occur if properly balanced rations are not provided. Ensure that adequate protein is available by using a protein supplement, screening pellets or canola meal. Provide a good source of energy by using grain or grain screening pellets.
- Chaff has low energy and protein levels similar to straw. It is less digestible than hay or cereal hay. Chaff quality varies with type of crop, stage of maturity, weed content, method of harvest, combine settings, and crop and field variability.

## SIX STEPS IN FORMULATING A RATION

1. Determine nutrient requirements, feed intake and desired weight gain for each class of cattle.
2. Have “on-farm” feeds tested to determine nutrient levels.
3. Determine required “off-farm” feedstuffs (protein supplements, minerals, feed additives, vitamins, etc.).
4. Formulate the rations.
5. Implement the nutritional program and monitor the performance of the cattle.
6. Adjust rations according to weather conditions and animal performance.

## FEED RATION RULES OF THUMB

The following general rules are not a replacement for balancing rations with proven software, but rather an aid to understanding the feed and where it fits in your management system. When reading and analyzing feed test results, always refer to the dry matter (DM) numbers. These have the moisture factored out and allow comparison of all feeds, from silage to grains. If the feed contains less than the suggested levels of energy, protein and minerals in the guidelines, then supplementation is required.

**Energy** - using total digestible nutrients (TDN) per cent, the rule is 55-60-65.

This rule says that for a mature beef cow to maintain her body condition score (BCS) through the winter, the ration must have a TDN energy reading of 55 per cent in mid pregnancy, 60 per cent in late pregnancy and 65 per cent after calving.

Remember, energy values in the feed test results are a mathematical calculation done by the computer in the feed laboratory, so monitor the condition of your cows to check that they are receiving enough energy.

Energy can be monitored in the beef cow by watching body condition score (BCS). Low-energy rations result in a loss of body condition. Other measures of energy include digestible energy (DE), metabolizable energy (ME), net energy (NE), net energy of maintenance (NEm), net energy of lactation (NEL) and net energy of gain (NEg). Producers can develop their own rules for these measures if the need arises. It is best to learn one of the six measures of energy and stick with it.

**Crude protein (CP) (%)** - the rule is 7-9-11. An average mature beef cow requires seven per cent crude protein in mid pregnancy, nine per cent in late pregnancy and 11 per cent after calving.

**Calcium:phosphorus ratio** - the rule is 1.65:1 up to 7:1, assuming the actual supplied grams of each are adequate.

The ratio is calculated by dividing the dry matter Ca per cent by the dry matter P per cent.

Ratios outside this range need to be addressed by using feed blends or commercial minerals.

**Tetany ratio** - the rule is potassium (K): calcium (Ca) plus magnesium (Mg) [K:(Ca + Mg)] should not exceed 2.2:1.

The combination of high K (rule of thumb – over 1.75 per cent) and low Ca (rule of thumb – under 0.6 per cent) and low Mg (rule of thumb – under 0.35 per cent) can lead to animal performance issues. Because this ratio involves three different numbers, producers are encouraged to look at each of the three individually and as a ratio to determine if a potential problem exists. (Refer to the tetany ratio calculations in the *Potassium* section.)

## Managing Feed Wastage

Feed wastage can increase the cost of winter feeding and cause a loss of nutrients. Traditionally it has been estimated that feed wastage by cows could average 10 to 20 per cent. The amount of feed offered to cows should be increased to make up for the amount of feed and nutrients they waste. A study was conducted over 2004 and 2005 to measure the losses that occur when feeding dry hay, either processed or unrolled, on the ground versus hay processed into portable feed bunks.

Alberta Agriculture and Food conducted the feeding project in conjunction with the Western Forage/Beef Group at the Lacombe Research Centre in Lacombe, Alberta. Meadow brome was fed to bred heifers during the winter period. Feed wastage was collected and measured after the heifers ate from feed processed onto the snow, unrolled onto the snow and processed into the feed bunk. The wasted feed was sieved over a ¾-inch screen and weighed to determine the amount of fine and coarse material (Table 41).



TABLE 41. Feed supplied versus feed consumed and wasted, by delivery system and particle size

Delivery system		Total amount fed kg (lb.)	Feed consumed kg (lb.)	Feed wasted kg (lb.)
Unrolled onto snow	-coarse particles	21.19 (46.72)	19.54 (43.08)	1.65 (3.64)
	-fine particles	1.51 (3.33)	0.37 (0.82)	1.14 (2.51)
Processed onto snow	-coarse particles	18.41 (40.59)	15.9 (35.05)	2.51 (5.53)
	-fine particles	4.29 (9.45)	2.17 (4.78)	2.12 (4.67)
Processed into feed bunk	-coarse particles	18.41 (40.59)	18.41 (40.59)	0 (0)
	-fine particles	4.29 (9.45)	4.29 (9.45)	0 (0)

Source: Western Forage/Beef Group (2005)

Total feed losses for the three methods of feed delivery were as follows:

- processed onto the snow 19 per cent
- unrolled onto the snow 12 per cent
- processed into the feed bunk 0 per cent

Feed quality is also lost when feeding on snow. Nutrient quality samples were collected from coarse and fine material collected at the time of feed delivery. All feed samples were analyzed for nutrient levels according to particle size. Measurements were made for protein, fibre and macro-minerals. Protein and neutral detergent fibre (NDF) results are presented in Table 42. The fine particle material from processed feed and the unrolled bales contained higher protein values than the whole bale sample, indicating that the fine particle wastage contains high amounts of protein and it is also lower in fibre (NDF) than the coarse material. A loss of fine materials results in cows consuming a lower quality ration than what is reported when the whole bale is analyzed.

TABLE 42. Nutrient quality of feed, by delivery system and particle size

Delivery system		Crude protein (%)	Neutral detergent fibre (%)
Whole bale		11.6	67.6
Unrolled onto snow	-coarse particles	10.5	66.9
	-fine particles	17.3	54.8
Processed onto snow	-coarse particles	10.7	67.0
	-fine particles	15.5	55.0

Source: Western Forage/Beef Group (2005)

The reduction in feed quantity and quality from feeding on snow can lead to various problems. Lower forage quality due to fine material loss can reduce animal performance. Losses of calcium and magnesium in the fine particle material may create the potential for milk fever and/or winter tetany to occur. Rations may need to be adjusted accordingly to maintain animal performance. The amount of feed and quality of feed offered to cows should be increased to make up for the amount of feed and nutrients they waste. To reduce the loss of feed and feed quality, use a portable feed bunk, a fixed-in-place feed bunk or a round bale feeder.

## Body Condition of Cows

The condition of cows going into winter has a major effect on the amount and quality of feed they need. Cows in thin condition in the fall must gain weight throughout the winter. As a result, they must be fed good quality roughage, or average quality roughage and some grain.

Cows in good condition in early winter need only enough feed to maintain their weight until calving. In this case, poor quality hay or good straw can be the major component of the feeding program. If cows are in good condition in early winter, good quality straw can be used for as much as 75 per cent of the cows' diet until about six weeks before calving.

Straw can be fed in conjunction with medium to good quality hay, grain, protein supplement or combinations of these materials. Straw is only slightly lower in energy than average quality hay, but is usually low in protein, minerals and vitamins. As a result, additional quantities of these nutrients must be provided. In most cases, grain or high quality hay will supply the additional energy needed.

## Cold Weather Feeding and Impaction

Whenever cows are fed on low quality diets, such as straw or poor quality hay, or the amount of feed offered is closely controlled, good management of the herd becomes more critical. Impaction occurs when poor quality feed moves through to the fourth stomach before it is properly digested by the rumen micro-organisms, and it becomes impacted in the fourth stomach.

*Eating poor quality feed can lead to impaction.*



Wintering cows that are fed large amounts of poor quality ground or hammered roughage (e.g. straw) are susceptible to impaction. Frequently, the grain or energy intake is low. In cold weather and during late gestation, when an animal's nutritional requirement increases, the consumption of feed increases, but if the animal's ability to digest is poor, impaction results. The cows keep eating to keep warm in winter. They look big and full, but on close examination they are found to be generally quite thin, with their ribs showing.

In these situations it is important to know the exact quality of the feeds being used. Feed testing and proper application of the feed test results become increasingly important. If not enough energy is fed with the straw, it may not be digested fully. Excessive quantities of undigested feed may accumulate, physically impairing rumen function and resulting in impaction. During impaction, the rumen is usually full, firm and doughy, and primary contractions are absent. However, secondary contractions may be present. For more details, refer to the *Impaction* section in the *Animal Health Management* chapter.

It is often beneficial to divide the cow herd into two or three different groups for winter feeding. The first group should be the young, mature cows that are in good condition. They need the least amount of care to get them through the winter in good condition.

The second group should include heifers that will calve for the first or second time. They are young, growing animals that cannot compete effectively for feed with the mature cows unless all the cows are considerably overfed. This group requires either a better quality hay or more supplemental grain than the mature cows.

The third group should be made up of thin and old cows. These cows also need additional feed to get them through the winter. Again, they have trouble competing with the more aggressive mature cows that are in better condition.

If your cows cannot be handled in three groups, combine the heifers and the old, thin cows in one group. It might be wise to send some of the old, thin cows to slaughter.

## Winter Feeding of Cows and Replacement Heifers

### WINTER-FEEDING RATIONS FOR COWS IN MID PREGNANCY

Most winter-feeding programs for cows require supplemental minerals and salt. Trace minerals and salt should be available on a free-choice basis. In addition, rations based largely on hay should be supplemented with a mineral containing equal parts of calcium and phosphorus, also available on a free-choice basis. Rations based on greenfeed, cereal silage, straw and grain should be supplemented on a free-choice basis with a mineral containing two parts of calcium and one part of phosphorus. The amount of mineral consumed should be 30 to 100 grams per head per day, depending on the type of mineral being fed. Follow the instructions on the packaging. You may have to mix salt with the minerals to get the cows to consume enough.

Prior to calving a beef cow requires 30,000 to 40,000 IU of vitamin A daily. After calving, but before the cow has access to green grass, she requires 60,000 to 70,000 IU of vitamin A daily. Superior milking cows need the higher amount.



*Pasture feeding cows during early winter.*

Vitamin A is stored in the liver and is used when needed. It can be fed daily, at two- to three-week intervals, or at one- to two-month intervals. Alternatively, a sufficient supply can be injected every two or three months. The important thing to remember is that enough vitamin A must be supplied to meet the cow's daily requirement. If the cow is given vitamin A once a month, she must receive a 30-day supply at that time.

The sample rations in Table 43 were balanced using the CowBytes® Beef Ration Balancer computer program. They are designed to meet the needs of a 590 kg (1,300 lb.) mature, pregnant beef cow that is gaining 0.25 kg (0.5 lb.) per day under normal winter conditions in central Alberta.

TABLE 43. Example rations for a 590 kg (1,300 lb.) cow at mid pregnancy

Feed ingredient	Amounts as fed per day – kg (lb.)				
	Ration 1	Ration 2	Ration 3	Ration 4	Ration 5
Alfalfa-grass hay	3.9 (8.6)				
Grass hay		6.3 (14)	12.7 (28)		
Cereal straw	7.3 (16)			4.9 (12)	5.4 (12)
Cereal hay (greenfeed)		5.8 (13)		5.8 (15)	
Cereal silage					15.8 (35)
Grain barley, oats, or grain screenings pelleted	1.5 (3.3)			1.8 (4)	
32% Protein supplement					
19:9 Mineral (2:1)				0.06 (0.13)	0.08 (0.17)
Trace mineralized salt	0.027 (0.06)	0.027 (0.06)	0.027 (0.06)	0.027 (0.06)	0.027 (0.06)
Limestone	0.027 (0.06)	0.04 (0.08)		0.03 (0.08)	
Vitamin ADE	0.004 (0.008)	0.004 (0.008)	0.004 (0.008)	0.004 (0.008)	0.004 (0.008)
<b>Total – As-fed intake</b>	<b>12.7 (28)</b>	<b>12.2 (26.4)</b>	<b>12.7 (28.1)</b>	<b>14.5 (31.3)</b>	<b>21.5 (47.3)</b>
<b>Estimate – Dry matter intake</b>	<b>11.3 (25)</b>	<b>10.8 (23.9)</b>	<b>11.4 (25.2)</b>	<b>12.4 (27.4)</b>	<b>10.8 (23.9)</b>

The following rations are based on the average nutrient content of Alberta feeds. These rations should contain adequate amounts of energy and protein, but require mineral and vitamin supplementation. Have your feeds analysed so you can accurately adapt these rations to your situation.

These rations do not make allowance for feed wastage by cows. The amount of feed offered to cows should be increased to make up for the amount of feed they waste (for more information, refer to the *Managing Feed Wastage* section in this chapter).

Although these rations make some allowance for cold weather, under very cold conditions additional feed will be required to meet the cows' needs for energy. For every 10 C that the mid-day temperature is below -20 C an additional 3 kg (6.6 lb.) of hay, 6.2 kg (13.7 lb.) of silage or 2 kg (4.4 lb.) of grain should be fed, depending on the type of ration being used.

The thin and old cows will likely weigh 50 kg (110 lb.) to 100 kg (220 lb.) less than young, mature

cows in good condition. As a result, these cows will have a lower maintenance requirement in normal winter conditions. However, thin cows have less fat for insulation against heat loss and very little energy in reserve to draw on. Under cold conditions (below -20 C), they require special attention. Provide them with more feed than cows in good condition. The feed should be of good quality so that the cows will readily consume it. The feed should be offered in an area that is protected from the wind.

Bred heifers will have about the same daily nutrient requirements as young, mature cows. Since heifers are smaller than mature cows, they cannot consume as much poor quality feed. However, they should be able to consume the quantity of alfalfa-grass hay, greenfeed or cereal silage suggested for mature cows. For the straw/ grain diets, an additional 1.5 kg (3.3 lb.) of grain should be fed. Straw consumption is likely to decrease by about 2.5 kg (5.5 lb.). Another possible ration would be 7 kg (15.4 lb.) of grass hay and 2 kg (4.4 lb.) of grain.

TABLE 44. Example rations for a 590 kg (1,300 lb.) cow at late pregnancy

Feed ingredient	Amounts as fed per day – kg (lb.)				
	Ration 1	Ration 2	Ration 3	Ration 4	Ration 5
Alfalfa-grass hay	5.9 (13)				
Grass hay		12.5 (28)	6 (13)		3.6 (8)
Cereal straw	4.5 (10)			4.5 (10)	
Cereal hay (greenfeed)			5.5 (12)	6.8 (15)	
Cereal silage					22 (48)
Grain barley, oats, grain screenings pelleted	2.5 (5)		1 (2)	1.8 (4)	1.0 (2.2)
32% Protein supplement or canola meal				0.36 (0.8)	
19:9 mineral (2:1)			0.06 (0.13)	0.08 (0.18)	
Trace mineralized salt	0.03 (0.06)	0.03 (0.06)	0.03 (0.06)	0.03 (0.06)	0.03 (0.06)
Limestone					0.03 (0.06)
Vitamin ADE	0.004 (0.008)	0.004 (0.008)	0.004 (0.008)	0.004 (0.008)	0.004 (0.008)
<b>Total – As-fed intake</b>	<b>13.0 (28.6)</b>	<b>12.7 (28.1)</b>	<b>12.6 (27.7)</b>	<b>13.6 (31.0)</b>	<b>26.5 (58.1)</b>
<b>Estimate – Dry matter intake</b>	<b>11.5 (25.3)</b>	<b>11.6 (28.1)</b>	<b>11.1 (24.4)</b>	<b>11.9 (26.3)</b>	<b>12.2 (26.8)</b>



## WINTER-FEEDING RATIONS FOR COWS IN LATE PREGNANCY

During the last six weeks to two months before calving, the amount of nutrients supplied in a ration should be increased by about 15 per cent. This can be accomplished either by feeding more of the wintering ration or by substituting some good quality feed for some of the low quality feeds used in the ration. The sample rations in Table 44 are balanced for a 590 kg (1,300 lb.) cow during late pregnancy in winter with an expected calf birth weight of 36 to 40 kg (80 to 90 lb.). These rations do not make allowance for feed wastage.

## AFTER-CALVING LACTATION RATIONS FOR COWS

A cow's need for nutrients increases substantially after calving. The requirements of superior milking cows increase more than those of average milking cows. Superior milking cows require about 60 per cent more energy, 115 per cent more protein and 85 per cent more phosphorus after calving than they required in the middle of winter. If the cow's requirements are not met, a cow may take longer to begin cycling, have weak or irregular estrous signs or have lower conception levels. As a result, the cow may either not conceive or may conceive late in the breeding season. (For more information, see Table 30.)

Depending on when the cows are calving, they are normally fed stored feeds for all or part of the time between calving and rebreeding. This is the most critical time of the year for cows and often is a time when their needs are neglected. Proper feeding at this time of the year pays dividends in the next calving season. The best quality feeds should be saved for this time of the year.

The rations in Table 45 will meet the energy and protein needs of a 590 kg (1300 lb.) cow producing 8.6 kg (19 lb.) of milk. These rations do not make allowance for wastage.

After calving, the cow's requirement for supplemental minerals increases from 60 to 150 g (2 to 5 oz.) per cow per day, depending on the amount of milk the cow is producing and the type of feed being used. After calving, a mineral supplement containing equal parts of calcium and phosphorus is the normal practice. If cows are fed grain at this time, a salt-free mineral can be mixed with the grain, as cows usually will not consume a sufficient amount of mineral free-choice. In addition, trace mineralized salt should be fed on a free-choice basis. As noted, the vitamin A requirement after calving increases to 60,000 to 70,000 IU per head per day.

TABLE 45. Sample rations for a 590 kg (1,300 lb.) cow producing 8.6 kg (19 lb.) of milk

Feed ingredient	Amounts as fed per day – kg (lb.)			
	Ration 1	Ration 2	Ration 3	Ration 4
Alfalfa-grass hay	10 (22)			
Grass hay		11.3 (25)		
Cereal straw	2.7 (6)			
Cereal hay (greenfeed)			11.3 (25)	
Cereal silage				30.8 (68)
Grain barley, oats, or grain screenings pelleted	2.7 (6)	3 (6.6)	3.2 (7)	2.0 (4.5)
19:9 mineral (2:1)			0.07 (0.15)	
18:18 mineral (1:1)	0.023 (0.05)	0.023 (0.05)		
Trace mineralized salt	0.036 (0.08)	0.036 (0.08)	0.039 (0.086)	0.039 (0.086)
Limestone			0.05 (0.12)	0.019 (0.04)
Vitamin ADE	0.006 (0.013)	0.006 (0.013)	0.004 (0.01)	0.007 (0.015)
<b>Total – As-fed intake</b>	<b>15.5 (34.1)</b>	<b>14.4 (31.7)</b>	<b>14.7 (32.4)</b>	<b>32.9 (72.6)</b>
<b>Estimate – Dry matter intake</b>	<b>13.6 (30.0)</b>	<b>12.9 (28.4)</b>	<b>12.7 (28)</b>	<b>13.2 (29.1)</b>

## WINTER-FEEDING OF REPLACEMENT HEIFER CALVES

Feed replacement heifer calves so they reach the desired weights listed in Table 46 for first breeding at 14 to 15 months of age and for first calving. The weight recommendations for first calving should minimize calving difficulty and optimize productivity of growing heifers.

TABLE 46. Target weights for developing replacement heifers

Type of heifer	Desired minimum weights – kg (lb.)	
	At first breeding	At first calving
British breeds	300 (660) to 320 (705)	380 (837) to 410 (904)
Exotic breeds	340 (750) to 362 (800)	430 (948) to 460 (1,014)

To be large enough to breed, heifers have to weigh at least 300 kg (660 lb.) to 350 kg (800 lb.) at 14 to 15 months of age, depending on the breed (Table 46). Heifers have to gain at the rate of about 0.7 kg (1.5 lb.) to 0.9 kg (2 lb.) per day throughout the winter to reach the desired first breeding weights. Sample rations for this rate of gain are shown in Table 47. The comments about minerals, salt and vitamin A in the next section about growing calves, also apply to replacement heifer calves. These rations do not make allowance for feed wastage by calves.

TABLE 47. Example rations for replacement heifers gaining 0.8 kg (1.8 lb.) per day

Feed ingredient	Amounts as fed per day – kg (lb.)		
	Ration 1	Ration 2	Ration 3
Alfalfa-grass hay	4.5 (10)		
Grass hay		6.35 (14)	
Cereal straw	1.3 (3)		
Cereal silage			11.3 (25)
Grain barley, oats, or grain screenings pelleted	3.0 (6.5)	3.1 (7)	2.6 (6)
Canola meal or protein supplement		0.18 (0.4)	0.3 (0.68)
18:18 mineral (1:1)			
Trace mineralized salt	0.02 (0.045)	0.02 (0.045)	0.039 (0.086)
Limestone			0.023 (0.05)
Vitamin ADE	0.005 (0.01)	0.005 (0.01)	0.007 (0.015)
<b>Total – As fed intake</b>	<b>8.9 (19.6)</b>	<b>14.4 (31.7)</b>	<b>15.92 (35.1)</b>
<b>Estimate – Dry matter intake</b>	<b>7.6 (16.9)</b>	<b>7.9 (21.6)</b>	<b>7.2 (15.8)</b>

These rations have been formulated to supply the calves with the quantity of feed they should receive at the midpoint of the feeding period. At the start of the feeding period, calves should be fed about 10 to 15 per cent less, whereas at the end of the feeding period they should be consuming 10 to 15 per cent more. In very cold weather, the average daily gain of the calves will probably be less than the target gain. To maintain the targeted rate of gain through very cold weather, increase the grain portion of the ration by 20 per cent.



*Feeder calves waiting for the feed truck.*

## Feeding of Backgrounding and Finishing Cattle

### BACKGROUNDING PROGRAMS

Backgrounding diets are designed to control the growth of the animal. They are usually forage-based and relatively low in energy. Feed costs are often minimized by the inclusion of by-product feeds such as straw, chaff or grain screening pellets. Most backgrounding rations contain 40 to 60 per cent forage, with the balance consisting of grain or pelletized screenings and supplements. As the backgrounded calves grow, increasing the amount of grain fed gradually raises the energy component or total digestible nutrients (TDN) of the ration, increasing the energy available for growth.

Most backgrounding rations require additional salt and minerals. Trace mineralized fortified salt is recommended. In addition to salt, it contains a number of required trace minerals (e.g. copper, zinc, manganese and sometimes selenium). Calcium and phosphorus are important for proper skeletal growth and development of backgrounded calves. If the forage and grain component of the rations do not supply adequate levels of these minerals, they must be provided as a supplement.

The feeding programs for backgrounding are based on a number of factors. These include: the type and weight of cattle purchased, delivery date, target weight and the negotiated conditions of sale. Backgrounding cattle are usually fed to reach

a weight of about 363 to 408 kg (800 to 950 lb.), depending on the target feeder market (Table 48).

### TYPE AND WEIGHT OF CATTLE

The frame size, purchase weight and sex of cattle will dictate the backgrounding feeding program. Medium frame steer calves can be fed rations that permit daily gains of 0.8 to 0.9 kg (1.75 to 2.0 lb.). Large frame steer calves can be fed rations that permit daily gains of 1.0 to 1.2 kg (2.25 to 2.7 lb.). When feeding heifers, the rations should allow daily gains of 0.7 to 0.8 kg (1.5 to 1.75 lb.) for medium frame animals and up to 1.1 kg (2.5 lb.) for larger frame females. Rations formulated to these rates of gain promote muscle and frame development (Table 48).

### DELIVERY DATE AND TARGET SALE WEIGHT

The number of days on feed and target sale weight of backgrounded cattle have a significant bearing on the feeding program. The length of the feeding program is determined by the expected sale date or the delivery date specified in a forward contract. For example, 249 kg (550 lb.) medium frame steer calves placed on feed in mid-October and targeted for sale in mid-April will be on feed for 150 days. If the target sale weight is 385 kg (850 lb.), a ration designed to allow a daily gain of 0.9 kg (2.0 lb.) is required [i.e.  $136 \text{ kg}/150 \text{ days (d)} = 0.9 \text{ kg/d}$  ( $300 \text{ lb.}/150 \text{ d} = 2.0 \text{ lb./d}$ )].

If the cattle were to be sold in mid May, a ration designed to allow for a daily gain of 0.77 kg/d [1.7 lb./d] is required (i.e.  $136 \text{ kg}/180 \text{ d} = 0.77 \text{ kg/d}$  ( $300 \text{ lb.}/180 \text{ d} = 1.7 \text{ lb./d}$ )). The longer the feeding period, the less we expect from the cattle in terms of performance. In contrast, the heavier the target sale weight, the higher the rate of gain required.

Target weights (Table 48) vary with the type of animal fed and the objectives of the owner and/or feedlot operator. Usually, medium frame steer calves are grown to 385 to 408 kg (850 to 900 lb.) before being placed on a finishing diet or into a finishing feedlot. Large frame steer calves can be taken to 408 kg (900 lb.) if they are to be finished for the Canadian market or to 430 kg (950 lb.) if destined for the United States.

TABLE 48. Targets weights for cattle fed for Canadian vs. American markets

	Small frame	Medium frame	Large frame
<b>Weaning or purchase weight</b>	136 - 181 kg (300 - 400 lb.)	181 - 227 kg (400 - 500 lb.)	227 - 272 kg (500 - 600 lb.)
<b>Backgrounding gain</b>			
Steers	0.68 - 0.80 kg/day (1.50 - 1.75 lb./day)	0.68 - 0.9 kg/day (1.50 - 2.00 lb./day)	1.0 - 1.3 kg/day (2.25 - 2.8 lb./day)
Heifers	0.68 - 0.80 kg/day (1.50 - 1.75 lb./day)	0.68 - 0.80 kg/day (1.50 - 1.75 lb./day)	0.9 - 1.13 kg/day (2.00 - 2.5 lb./day)
<b>Target feeder weight and destination</b>			
To grass	295 - 317 kg (650 - 700 lb.)		
To finishing diet or finishing feedlot	317 - 363 kg (700 - 800 lb.)		
Steers and heifers to finishing programs		340 - 408 kg (750 - 900 lb.)	374 - 430 kg (825 - 950 lb.+)
<b>Expected slaughter weight</b>			
<b>Steers</b>			
Canadian	454 - 476 kg (1,000 - 1,050 lb.)	500 - 544 kg (1,100 - 1,200 lb.)	374 - 430 kg (1,150 - 1,300 lb.)
American	500 - 522 kg (1,100 - 1,150 lb.)	567 - 635 kg (1,250 - 1,400 lb.)	590 - 640 kg (1,300 - 1,410 lb.)
<b>Heifers</b>			
Canadian	385 kg (850 lb.)	408 - 454 kg (900 - 1,000 lb.)	454 - 544 kg (1,000 - 1,200 lb.)
American	408 kg+ (900 lb.+)	454 - 476 kg (1,000 - 1,050 lb.)	454 kg+ (1,100 lb.+)

Adapted from: Block (2001), McKinnon (1997)

## FEEDING SYSTEMS TO OPTIMIZE CARCASS QUALITY

To produce beef animals with specific carcass characteristics such as optimal weights, lean yields and high quality grades, it is necessary to slaughter them at the appropriate stage of their growth curve. Animals will exhibit differences in the age and weight at which they achieve certain milestones in their growth and development. For example, early maturing breeds (British breeds) of cattle tend to reach puberty and maturity at relatively lighter weights and younger ages than

late maturing breeds (continental breeds). In comparison to early maturing breeds, the late maturing cattle tend to:

- have larger frame or skeletal sizes
- deposit muscle and live weight gain at faster rates and for longer periods of time
- reach puberty at heavier weights and older ages
- initiate fat deposition at heavier weights
- reach desired carcass quality characteristics at heavier weights and after longer periods of time on feed



These differences have important implications in how we feed and manage feedlot cattle, particularly when the objective is to produce a desired carcass. If you are feeding small to medium frame cattle, it is important to design the feeding program based on knowledge of their stage of growth. Feeding high-energy diets to animals that have been recently weaned results in premature fattening and consequently light and possibly over-fat carcasses (McKinnon et al. 1993). Such growth is the result of supplying too much energy, too early in the animal's growth curve. These animals have not had time to maximize their growth and development of skeletal and muscle tissue. The animal's genetic ability to deposit bone and muscle is overwhelmed and as a result, the extra energy is used for fat deposition. If these animals are fed a relatively low-energy diet (64 to 68 per cent TDN) for a period following weaning, you can manipulate their growth to allow for maximum muscle and bone growth. It is then possible to place these animals on a high-energy feeding program to achieve the desired carcass characteristics at optimal weights.

Large frame cattle, in contrast, take longer to reach desired carcass quality characteristics if fed in the same manner and therefore produce excessively heavy carcasses. Experience has shown that to meet Canadian carcass grade and weight requirements, this class of cattle does not require a period of low-energy feeding to maximize bone and muscle growth. Instead, desirable carcasses can be achieved by placing this type of animal on a high-energy diet shortly after weaning, or after a minimal backgrounding period. Such cattle can reach desirable carcass weights and quality specifications often as early as 12 to 15 months of age. It is common to take such cattle to heavier weights when feeding for American markets. If feeding for the American market, it is not uncommon to grow out or background such cattle to specific yearling target weights that allow for increased finished weights and enhanced marbling scores.

## FINISHING PROGRAMS

In contrast to backgrounding programs, finishing programs are generally targeted to promote rapid weight gain and fat deposition that is consistent with market specifications. Yearling or backgrounded cattle are adapted to and fed high-energy rations for the duration of the feeding program. Finished weight and carcass characteristics will vary with the market for which the cattle have been fed.

Cattle finished for Canadian markets must fall within the highest yield grade (59 per cent lean or better) with a marbling score of at least single A, but the majority of the animals slaughtered in Canada are grade AA or AAA. Optimal carcass weights vary from packer to packer, but generally are within the range of 258 to 340 kg (570 to 750 lb.). Cattle fed to heavier weights or that are excessively fat are discounted.

In contrast, cattle fed for the United States must have a yield grade within the range of 1 to 3 (62 to 63 per cent lean or better) and a quality grade of USDA Choice (equivalent to Canada AAA) to receive the optimal market price. Cattle that grade USDA Select (equivalent to Canada AA) are generally discounted relative to USDA Choice cattle, as are cattle that fall into yield grades 4 or 5. The American market tolerates heavier cattle with carcass weights often reaching 385 to 410 kg (850 to 900 lb.) before any significant discounts are applied.

*These finishing cattle are almost ready for slaughter.*



The basic difference in feeding management between cattle fed for the Canadian and American markets is time on feed (Block et al. 2001). Cattle destined for the United States require a longer period of time on feed to ensure optimal marbling content. Consider for example a 389 kg (857 lb.) medium frame yearling steer that has been backgrounded over the winter. If fed for the Canadian market, this steer would be marketed at approximately 500 to 544 kg (1,100 to 1,200 lb.) after approximately 100 days on a top-end finishing ration (Table 51, Step 7 or 8). The animal would gain 1.36 to 1.45 kg (3.0 to 3.2 lb.) a day, with conversions near 7:1 (dry matter intake (DMI) per lb. of gain) and should grade Canada 1 (59 per cent lean or better) with A, AA or AAA marbling. The same animal fed for the American market would be on feed for another 30 to 50 days and fed to 567 to 639 kg (1,250 to 1,400 lb.). The feeding period would be extended, average daily gain would drop by five to 10 per cent and feed efficiency would suffer accordingly. As a consequence, feed costs per pound of gain would rise. Producer experience in marketing such cattle has shown that such a feeding program results in 50 to 75 per cent of such cattle grading USDA Choice.

Large frame calves with high growth potential can be placed on high-energy finishing programs shortly after weaning. Such cattle can be finished for Canadian market specifications at 500 to 544 kg (1,100 to 1,200 lb.) at between 12 and 15 months of age. These cattle are often on feed for 150 to 180 days, average daily gain should be well in excess of 1.36 kg (3.0 lb.) a day [e.g. 1.45 to 1.5 kg/day (3.2 to 3.4 lb./day)] and feed conversions should be of the order of 6.5 to 7:1. Heavier finishing weights of 567 to 590 kg (1,250 to 1,300 lb.) for the Canadian market can be achieved by subjecting such cattle to short-term backgrounding programs (70 days at 1.13 kg (2.5 lb.) per day) prior to high-energy finishing programs (Table 48).

Large frame cattle intended for the American market are generally not placed on high finishing rations until they reach 385 to 430 kg (850 to 950 lb.). This results in a heavier and more mature animal at slaughter and enhances the number of animals grading USDA Choice. Finishing weights will range from 590 to 635 kg (1,300 to 1,400 lb.) or more. Again, due to a longer feeding period, gains and conversions

are poorer, particularly during the last 30 to 40 days of feeding while the cost of gain is increased relative to similar cattle fed for the Canadian market.

To maximize returns, it is necessary to design the feeding program to target specific carcass quality characteristics of the finished animal. These characteristics can vary within and between markets. To achieve desired carcass quality traits in finished cattle, it is necessary to understand and manipulate the growth of different biological types of cattle. This is accomplished by selective backgrounding or growing out of feeder cattle to specific target weights and high-energy finishing to defined carcass quality end-points.

### STARTER RATIONS

Most feedlots will provide long stem hay to new cattle or freshly weaned calves for a period of three to five days to help get the animals eating and accustomed to the feed bunks. Start to introduce

TABLE 49. Suggested nutrient concentrations for recently weaned calves

Nutrient	Suggested range (units/day)
Dry matter intake	1.55 – 1.90% of body weight
Dry matter	80 – 85%
Crude protein	12.5 – 15%
Energy (TDN)	65 – 68%
<b>Major minerals</b>	
Calcium	0.6 – 0.8%
Phosphorus	0.04 – 0.5%
Potassium	1.2 – 1.4%
Magnesium	0.2 – 0.3%
Sodium	0.2 – 0.3%
<b>Trace minerals</b>	
Copper	10.0 – 15.0 mg/kg
Zinc	75.0 – 100.0 mg/kg
Manganese	40 – 70 mg/kg
Cobalt	0.1 – 0.2 mg/kg
Selenium	0.1 – 0.2 mg/kg
<b>Vitamins</b>	
Vitamin A	4,000 – 6,000 IU/kg
Vitamin E	75 – 100 IU/kg

Source: National Research Council (2000, 1996)

the starter ration (concentrate and silage or chopped hay) as early as Day 2 after arrival in the feed pen. This can be done by top-dressing the ration on top of the hay at a rate of 2.2 to 3 kg (5 to 7 lb.) per head, so that the cattle consume the starter ration when eating the hay. Following Day 2, the amount of long hay offered can be reduced by no more than 10 per cent per day, while the starter ration is increased by 5 to 10 per cent. Usually, by Day 5 to 7 long hay feeding has ceased.

Starter rations typically are total mixed rations and are based on processed forage (hay or silage). Table 49 gives common nutrient specifications for starter rations. Forage to concentrate ratios are typically 70 to 75 per cent forage and 25 to 30 per cent concentrate (DM basis). Feed intake problems are often encountered with recently weaned calves. Feed intake of weaned calves can be as low as 1.5 per cent to 1.9 per cent of body weight (DM basis).

The starter ration is likely to be fed for a period of 14 to 21 days, or until dry matter intake has reached 2.5 to 2.7 per cent of body weight (Table 50). Yearling cattle seldom have difficulty adapting to the starter ration and will achieve dry matter intake levels of 2.4 to 2.5 per cent of body weight, usually within the first week of feeding. Crude protein levels of the starter ration tend to range from 14 to 15 per cent and are relatively low in energy (65 to 68 per cent total digestible nutrients (TDN). To overcome the reduced dry matter intake of newly weaned calves, a starter ration of slightly higher energy levels (70 to 71 per cent TDN) may be formulated and fed to these calves. The starter ration should also be balanced for all nutrients including essential minerals and vitamins. Minerals such as copper, zinc and chromium are closely involved in the immune status of the animal and in some recent research trials, these minerals have been shown to reduce sickness and death loss in newly arrived calves.

TABLE 50. Typical dry matter intakes for calves and yearlings by weight and age

Weight of calves and yearlings – kg (lb.)	Estimates of total dry matter intake (DMI)			
	% body weight basis		kg (lb.)/head/day	
	Calves	Yearlings	Calves	Yearlings
<227 – 250 kg (<500 - 550 lb.) or Starter ration (first 2 - 3 weeks)	1.25 - 1.75	1.75 - 2.25	3.3 - 4.4 (6.9 - 9.6)	4.4 - 6.3 (9.6 - 13.8)
250 kg (550 lb.)	2.5 - 2.6	2.8	6.3 (14)	7.0 (15.5)
300 kg (660 lb.)	2.45	2.7	7.3 (16)	8.1 (17.8)
349 kg (770 lb.)	2.4	2.6	8.4 (18.5)	9.0 (20)
400 kg (880 lb.)	2.35	2.5	9.5 (21)	10.0 (22)
449 kg (990 lb.)	2.25	2.35	10.2 (22.5)	10.4 (23)
500 kg (1,100 lb.)	2.10	2.15	10.4 (23)	12.2 (24)
549 kg (1,210 lb.)	1.90	2.0	10.4 (23)	12.2 (24)

Source: McKinnon (1996)

## STEP-UP RATIOS FOR FEEDER CATTLE

A step-up feeding program is a series of rations formulated to specific nutrient levels. In the case of a backgrounding program there might be five rations involved (rations 1 to 5 in Table 51). In finishing programs there are typically nine rations (rations 1 to 9 in Table 51). Each ration is formulated to a specific energy level and as you move from one ration to the next, there is a consistent increase in energy content. Typically the first ration, the starter ration, is primarily forage-based. As you move up the feeding program, grain is substituted for forage. For example, it is common at each step to substitute 10 per cent grain for 10 per cent forage (DM basis). This results in a steady, consistent increase in energy content at each ration level.

TABLE 51. An example of a step-up program for growing and finishing cattle (per cent dry matter basis)

Ration step	TDN (%)	CP (%)	Ca (%)	P (%)
1	65 - 67	14.0	0.60	0.40
2	66	12.5-13.5	0.60	0.40
3	68	12.5	0.55	0.35
4	70	12.5	0.55	0.35
5	72	12.0	0.50	0.30
6	74	12.0	0.50	0.30
7	76	12.0	0.45	0.25
8	78	11.5 - 12.0	0.45	0.25
9	80	11.5 - 12.0	0.45	0.25

Note: For backgrounding calves, use Steps 1 to 5. For finishing cattle, use Steps 1 to 9. For yearlings, use Step 1 then Steps 4 to 9.

Source: McKinnon (1996)

Most backgrounding and finishing rations require additional salt and minerals. Trace mineralized fortified salt is recommended. Calcium and phosphorus are important for proper skeletal growth and development of growing calves. If the forage and grain part of the rations do not supply adequate levels of these minerals, they must be provided as a supplement.

The levels of other nutrients in the ration are based on the type of cattle being fed. Crude protein levels in the starter ration and the first two to three steps should be around 12 to 14 per cent. This is to accommodate recently weaned calves that are to be backgrounded or grown out over 120 days or more (Table 51). Calcium and phosphorus levels are higher in these rations too. As you move up the step-up program, these nutrients decrease as a percentage of the diet's dry matter while energy content increases. These changes match the changing nutrient requirements of an animal as it moves through the growing and finishing period. In addition to salt and minerals, feed additives and growth promotants may be used to improve feed efficiency and growth performance.

Step-up feeding programs represent a compromise on the part of the feeder with respect to meeting the nutrient requirements of a number of different classes of cattle. The step-up rations are designed for the type of animal that will be on

a given ration or step for the longest time period, such as the grower/feeder period (Table 52) or the finishing period (Table 53). Consider the yearling that has just come off grass. This animal needs to be adapted to high-grain feeding, and it should be placed on the first or second ration when it arrives in the feeding pen. It does not require 12 to 14 per cent crude protein. However, these animals are only on these diets for three to four days before being moved to the next level, so overfeeding of protein is limited. Yearlings only require crude protein levels of about 10 per cent in contrast to recently weaned calves, which have higher crude protein requirements.

The advantages of a step-up feeding program include:

- providing a natural progression in energy levels – This helps to minimize digestive disturbances that can result from acidosis-related problems and assists with moving cattle onto high-grain diets. A step-up feeding program allows the cattle to be started at the first or second level, held at that ration for four to seven days and then moved to the next level. The cattle can be moved through each step in a similar manner until they are on Step 9, which is an 80 to 85 per cent grain diet (dry matter basis). Experienced feed managers will move



yearling cattle through the eight steps in 21 to 32 days, while calves can be held at the appropriate energy level consistent with performance expectations. Holding the cattle at each step for a minimum of three to five days allows the rumen bacteria to adjust to the increased starch level in the diet available from the grain.

- minimizing digestive disturbances – Moving cattle too quickly onto high-grain diets can result in digestive disturbances, off-feed problems and poor performance. With step-up feeding programs these problems are minimized as cattle are adapted to the grain level in each diet for an appropriate period of time before moving to a higher level.
- allowing more predictable and consistent performance – With experience, you can become a good judge as to how a given class of cattle will perform on each diet because each ration is formulated to a specific energy/protein level.
- adaptable to least-cost ration formulation programs – Step-up feeding programs can be designed to accommodate all nutrients needed by cattle, as well as feed additives such as an ionophore (e.g. Rumensin®; refer to the next section for more details). Since the step-up programs are designed around specific nutrient levels, you can formulate diets with any available feed ingredient and take advantage of least-cost ration formulation programs.
- adaptable to bunk management programs – Step-up programs can be as simple or as detailed as you want. The goal of a good feed bunk program is to deliver the proper amount of the feed at the same time each day. This helps reduce digestive upsets or grain overload. Keep the feed bunk free of old feed and manure. Clean the bunk weekly or as required.
- helping keep cattle on full feed or *ad libitum* (free-choice) intake – One of the most difficult tasks facing feedlot managers is to ensure that cattle on full feed stay on feed and do not suffer from sub-acute acidosis. Acidosis or grain overload can arise from high-grain feeding, especially from diets that are primarily barley or wheat based. These cereal grains are rapidly digested and lead to acid conditions in the rumen. Grain overload results when too much grain is consumed in too short a time. Susceptible animals are those that are accustomed to high grain intakes or who have been off feed for a period of time (due to empty bunks, severe weather, etc.). Hungry animals will rapidly consume the high-grain diet or over-consume, which results in sub-acute acidosis and digestive upset. The cattle go off feed. Many problems with cattle going off feed are management related and can be prevented by sound bunk management programs, and the use of a good step-up program with the addition of ionophores.

TABLE 52. Example grower/feeder step-up rations (dry matter basis) and estimated gain

Feed ingredient	Feeder ration 1	Feeder ration 2	Feeder ration 3	Feeder ration 4
Barley (% DM basis)	15	25	35	40
Silage (% DM basis)	82	72	62	57
Supplement (% DM basis)	3	3	3	3
Estimated average daily gain kg/day (lb./day)*	0.68 (1.5)	0.82 (1.8)	0.90 (2.0)	1.1 (2.4)

\* Estimates are based on historical performance figures; gain may be above or below these estimates based on genetic and environmental factors.

TABLE 53. Example finisher step-up rations (dry matter basis) and estimated gain

Feed ingredient	Feeder ration 5	Feeder ration 6	Feeder ration 7	Feeder ration 8	Feeder ration 9
Barley (% DM basis)	45	55	66	75	84.5
Silage (% DM basis)	52	42	32	23	13.5
Supplement (% DM basis)	3	3	2	2	2
Estimated average daily gain kg/day (lb./day)*	1.2 (2.7)	1.3 (2.9)	1.4 (3.1)	1.45 (3.2)	1.45 (3.2)

\* Estimates are based on historical performance figures; gain may be above or below these estimates based on genetic and environmental factors.

## FEED ADDITIVES AND GROWTH PROMOTANTS

### Regulatory considerations

The federal and provincial governments are both committed to the production of safe food. The federal government regulates the use of feed additives and implants. Several departments and agencies have a role in administering these regulations.

Health Canada provides national leadership to develop health policy, enforce health regulations, promote disease prevention and enhance healthy living for all Canadians. The federal Minister of Health has total or partial responsibility for administration of the following acts related to beef safety:

- *Canadian Food Inspection Agency Act*
- *Food and Drugs Act*
- *Pest Control Products Act*
- *Feeds Act*

The Canadian Food Inspection Agency (CFIA) provides inspection and related services to four federal government departments, including Health Canada and Agriculture and Agri-Food Canada. The CFIA ([www.inspection.gc.ca](http://www.inspection.gc.ca)) administers and enforces the following acts related to beef safety:

- *Feeds Act*
- *Food and Drugs Act (as it relates to food)*
- *Health of Animals Act*
- *Meat Inspection Act*

The *Food and Drugs Act* provides the conditions and standards under which drugs are manufactured and offered for sale. It ensures drugs on the Canadian market are safe and effective and that labels contain all necessary warnings, such as toxicity, contraindications and withdrawal periods. Under the authority of the federal *Feeds Act*, the CFIA administers a national livestock feed program to verify that livestock feeds manufactured and sold in Canada or imported into Canada are safe, effective and labelled appropriately.

Under the Feed Regulations, a “medicated feed” is defined as a mixed feed that contains a medicating ingredient. A “medicating ingredient” is defined as:

A substance that is intended for use in the prevention or treatment of disease in livestock, or a substance, other than a feed, that is intended to affect the structure or any function of the body of the livestock, and that has assigned to it a drug identification number pursuant to the *Food and Drugs Act*.

For a complete listing of medicated feed ingredients, visit the CFIA website regularly for changes in the Compendium of Medicating Ingredient Brochures (<http://www.inspection.gc.ca/english/anima/feebet/mib/drguse1e.shtml#CATTLE-CALVES>), which provides information on the proper use of drugs delivered in feed.

## COMMON FEED ADDITIVES AND GROWTH PROMOTANTS

There are a number of feed additives and growth promotants that improve the health and productivity of beef cattle. The most commonly used feed additives can be grouped as follows: ionophores, antibiotics, coccidiostats, estrous suppression aids and bloat prevention aids. Growth promotants (e.g. Ralgro® and Compudose®) are used to improve growth rate and feed efficiency. Antibiotics in feed (e.g. tylosin phosphate, for prevention of liver abscesses) are used to improve health and prevent disease caused by bacteria. Coccidiostats [e.g. monensin sodium (Rumensin®), lasalocid sodium] are used to control the disease coccidiosis. Estrous suppression aids are used to prevent females from cycling. Bloat prevention aids (e.g. Bloat Guard® and Rumensin®) are used to prevent bloat in beef cattle.

Ionophores [e.g. Rumensin®, Monensin Premix (Bio Agri Mix Ltd.), Bovatec® and Posistac®] are compounds that alter the rumen micro-flora to increase the production of propionic acid in the rumen. Ionophores tend to decrease dry matter intake (DMI) by about six per cent and increase the efficiency of net energy of maintenance (NEM) of the diet by 12 per cent. The net effect is improved feed efficiency (less feed is required to maintain normal or improved rates of gain). Some ionophores may increase the average daily rates of gain.

Bloat Guard is registered as an aid in the prevention of frothy or legume bloat in cattle, as are some ionophores (e.g. Rumensin®).

Melengestrol acetate (MGA®) is a synthetic hormone, registered as a feed additive to prevent females from cycling. MGA suppresses estrus (heat) in beef heifers intended for slaughter. Feed efficiency and average daily gains may be improved. MGA is a feed additive that can be used with either an implant or ionophore.

The use of antibiotics in feed should be carried out in conjunction with good management and should not be considered as a replacement for good management. Consult a veterinarian before using antibiotics or coccidiostats in feeds.

Coccidiostats (e.g. DECOX® (decoquinate) and Amprol Feed® (amprolium)) are used to prevent coccidiosis, a disease caused by parasitic protozoa. Rumensin®, in addition to being registered for the improvement of feed efficiency, is also registered as an aid in the prevention of coccidiosis. Coccidiosis is becoming more prevalent in cattle raised in conditions of overcrowding and confinement. Symptoms of this disease are bloody scours and loss of performance. For more information, refer to the *Coccidiosis* section in the *Animal Health Management* chapter.

There are a number of growth promotants or implants currently registered for use in beef cattle in Canada (Table 54). The resulting effect for implanted cattle is an increase in energy intake above maintenance giving higher than average daily gains and better feed conversions. Rate of gain is usually enhanced more than intake and feed efficiency is also improved. Estrogenic implants increase protein content gain, whereas estradiol and trenbolone acetate (TBA) combination implants alter the protein content of gain equivalent to an increase of about 70 kg in the final shrunk body weight of an animal at slaughter (NRC 2000, 1996). Duckett et al. (1997) reported that only a portion of this response was due to increased feed intake above maintenance. The remainder was due to increased deposition of lean tissue rather than fat. Implants may be combined with some feed additives to increase performance. In some cases the combined use of feed additives and implants gives greater performance than when either type of product is used alone.

Growth promoting implants can also improve average daily gain (ADG) and feed efficiency for grass cattle. Table 54 lists the implants registered in Canada as of 2000, for use in backgrounding and finishing feedlot cattle. For details on how implants work and the correct implanting procedure, refer to the *Implanting* section in the *Calf Management from Birth to Weaning* chapter.

Several points must be considered to use implants correctly. Only implants approved for use in growing and backgrounding should be used while cattle are on grass. Use of higher-dose implants containing TBA will not enhance weight gain on pasture since the plane of nutrition is

not sufficient to allow the animal to respond to higher doses of hormone. There is also the risk of undesirable side effects (i.e. increased buller rates) if higher-dose implants are used on pasture. Finally, the use of higher-dose implants during growing phases may reduce performance in subsequent phases of production.

The expected increased live weight gain due to implants is relative to the quality and quantity of the forage that the animal consumes. As forage quality (pasture quality) increases from low to high, so does the gain response from the implant. When animals are on a low plane of nutrition because of poor pasture quality [ADG of 0.45 to 0.57 kg/day (1.0 to 1.25 lb./day)], the response to implants is poor. In these situations, the use of growth promontant implants may be of little value.

Implants should not be administered within 60 days of a previous implant. The systemic levels of hormone do not start to decrease until after 60 days. Therefore, reimplanting before this point may lead to side effects such as diminished performance, increased riding activity and vaginal prolapses in heifers. Consequently, it is important to know as much history about recently purchased cattle as possible. A single implant is sufficient to last an entire grazing season, unless the forage quality is excellent or the cattle are supplemented later in the season. In this case, consider using a longer lasting product such as Compudose.

There appears to be a difference in dry matter intake response between estrogen (Ralgro, Synovex<sup>®</sup> and Component<sup>®</sup>) and trenbolone acetate plus estrogen (Revalor<sup>®</sup> and Synovex Plus<sup>®</sup>) implants. Data of Anderson and Botts (1995) showed a 5.7 or 6.64 per cent increase in intake response to either estrogen or trenbolone acetate + estrogen implants. A summary of six trials by Duckett et al. (1997) showed a 2.5 per cent increase in dry matter intake of trenbolone acetate + estrogen over strong estrogen implants. All of the products in each type of implant work well when used at the correct time during the appropriate stage of production. Producers are well advised to spend time and effort learning how to use implants properly, instead of trying to decide which product outperforms the others in its type. Implants work well when used correctly.

Always follow the label directions and observe pre-slaughter withdrawal periods when using feed additives or implants. A livestock nutritionist or veterinarian should be consulted before using any of these products in a feeding program.

For more information on administering medicated feeds, consider taking the *Cattle Medicine – Responsible Use Course*. This course is designed for beef and dairy cattlemen and can be obtained from: *Alberta Beef Quality Starts Here* c/o Alberta Beef Producers. Phone: 1-866-242-7404.

## FEED ADDITIVES AND ALTERNATIVE BEEF PRODUCTION SYSTEMS

Consumers are demanding to know how their food is produced and some of them are prepared to pay a premium for organic or natural products. This is creating some niche market opportunities in the beef industry. Certified organic beef, natural beef and certified hormone-free beef have been available in the past, but with today's larger numbers of health-conscious and wealthy consumers, the potential for growing and sustaining these niche markets may be enhanced.

Organic is a registered term and is defined as a product that has been certified organic by a certifying body. In July 1999, the Canadian Organic Advisory Board (COAB) approved national standards for certified organic beef production in Canada. Hormonal growth promotants, antibiotics and other feed additives used to promote growth are not permitted under these standards. Animals treated with non-permitted substances must be removed from the organic category and may no longer be marketed via this method. Slaughter livestock must be born and raised in a certified organic production unit. COAB standards are designed to be a set of minimum standards for certification and may include housing requirements, animal origin and yearly certification fees.

The definition of natural beef varies from producer to producer and is not a registered term. Natural tends to designate beef that has not been implanted with hormonal growth implants or treated with antibiotics. Natural beef has no formal certification process.



The certified hormone-free beef program is administered by the Canadian Food Inspection Agency (CFIA) and is designed to guarantee that eligible beef animals have never been treated with hormonal growth promotants. In 1989, the European Union (EU) banned the use of hormonal growth promotants, cutting off exports of beef products from North America. Animals that have been inspected and certified that they are eligible for this program may be slaughtered and exported to the European Union.

Certified hormone-free beef must come from a farm certified by the CFIA and a CFIA-accredited

veterinarian. The producer enrolls and each year fills out an application form and declaration. CFIA eartags are issued to the producer and an inventory registration is completed, with a tag for each calf. The calves are monitored by an accredited veterinarian and at least 10 per cent of the animals must be inspected. A transfer certificate must be filled out any time the animals are transferred to another certified site. A veterinarian again inspects the animals within three months of slaughter. At this time urine and feed samples are taken for analysis to verify that the animal is free of hormonal growth promotants and antibiotics.

TABLE 54. Growth implants registered for use in Canadian weaned calves and cattle

Registered products	Active ingredients	Effective time (days)	Grass cattle	Backgrounding cattle		Feedlot cattle		Breeding cattle	
				Steers <360 kg (800 lb.)	Heifers <360 kg (800 lb.)	Steers	Heifers	Bulls	Heifers
<b>Ralgro®</b>									
Ralgro FE72	72 mg Zeranol	~	Yes	No	No	Yes	No	No	No
<b>Synovex®</b>									
Synovex-S	200 mg Pr + 20 mg EB	~ 120	Yes	Yes	Yes	Yes	No	No	No
Synovex-H	200 mg T + 20 mg EB	~ 120	Yes	No	Yes	No	Yes	No	No
Synovex Plus	200 mg TBA + 20 mg EB	~ 120	No	No	No	Yes	Yes	No	No
<b>Component®</b>									
Component E-H	200 mg T + 20 mg EB	~ 120	Yes	No	>186 - 454 kg (410 - 800 lb.)	No	>186 - 454 kg 410 - 800 lb.	No	No
Component E-S	200 mg Pr + 20 mg EB	~ 120	Yes	186 - 454 kg (410 - 1,000 lb.)	No	186 - 454 kg (410 - 1,000 lb.)	No	No	No
Component TE-S	120 mg TBA + 24 mg E17β	~ 120	No	No	No	250 - 454 kg (550 - 1,000 lb.)	No	No	No
<b>Compudose®</b>									
Compudose	24 mg E17β	~ 168	>260 kg (575 lb.)	>260 kg (575 lb.)	>260 kg (575 lb.)	>260 kg (575 lb.)	> 260 kg (575 lb.)	No	No
<b>Revalor®</b>									
Revalor-S	120 mg TBA + 24 mg E17β	~ 120	No	No	No	250 - 454 kg (550 - 1,000 lb.)	No	No	No
Revalor-H	140 mg TBA + 14 mg E17β	~ 120	No	No	No	No	>299 kg (660 lb.)	No	No

Abbreviations: E17β- Estradiol (E)-17beta (β), the active form of estradiol; EB - Estradiol benzoate (activity = 72% the activity of E17β); ~ = approximate; TBA - Trenbolone acetate (8 - 10 times the anabolic activity of testosterone); Pr - Progesterone; T - Testosterone; Zeranol = 1/3 the anabolic activity of E17β.  
Source: Dorin (2000)

As a producer, if you are considering or are involved in an organic beef or a natural beef production value chain, check with the certifying bodies for each program about what feed additives and growth promotants are allowed or banned. Follow the guidelines established by the program that you are involved in. Remember that not using growth promotants results in slower daily rates of gain and decreased feed efficiency. The end result is that animals require more feed and need to be kept on feed for a longer period of time to achieve the same desired slaughter weight. This increases your production costs. These increased costs should be accounted for in determining your break-even selling price.

## Winter Feeding of Bulls

Winter is the time to properly condition bulls for the coming spring and summer breeding season. Proper conditioning is important because bull fertility has a major impact on whether a cow will conceive and calve early or late in the calving season and influences calf weaning weight and uniformity. In addition, because of the high (1:25 to 1:50) bull:cow ratio used for natural service, the fertility of the herd bull is much more important than that of any individual cow. Indeed, for the beef breeder, bull fertility is 5 to 10 times more important than growth performance and product quality, respectively.

Nutrition is the main factor affecting proper conditioning of bulls and their fertility. How can we manage bulls so that they do not have impaired sex drive (libido) due to being either too fat or too thin? The target of the winter-feeding program is to allow the bulls to reach a good to very good body condition score of 3 to 3.5 at breeding time. (Refer to the *Herd Management* chapter to learn about body condition scoring). Bulls that have been out on pasture with the breeding herd during the summer might be thin in the fall. Growth requirements must be met before any improvement in condition can take place.

Once the bull has passed the breeding evaluation, the feeding program to attain a body condition score of 3 to 3.5 involves knowing the rate of gain that the bulls should achieve in order to reach the desired mature weight.

Table 55 details target weights and daily gains necessary for growing bulls to achieve their full breeding potential. Diet recommendations for growing bulls and not finishing are designed to result in a growth rate of 1.4 to 1.6 kg/day (3.0 to 3.5 lb./day).

The following are targets to aim for when balancing rations for young growing bulls:

- dry matter (DM) intake – 2.7 per cent of body weight at 227 kg (500 lb.); 2.5 per cent of body weight at 544 kg (1,200 lb.)
- energy, expressed as per cent total digestible nutrients (TDN) – 67.5 to 68.5 per cent (DM basis)
- crude protein – 13.5 to 14 per cent (DM basis)
- calcium – 0.55 per cent (DM basis)
- phosphorus – 0.40 per cent (DM basis)
- calcium:phosphorus ratio – within the range of 2:1 to 7:1
- ensure that all trace minerals and vitamins A, D and E are at adequate levels

Use a good quality alfalfa-grass hay or cereal silage and coarse ground or rolled barley or whole oats for feeding growing bulls. A protein supplement may be required, or 0.9 to 1.4 kg (2 to 3 lb.) of feed peas or lentils may be used to supplement protein. Feed an ionophore such as Rumensin to improve feed efficiency and to reduce the potential of bloat occurring. Feeding the grain/supplement mixture in two equal portions each day is another practice to reduce the risk of bloat. The above growing ration recommendations should provide an excellent opportunity for development of the frame and muscle of growing bulls.

Adequate nutrition is equally important for young bulls after the breeding season for continued growth, development and lifetime breeding potential. After the breeding season, the growth rate should be about 1 kg (2 lb.) per day depending on the condition of the bull. Winter feeding of bulls that are two or more years old at breeding should be geared to reach the optimum breeding condition when they are put with the cows. If you calve in January-February,

supplementary winter feeding of thin bulls (score of 2 or less) for gains as in Table 55 may be necessary. On the other hand, if breeding to calve in April-May, it may be possible to winter feed the same bulls at nearer a maintenance level and depend on spring grass to bring up the condition by breeding time. Judgement on the exact level of winter feeding needed depends on the condition of the bull as he goes into the winter. If he is in good condition (score of 3 or more), you should feed for lower winter gains aimed to hold his condition so that he will not become too fat by breeding time.

Bulls should be at a relatively high nutritional level prior to turnout in the spring, as they need to have an energy reserve when they start breeding.

There is no advantage to shooting for high rates of gain in growing bulls by feeding large amounts of grain. Do not coerce growing bulls to attain their maximum mature weight by overfeeding. Indeed, bulls that attain a moderate body condition score at the target weight for their age and their breed have fewer breeding problems than bulls that have been overfed and are too fat for their weight.

TABLE 55. Target weights and daily gains for growing bulls

Mature bull weight in moderate condition kg (lb.)	Target weight – kg (lb.)			Minimum daily gain – kg (lb.)	
	Weaning at 200 days of age <sup>1</sup>	14 months for breeding <sup>2</sup>	At 24 months of age <sup>3</sup>	Weaning to breeding	Yearling to 24 months
798 (1,760)	270 (595)	500 (1,100)	748 (1,650)	1.4 (3.0)	0.8 (1.8)
898 (1,980)	279 (615)	528 (1,166)	800 (1,760)	1.4 (3.0)	0.9 (2.0)
998 (2,200)	290 (640)	560 (1,232)	858 (1,892)	1.5(3.3)	1.0 (2.2)
1,098 (2,420)	285 (630)	588 (1,298)	918 (2,024)	1.6 (3.5)	1.1 (2.4)
1,198 (2,640)	310 (685)	620 (1,364)	980 (2,156)	1.6 (3.5)	1.2 (2.6)

\*1 Estimated as 26 to 34% of mature bull weight

\*2 Estimated as 52 to 62% of mature bull weight

\*3 Estimated as 82 to 94% of mature bull weight

Sources: Martin et al. (1993), CowBytes® (1999) program

Two-year-old bulls should have already gained most of their mature size by the breeding season. Therefore, their ration is not quite so critical. During the breeding season they will probably need to gain only 0.5 kg (1 lb.) per day. An active two-year-old bull will need about 13 to 16 kg DM (30 to 35 lb. DM) of forage or more, depending on the quality of the forage, plus 2 to 3 kg (5 to 7 lb.) of grain to build up an energy reserve for breeding. Older bulls require diets with adequate levels of vitamin A (about 9 g (0.3 oz.) of vitamin ADE) per day as it is necessary for semen production. If older bulls have been wintered in good condition, 2 to 3 kg (5 to 7 lb.) of grain may be added to their diet to build the desired energy reserve for breeding.

Provide adequate feeder space for all the bulls to eat at the same time. Large bulls need about 0.6 m (2 ft.) of bunk space per bull. Make sure all

the bulls have gathered at the feeding area before feeding any grain. This makes sure that each bull gets his fair share and it should prevent overeating by a few bulls.

Exercise is also important in keeping bulls healthy and thrifty. The easiest way of providing exercise is to allow them to run in a well-fenced pasture. Allow about 0.8 ha (2 ac.) per bull, with a large enclosure where several bulls can run together. Placing feed and water at opposite ends of the pasture forces the bulls to exercise.

Good bulls represent a major investment and are critical to the success of a breeding program. Proper care over the winter and before the breeding season helps ensure fertile, active bulls during the breeding season.

## Grazing Management

Most of Alberta has a short grazing season, but it is vital to profitable cow-calf production. By taking advantage of unique conditions and using specialized management, a few Alberta cow-calf operations can graze their herds 12 months of the year. These situations depend on mild weather and good forage resources during the winter grazing period. Most southern Alberta operations practice some winter grazing within a nine to 10 month grazing season. Cow-calf operations in central and northern Alberta have less opportunity for winter grazing because winters are harsh, with increased snow cover and colder temperatures. Their grazing seasons normally begin in the spring and end five to seven months later.

In spite of the short summer grazing season, the nutrition of the cow and calf during this period is critically important to the cow-calf producer. The cow's success at weaning a heavy calf, her rebreeding capability and her condition before the winter-feeding period are related to the quality and quantity of pasture available during the grazing season.

While drought, fire, grasshoppers and rodents are considered the perennial enemies of farm managers, what usually robs them of adequate forage and pasture resources is inadequate management. Poor pasture management that results in higher costs and lower margins can make a cow-calf operation unprofitable.

*High quality pasture contributes to rebreeding and weaning performance.*



## Nutrition on Pasture

### COWS AND PLANTS

Cool-season grasses [grass species that grow and reproduce best when temperatures are below 29 C (84 F)], forbs (herbaceous plants with broad leaves) and a few shrubs dominate Alberta pastures. Cows eat most of these plants, but they will show an obvious preference for a few. Without management they will eat preferred plants exclusively, ignoring the other plants. If the situation is not controlled, grazing will create two conditions on the pasture: overgrazed preferred plants and undergrazed rejected plants.

Undergrazed plants have a competitive advantage. With their foliage intact, they can spread out and reproduce more effectively than the grazed plants. In a short time, sometimes within one grazing season, the pasture can be changed from one dominated by productive, preferred plants to one of low productivity dominated by unpreferred plants.

### FORAGE AVAILABILITY

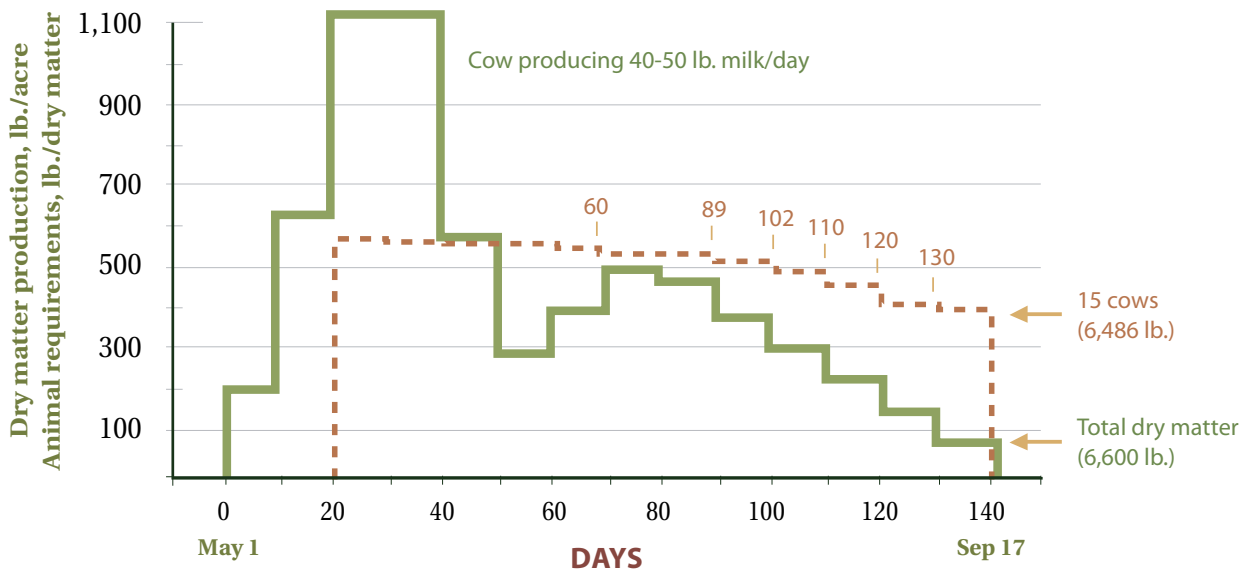
Cool-season grasses have a typical growth cycle during the grazing season. Growth starts early in the spring, when the soils are still cool. Some grasses may even grow under the snow (e.g. creeping red fescue). Growth and development are rapid, peaking in June (Figure 46). During the summer, many cool-season grasses have a short period of dormancy when growth slows down because the enzyme systems they use to capture energy from sunlight are not well adapted to the hot summer days. Production above ground declines as the plant completes its reproductive cycle, sets its seeds and begins storing winter reserves in its roots.

The plant's cycle of growth, development and maturity, and/or death creates an annual cycle of available forage. The lowest amounts of forage are available during the late fall and winter. Forage is increasingly available as growth initiates in the spring and continues through the early summer and declines in availability through the late summer and fall as the leaves die (Figure 46).



The cow's demand for forage cycles through the same period, but it does not match the cycle of forage availability. During the spring and early summer, she may not require as much forage as the pasture is capable of producing. Most pasture managers recognize this small surplus of grass in a field as storage for later use.

Usually, cows and calves are let into their spring pasture just prior to the period of maximum forage production (Figure 46). This coincides with the cow's highest demand for forage. The cow's demand for food remains relatively stable throughout the growing season, but because of the normal decline in productivity of the forage plants, her demand may exceed the amount of forage available, creating a deficit. If the pasture manager has been careful and the field has not been over-stocked, the surplus forage produced during the spring growth period will be available for use during the period of deficit (Figure 46).



**FIGURE 46.** Forage availability and demand by cattle

Note: Dry matter production and daily dry matter feed requirements averaged over 10-day intervals through the growing season. Adapted from: Walton (1983)

## FORAGE QUALITY

Forage quality is a major issue for pasture managers in modern cow-calf operations. A century ago, most pasture was the natural rangeland of Alberta, unfenced and wild. While a few traditional operations still exist, today's rancher has considerably more technology and investment in pasture resources.

Some pastures are monocultures, where only one species predominates. Examples of such pastures include annual cereal crops such as winter wheat, fall rye, winter triticale and perennial cereal ryegrass, corn and other crops such as turnips and kale. Perennial cereal ryegrass and its close

relatives, Italian and Westerwolds ryegrass, are not winter hardy enough to survive more than one or two growing seasons in Alberta. Consequently they are treated as annuals here. Some irrigated fields in southern Alberta have been sown to monocultures of perennial grass, the favourite being meadow brome grass. However, most perennial pastures are a diverse mixture of grasses and forbs. Natural or native pastures are made up of species that have evolved to survive and reproduce within the limits imposed in the different climatic and soil zones of Alberta. Domesticated, seeded or tame pastures usually include mixtures of legumes, such as alfalfa or clover and various cultivated grasses.

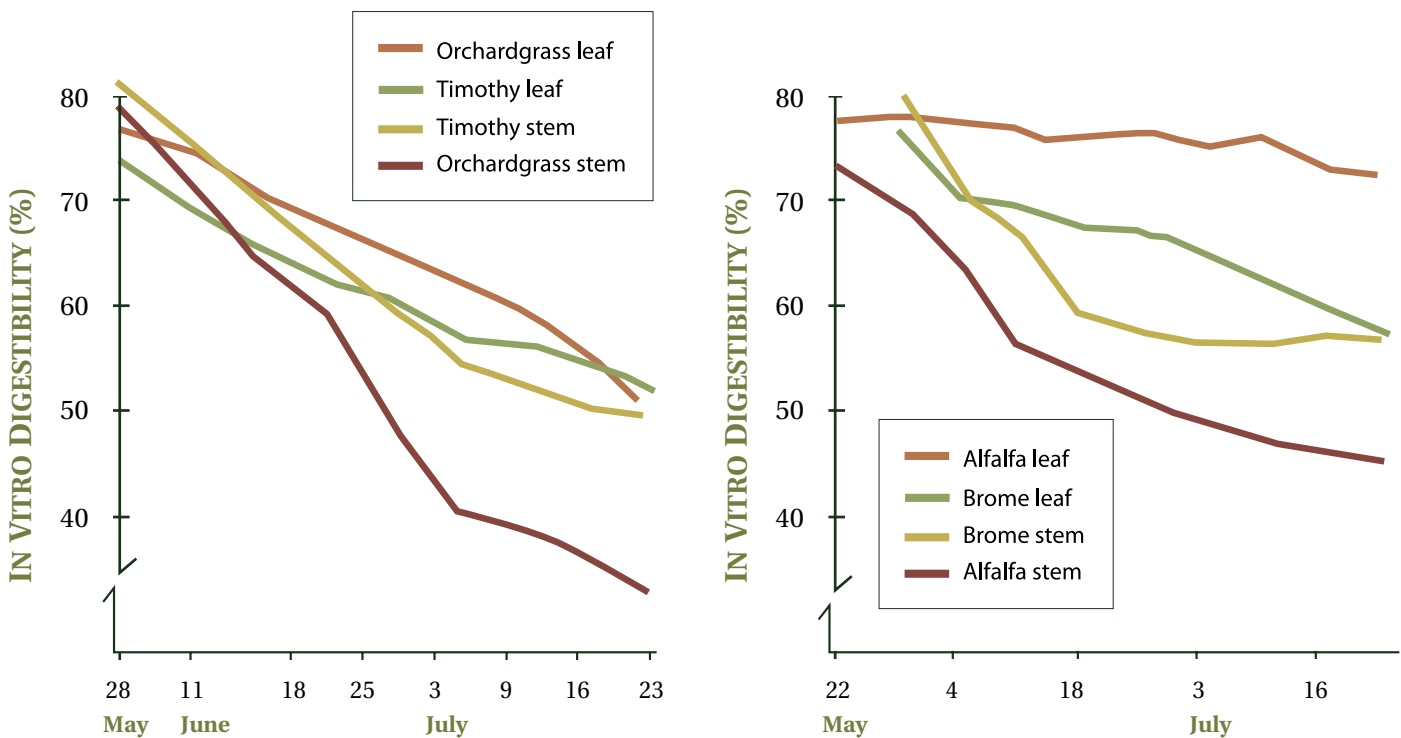
Generally, as the growing season progresses the digestibility and quality of the forage declines. The rate of decline differs between plant parts; stems decline in forage quality sooner and to a greater degree than leaves. The rate of decline also varies with the plant species. Figure 47 shows examples of species that are commonly seeded in monocultures and in mixed pastures throughout Alberta. The decline in quality is a natural development in plants. It is a consequence of the increasing amounts of cell wall, or fibre, produced to support their leaves and flowering stems.

Cows grazing mixed pasture are presented with quite a menu, compared to those grazing a monoculture. However, even a monoculture can give quite a choice of things to eat. Being selective, cows will eat certain plants and even show a preference for particular plant parts of one plant species at different times during the grazing season. Depending on a cows location in the pasture, how many other cows are competing to find the same food and the progressive development of the plants, an individual cow may find less or more of her preferred food. Her preferences and the abundance or lack of preferred foods lead directly to changes in her daily dry matter intake.

On pasture, as well as in the barn, a cow's intake levels are highly correlated with the digestibility of the food she eats. If she has any choice, she will eat the more digestible forage, even if it is in short supply and reduce her intake of less digestible forages. With the seasonal decline in digestibility of the pasture, the cow's intake falls and productivity decreases, as measured by milk output, weight gain and body condition.

Other forage quality issues that are unique to pastures include the propensity of some plants to cause digestive or metabolic disorders, the availability of minerals (deficiencies and toxicities) and vitamins, and the prevalence of poisonous or harmful plants.

A number of plants can cause digestive or metabolic disorders. Bloat (excessive ruminal tympany) can be caused by rapidly digesting forages such as immature alfalfa, wheat or fall rye. Photosensitivity (sunburn and peeling skin) has been reported in cattle grazing cicer milkvetch and buckwheat. Nitrate poisoning has been reported, usually after cattle have been grazing hail, drought or frost damaged crops.



**Figure 47.** Changes in the digestibility of leaves and stems of grasses and alfalfa during the growing season

Note: In vitro digestibility is measured using rumen fluid in test tubes, rather than in the animal's stomach (in vivo). Adapted from: van Soest (1994, p. 78-79)

Mineral and vitamin deficiencies are not common, but a few cases are reported every year. Many of Alberta's soils are deficient in important trace minerals such as cobalt, copper, zinc or selenium. Deficiencies in vitamins, such as vitamin A, can occur in cows grazing crop aftermath or swaths during the late fall or winter. Consequently, providing a good quality mineral supplement and vitamins to cattle on pasture is a common practice. One of the most common maladies, grass tetany (hypomagnesemia), is caused by a deficiency in magnesium. It occurs in lactating cows grazing on actively growing, early spring pastures.

Toxicities are very rare. However, a few plants contain some very highly toxic compounds. Solanine is a toxin found in green tubers and the green tops of potatoes. Small doses are fatal. Cattle should not graze after-harvest potato fields. Older cultivars of sorghum or Sudan grass, sometimes grown as a silage crop, contain a cyanogenic glycoside that accumulates when the plant is stressed by frost or lack of sunlight. Other plants that normally contain cyanogenic glycosidic compounds and that are common to rare on Alberta's rangelands, include the chokecherry and seaside arrow grass. These compounds convert to hydrocyanic acid or cyanide, which is toxic in minute quantities.

### PASTURE MANAGEMENT

Managing pastures for cow-calf production is complicated because results may not be immediate and the costs can be hidden. Pasture management can be divided into three specialties: forage management, livestock management and grazing management. Most decisions made with respect to these three specialties are integrated, that is, you usually cannot make a change in one without inducing change in the other two.

For example, assume a livestock management decision has been made to calve earlier in the year, in February instead of May. This decision induces a change in at least three areas of forage management. First, the quantity and quality of stored forage for cows in their third trimester and early lactation must be increased because the demand occurs in mid-winter and stored feed is

required for at least an additional two months. Second, the quantity and quality of summer pasture needs to increase to accommodate the additional demand from calves that 20 to 40 kg (45 to 90 lb.) heavier. And third, the late season fall pastures may need improvement to maintain or increase the cow's body condition and prepare her for the next year's cycle. While forage and livestock management are focused on inducing change to improve production in their respective areas, grazing management is the means by which we balance the changes, by making changes to control the frequency and severity of defoliation and livestock impact.

### FORAGE MANAGEMENT

Areas specifically used for grazing in Alberta include land seeded with domestic (tame) grass and legume forage species, native prairie rangeland, forested rangelands, annual crops seeded for spring, fall or winter grazing and crop aftermath. Local or regional expertise is required to understand the range of forages available, their quantity and quality throughout the year, and the management necessary to obtain the greatest value from them.

Managers who are serious about improving forage production and quality can obtain specific information from a number of reliable sources. The *Alberta Forage Manual* and related publications from Alberta Agriculture and Food (AF) provide an excellent summary of information for seeding, growing and producing forages in the province. The *Range Health Guides*, available from Alberta Sustainable Resource Development, provide tools and references for evaluating native

*Pasture quality declines as the plants mature.*



pastures and options to improve them. More general information is available from federal agencies, such as Prairie Farm Rehabilitation Administration (PFRA), while specific information on sensitive pasturelands (e.g. riparian areas) may be obtained from conservation agencies (e.g. Cows and Fish, Nature Conservancy).

## SEEDING AND ESTABLISHMENT

“Well sown, half-grown.” The single most important principle for establishing a new pasture is to ensure that the seed you plant has a competitive advantage over everything else.

Thin stands are most likely caused by seeding too deeply, using an insufficient seeding rate and too much competition from weeds or companion crops. Thus three things must be managed:

- the competition (previous crop, weeds or companion crops) must be eliminated, or at least reduced to a level where it will not interfere with germination and emergence
- a species or mixture adapted to the local soil and climatic conditions should be selected
- seeding rates (based on pure live seed), seedbed preparation and seeding techniques should not limit germination and emergence

As a general rule, domesticated grasses and legumes should be seeded within the top 2.5 cm (1 in.) of the soil surface. Forage seeds are small and they will not emerge if seeded too deeply. Seeding rates should be adjusted to give a seeding density between 50 and 70 pure live seeds (PLS) per metre (15 and 26 PLS/ft.) of row, which translates to between 300 and 450 PLS/m<sup>2</sup> (26 and 40 PLS/ft.<sup>2</sup>). Higher seeding

*A firm, clean seedbed improves germination of forage crops.*



densities may be required where competition for light and moisture is expected and where there is a potential of poor seed-to-soil contact.

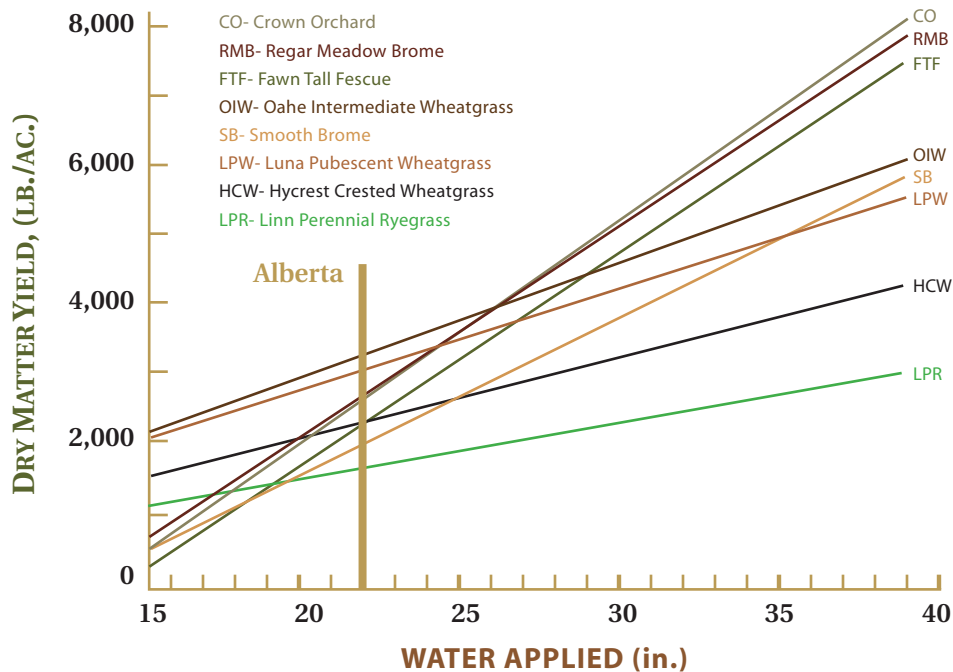
## FORAGE NUTRIENT REQUIREMENTS

The soils of Alberta do not provide plants with all of their required nutrients. Nutrients that are available are not usually found in sufficient quantities to allow plants to achieve their maximum potential for growth. Under natural conditions, rates of replenishment of some recyclable nutrients, such as water or nitrogen, may be low and in the case of non-recycling micronutrients, such as selenium, copper or zinc, supplies may be nonexistent. Plants adapt to low nutrient levels and may not show an immediate response if a nutrient that is limiting becomes abundant for a short period. Consequently, most cow-calf producers have compromised by supplying non-recycling nutrients to their animals in the form of salt and mineral supplements on pasture, and letting nature run its course with the recyclables available for plant growth. Unfortunately, this means that operations must live within the constraints of the local environment.

The most limiting nutrient is water. Plants and animals have developed adaptations to cope with water shortage or abundance. Plants require water to grow or produce a forage yield. Domesticated grass species may be separated on the basis of their growth response to available water. Figure 48 shows the response of domestic forages (water production function) to various levels of applied water. The vertical line represents the long-term maximum rainfall that Alberta receives over the perennial growing season from April 1 to November 30 [560 mm (22 in.)]. The area to the left of the Alberta line shows the plants' yield responses to water levels below 560 mm (22 in.). The area to the right of the line shows the yield responses to levels above 560 mm.

The average long-term rainfall for the Alberta green Zone (colour area on Figure 49) for April to November period is 396 mm (15.5 in.), with a range of 242 mm (9.5 in.) (minimum) to 581 mm (22.8 in.) (maximum). Many parts of the province typically receive precipitation levels that are either higher or lower than this average. Water availability for forages in Alberta is correlated with precipitation levels from April to November (Figure 49).





**Figure 48.** Water response functions for grasses (sunlight, temperature and nutrients not limiting)

Producers can easily decide which plant species are appropriate choices for pasture or hay production in their region by simply comparing forage species response curves with available water supplies.

Have the soil in each field tested for nutrient levels and the presence of limiting factors such as acidity or salts. Proper soil fertility can greatly increase pasture production when plant density and vigour are good and moisture is not limiting. Use the fertility recommendations that are specific for the field. Generalized recommendations are rarely successful or economic in the long term. Fertility and plant response will vary with the soil limitations, type of crop (grass, legume or a mixture of both), age of the stand, previous treatments (such as manure applications) and available moisture.

## WEED CONTROL

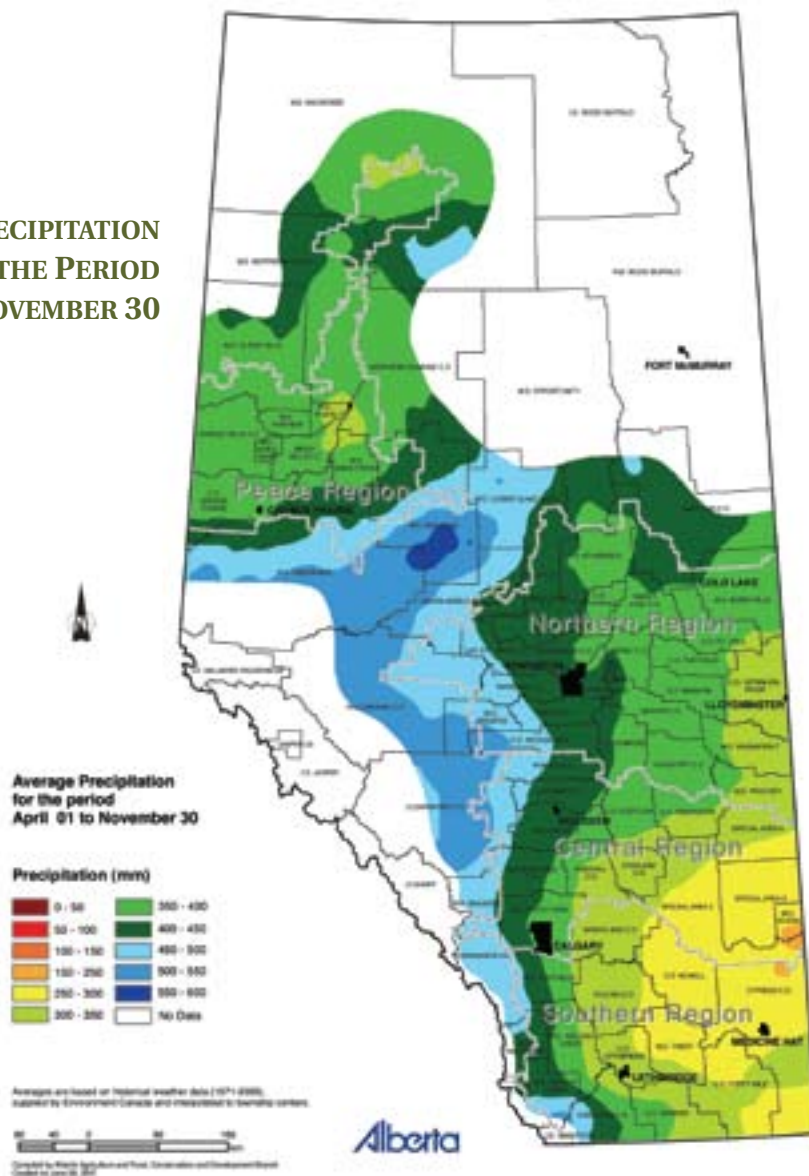
Having weeds in newly seeded stands is normal. The combination of seedbed preparation and seeding is quite conducive to the germination and emergence of legions of weed seeds that may have accumulated in the soil. The secret is early control by mowing and spraying.

Weeds also encroach on pastures as they age. Dandelion, quackgrass and Canada thistle are the most common, found in virtually every region of Alberta. They survive because they have growth and reproductive strategies that keep their vegetative parts from being consumed by livestock. Dandelion and quackgrass grow close to the ground while thistle has unpalatable barbs. Small infestations are normal. Abundance is usually a symptom of inadequate pasture management.

Weeds in established stands should be controlled as soon as they are noticed. Small infestations should be noted on a map or global positioning system (GPS) unit and revisited annually. If the infestations are smaller than 0.5 ha (1.2 ac), they can be spot-sprayed or hand-rogued. A combination of grazing, spraying and even re-seeding may be needed to control larger infestations.

Numerous weed guides exist to help identify problem weeds. For current weed control options, consult Alberta Agriculture and Food's (AF) *Crop Protection book* (the "Blue Book"). It is available from AF, reputable herbicide dealers or licensed applicators.

**NORMAL PRECIPITATION  
FOR THE PERIOD  
APRIL 1 TO NOVEMBER 30**



**Figure 49.** Average precipitation for forage in Alberta

**ANNUAL CROPS**

Annual crops make excellent pasture crops. Growing annuals for pasture is generally more expensive than using perennials for pasture. However, annuals can provide producers with the ability to graze crops when they would traditionally be feeding stored feeds. This reduces costs for harvesting, handling, feeding and manure management. Annuals give producers more flexibility within their livestock operation.

Annual crops are used to supplement perennial pastures, to extend the grazing season (both spring and fall), as emergency pasture during drought

or as stockpiled feed for winter grazing. The most prevalent crops used for grazing are cereal crops; either winter or spring. They are the least expensive to grow, widely adapted, easy to manage, commonly available and generally very productive. This makes them a low-risk annual forage crop.

Spring cereals are not best adapted to summer grazing as they produce the majority of their growth early in the season and have poorer regrowth than some crops. They are hard to manage and maintain in their vegetative state for good pasture purposes. They also tend to produce stem and seed heads that are not preferred by

grazing livestock. The most common spring cereals used for grazing are oats, barley and triticale. Occasionally, hail or drought-damaged crops are grazed.

Winter cereals seeded in the spring tend to be more productive during the summer months. They require a vernalization period to produce seed, so when spring-seeded these crops remain in the vegetative state and produce only leaf material. This makes them very easy to manage for grazing. Winter cereals are more productive under intensive grazing management systems than when grazed continually. The quality of the winter cereals can easily be 20 per cent protein and 75 per cent digestibility. The most common winter cereals for grazing are fall rye, winter triticale and winter wheat.

Ryegrass is another common annual used for grazing. Ryegrass is not very drought-tolerant and should not be considered in areas of low moisture. Ryegrass grows and regrows very quickly, which makes it ideal as a pasture grass. Some ryegrasses are short-lived perennials and some are annuals. In Western Canada, they are all annuals since they tend not to have sufficient winter hardiness to withstand the winters. Ryegrass is small seeded like most grasses and when seeded in the spring, it grows slowly initially until it becomes established and then it grows very quickly. When managed under an intensive management system, ryegrass can be very productive. The fact that it has little or no dormancy makes ryegrass useful for extending the grazing season, as it continues to grow and maintains its quality well into the fall.

*Annual crops can provide high quality pasture.*



Seeding rates recommended for pastured annuals are slightly higher (25 per cent) than those used for crop production. The increased plant density should improve the growth and regrowth potential as a forage crop.

Annual crop pastures should be divided into smaller paddocks with temporary fences (e.g. electric fences) to reduce losses from trampling. Water needs to be readily accessible from each paddock. Consequently, the cost of annual pasture is often higher than for perennial pasture.

Weed control may be critical for establishment of an annual pasture, but some herbicides have grazing restrictions. It's wise to consult a herbicide dealer or licensed applicator before seeding.

Fertility management is also critical because high rates of applied nitrogen can result in toxic levels of nitrate accumulating in the forage. This condition may also occur during a drought or after frosts or hail. Have the feed tested for nitrates.

## SWATH GRAZING

Swath grazing can be used to extend the grazing season and reduce costs for feed, labour, manure handling and corral cleaning. Research at the Lacombe Research Centre has shown that swath grazing can reduce the cost of wintering cows by 50 per cent through reduction in forage harvesting, winter-feeding and corral cleaning costs.

For swath grazing, annual cereals are seeded in mid-May to early June. It is then swathed from late August to mid-September when the crop reaches the soft to late dough stage and before killing frosts. The swaths are left in the field for the cattle to graze during the winter.

Beef cattle may be able to obtain all or part of their winter feed requirements through swath grazing. For swath grazing to be successful, good management is necessary so that the cattle are healthy and maintain adequate body condition. Feed fencing, water sources and shelter are all important elements that need to be carefully planned when developing a swath grazing program. For more detailed information, refer to Agdex 420/56-2 *Swath Grazing in Western Canada: An Introduction*, available from AF as a printed publication or at [www.agric.gov.ab.ca](http://www.agric.gov.ab.ca) (Ropin' the Web).





Swath grazing extends the grazing season.



Use electric fencing to control access.

Mature, dry beef cows (four to seven months pregnant) that are at a body condition score of 2.5 to 3 should be used for swath grazing. Caution is required when swath grazing calves, young cows, thin cows or cows with calves because they need higher levels of energy, protein and management, as well as better quality feed than dry, mature cows. Consider providing supplemental feed and shelter to animals with higher management needs when swath grazing.

Controlling cattle access to the swaths is one of the most challenging and important factors in a successful swath grazing program. If the cattle are not confined they will only graze portions of the swaths. Portable electric fences can be used to restrict access (refer to the *Pasture Fencing* section in the *Handling Facilities and Fencing* chapter). These fences help to improve feed utilization by regulating the quantity of feed being consumed. They also help to reduce wastage by preventing livestock from trampling swaths over a larger area.

Table 56 provides a summary of the swath grazing experiences at Agriculture and Agri-Food Canada's Research Centres at Melfort, Saskatchewan and Lacombe, Alberta. Heavy snow conditions at Melfort in all years made it difficult for high swath grazing utilization. At Lacombe, there were some years where there was virtually no snow until January. The result was the cows were able to make excellent use of the swathed crop. In both locations, cows plus calves were able to clean up all available swathed material the following spring before spring seeding. The nursing cows were supplemented with extra silage or grain to meet their nutritional requirements.

The following tips can help you manage a successful swath grazing program:

- Cows can graze through 0.6 m (2 ft.) of soft snow. If the snow becomes too hard or too deep, open up the swath by driving a tractor down the swath or blading snow off the swath.
- Placing a portable fence across the swaths also helps by exposing the ends of the swath, as the cows will see the continuation of the swath after each fence move.
  - Energizer type and size play a major role in the effectiveness of an electric fence during the winter. A 110-volt energizer is recommended for reliability and low maintenance if electric fencing is being used in the winter to regulate swath grazing.
- Straw bedding can be used as part of the wintering ration, thus extending the use of the swaths. Cows may waste up to 25 per cent of the available swaths by using the material for bedding.
- Assess potential conflicts with wildlife before swath grazing. Wildlife problems tend to be the greatest in the Grey and Black soil zones. Deer, elk, ducks and geese can trample and defecate on swaths left for grazing.
  - Try to scare the deer and elk away at the start of the swath grazing season, before they get into the habit of eating swaths.
  - If wildlife losses are a major concern, other feeding systems should be considered.



TABLE 56. Swath grazing at two locations in Western Canada

Timing of swath grazing	Grazing Days	Cross-bred cows (number/acre)	Crop yield (lb. DM/acre)	Grazing (days/acre)
<b>Oat swath grazing at AAFC Melford Research Farm</b>				
November 3 to December 21/94	48	2.6	7,179	125*
November 21/95 to January 8/96	48	2.25	6,750	108*
November 21/96 to January 9/97	48	2.25	7,624	108*
<b>Barley swath grazing at Lacombe Research Centre</b>				
November 19/97 to January 30/98	70	4.0	7,004	297
December 1/98 to February 17/99	79	2.1	4,508	167
November 8/99 to March 2/00	115	2.3	6,446	296
November 15/00 to February 27/01	104	2.3	7,660	197
December 3/01 to February 20/02	86	1.7	7,659	148
November 1/02 to February 20/03	111	2.7	9,678	301
November 21/03 to February 23/04	94	2.1	8,130	194
<b>Oat swath grazing at Lacombe Research Centre</b>				
November 1/02 to February 20/03	111	2.6	7,011	288
November 21/03 to February 23/04	94	1.9	8,130	176

\*Melfort data refers only to winter grazing days. Extra grazing days obtained from spring grazing are not included.

It is important to know the feed quality of the swath to estimate the nutrient levels available and to determine the type and amount of supplemental feed needed. Do feed testing of the swaths in early October. Test the swaths again in March if spring grazing is being planned. Take 10 to 20 random samples from across the field. The combined sample must be representative of the crop being grazed. The sample can be analyzed at any accredited laboratory. The analysis should include fibre content, projected energy levels and protein levels, as well as calcium, phosphorus, potassium, sodium, magnesium and nitrate levels. The results can then be used to balance the nutrients from swath grazing with a supplemental ration.

Spring grazing can be used to clean up swaths that were not accessible during the winter months, or specific areas or swaths can be left for spring grazing. When cow-calf pairs graze swaths after calving rather than perennial pastures, this provides a longer rest period for perennial pastures prior to spring turn out. Supplemental energy should be provided if nursing cows are swath grazing in the spring.

Swath grazing is a viable option for many cattle producers. The practice offers the potential to reduce feed, labour and manure handling costs. Producers need to carefully assess field characteristics, animal condition and options for crops, water sources, shelter, fencing, residue management and manure management. The viability of swath grazing depends largely on local conditions, snow depth and wildlife problems. Producers need to assess the economic feasibility for their own situation.

### GRAZING LEGUME PASTURES

Alfalfa is one of the few forages with the nutritional “oomph” on pasture to be able to sustain levels of production that are comparable to those achieved in the feedlot. The potential for increased stocking rates and enhanced beef production as a result of grazing alfalfa has been estimated to have an annual value of \$332 million to Alberta’s producers. Compared to grazing mixes of grass and legumes, grazing pure stands of alfalfa can more than double the net farm income generated. Under irrigation, beef production from grazing alfalfa can

be phenomenal. Production yields of 622 kg (1,371 lb.) of beef per acre of alfalfa have been reported. In spite of the fabulous potential of beef production from alfalfa, the problem of pasture bloat continues to limit the widespread adoption of alfalfa grazing systems. Numerous technologies to address bloat are currently available. These include bloat-reduced alfalfa (AC Grazeland, developed by Agriculture and Agri-Food Canada), the CRC Bolus (Elanco Animal Health), Bloat Guard (Pfizer Animal Health) and Alfasure® (Rafter 8 Products).

Forages are classified as bloat-causing, low-risk or bloat-safe (Table 57). The type of pasture forage usually determines the risk of bloat. Grasses are usually bloat-safe, but common legumes such as alfalfa and clovers may not be. Several less popular legumes have been pastured intensively without causing bloat. The bloat-causing potential of crops is related to the ease with which they are digested by rumen microbes. Bloat-causing forages are digested rapidly, while bloat-safe forages are digested more slowly. Alfalfa is the most commonly used legume for grazing, but it also has the highest risk of causing bloat.

## FACTORS AFFECTING BLOAT IN ANIMALS GRAZING ALFALFA

### The plant

Alfalfa has an initial rate of ruminal digestion that is five to 10 times greater than that of most grasses. The rapid microbial colonization and digestion of alfalfa reduces particle size and increases the passage of digesta from the rumen, enabling the animal to consume greater quantities of forage. Whereas this rapid digestion and

particle size reduction is responsible for the high productivity of cattle on alfalfa pasture, it also is in part responsible for bloat.

Although the scientific jury is still out, there is ample evidence to suggest that the soluble protein in alfalfa plays a major role in pasture bloat. For example, the reduction in soluble protein levels that occurs as alfalfa matures is closely associated with a reduction in bloat risk. Bloat risk is highest when alfalfa is in the vegetative to early bloom stages of growth. As alfalfa enters into the full bloom or post bloom stages, soluble protein levels decrease, plant cell walls thicken, lignin content increases and the rate of digestion of alfalfa in the rumen decreases. Consequently, many experienced producers do not allow their cattle to graze alfalfa until it is in full bloom. Soluble protein levels may also be higher in the plant early in the day. This may be why many researchers recommend that cattle be turned onto alfalfa pastures after the morning dew is off the alfalfa. Other strategies of bloat prevention such as wilting of alfalfa also lower soluble protein levels in the alfalfa.

Although one might think that the same effect would be achieved after a good fall frost, freezing can rupture plant cell walls and increase the release of soluble protein in the plant. Thus, the idea that alfalfa is bloat-safe after a frost is not true. It is likely that the risk of bloat in frozen alfalfa decreases with time, as proteins complex with carbohydrates in a manner similar to that achieved with wilting or drying. However, as many a dairy farmer can attest to, cattle can still bloat on alfalfa hay. Therefore, long-term frozen alfalfa should be considered bloat-reduced, not bloat-safe.

TABLE 57. Classification of bloat potential of forages used as pasture

Bloat-causing	Low-risk	Bloat-safe
Alfalfa	Arrowleaf clover	Sainfoin
Sweet clover	Spring wheat	Bird's-foot trefoil
Red clover	Oats	Cicer milkvetch
White clover	Canola	Crownvetch
Alsike clover	Perennial ryegrass	Lespedeza
Winter wheat	Berseem clover	Fall rye
	Persian clover	Most perennial grasses
	AC Grazeland alfalfa	

## The animal

Proper management of the animal is just as pivotal to bloat prevention as the management of the plant. Although there are few experiments to prove the concept, most experienced producers would agree that cattle must learn to graze alfalfa. Cattle that have not grazed alfalfa will invariably consume most of the other forages (e.g. grasses, dandelions) that are present in the pasture. This may result in a false sense of security as cattle will seldom bloat while these alternative forages remain in the stand. However, as these forages become depleted, the risk of bloat increases and this scenario is often responsible for bloat outbreaks two to three days after animals have been moved to a new pasture.

Uniform and regular intake is the key to managing animals on alfalfa pastures. Cattle should never be introduced to an alfalfa pasture when they are hungry. Providing cattle with a mixture of good quality alfalfa-grass hay can provide the rumen fill that is necessary to prevent over-consumption of fresh alfalfa when cattle are first introduced to the pasture. High stocking densities increase competition for the alfalfa, thus reducing the likelihood of any one animal selectively grazing only the top portion of the plant. Keep in mind that a high stocking density is not the same thing as overgrazing the alfalfa stand until it looks like it has been run over by a lawn mower.

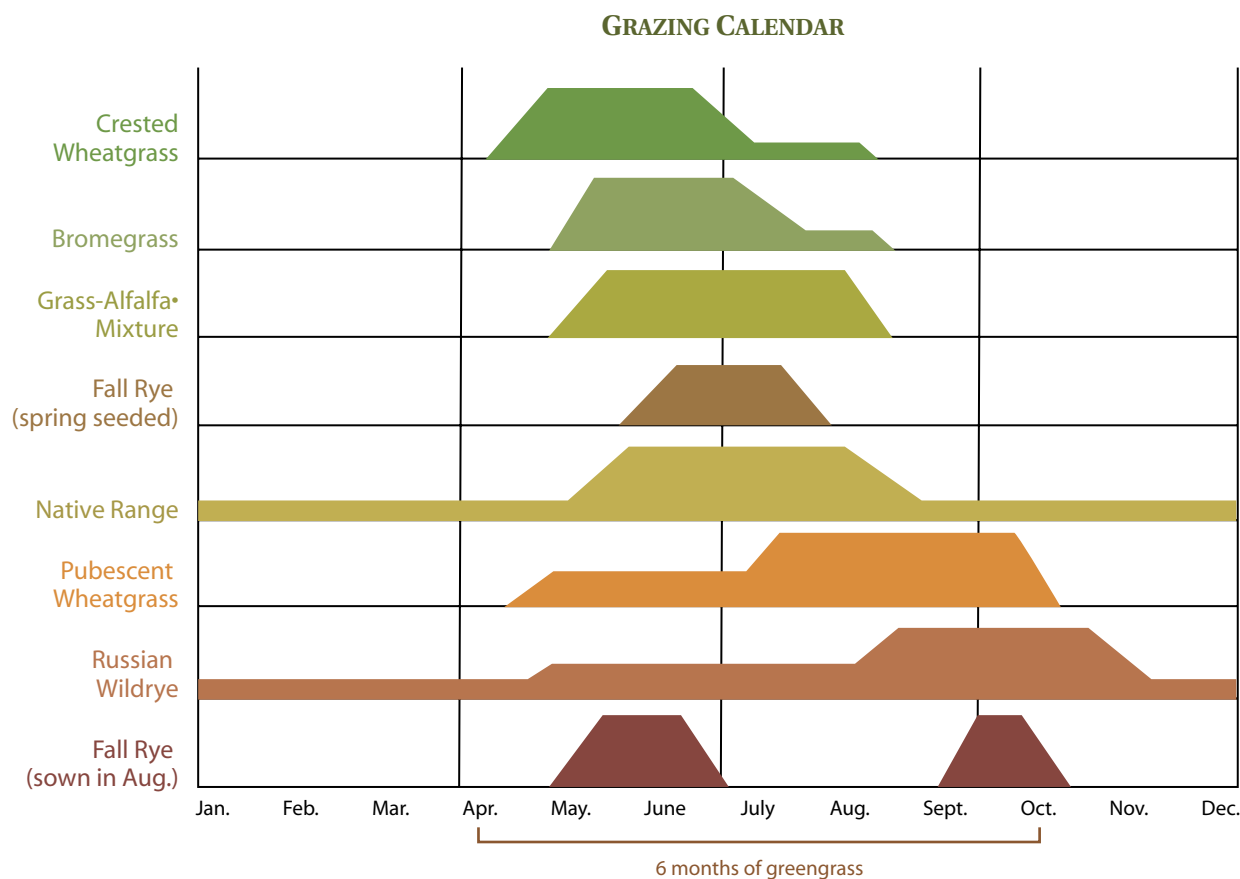
Once introduced, every effort should be made to maintain the herd on alfalfa pasture. Grazing pure legume pastures can improve animal performance (ADG/day) by 30 per cent or more. Animals often experience mild bloat when they are first introduced to alfalfa. This condition can often be treated by simply keeping the animal walking until the gas dissipates. Removing the animals from the pasture and reintroducing them at a later date often only increases the risk of bloat, unless the initial grazing attempt was made in the bud or pre-bud stage of growth. If rotational grazing is used, care should be taken to ensure that the initial paddock is not overgrazed to the point that animals are hungry when they are introduced into a fresh paddock. Cattle should be moved to the next paddock with 7.5 to 10 cm (3 to 4 in.) of forage still in the stand.

Management of cattle on alfalfa pasture is a dynamic art and must be done with an appreciation of the factors that can cause fluctuation in the intake of alfalfa. Environmental factors that interrupt regular grazing bouts on alfalfa pasture such as storms, exceptionally hot weather or biting flies can alter intake patterns and increase the risk of bloat. During these periods of high risk, animals should be observed for symptoms of bloat more often as these conditions often lead to multiple bloats or bloat storms. Cattle generally have three to four grazing bouts per day on alfalfa pastures. Major bouts tend to occur shortly after sunrise and early in the evening. Bloat usually occurs an hour to an hour and a half after a major grazing bout. Consequently, familiarity with the grazing patterns of the cattle can enable producers to adjust their management practices to observe the animals during times of greatest bloat risk. (For information on bloat treatment refer to the *Animal Health Management* chapter.)

## GRAZING MANAGEMENT TIPS TO REDUCE BLOAT

Follow these tips to reduce the risk of bloat and to improve the productivity of the pasture:

- Use non-bloating legumes such as cicer milkvetch, sainfoin and bird's-foot trefoil.
  - Be aware that these forages are not as good as alfalfa in terms of yield, regrowth and persistence in the stand.
- Manage grass/legume pastures as a straight legume pasture would be managed for grazing.
- Graze a low-risk bloat potential alfalfa such as AC Grazeland.
  - This variety results in a lower initial rate of digestion (LIRD), which helps prevent the onset of bloat.
- Graze legume-grass mixtures.
  - This improves animal and pasture productivity as well as managing bloat.
  - When legumes are planted with grasses, their presence can improve animal performance (ADG/day) by as much as 15 per cent.
- Graze alfalfa or clover pastures after plants begin to flower.



**Figure 50.** Typical patterns of pasture production through the grazing season

- Use products or supplements to manage bloat.
  - Examples include Alfasure® (non-ionic surfactant), Bloat Guard (poloxalene) and ionophores (e.g. CRC Bolus).
- At initial turnout, wait until pastures are dry and move the cattle into the pasture after the dew is gone (i.e. midday).
  - In a rotational grazing system, rotate cattle to a new pasture during the afternoon.
- Never move hungry cattle into legume pastures in the morning.
- Feed another source of dry roughage (long fibre) before grazing bloat-causing legumes.
- Maintain a uniform and regular intake of forages.
  - Once cattle have started grazing, leave them on the pasture, even at night.
- When animals are first put on pasture, check them at least twice a day.
  - Some animals are chronic bloaters. Watch for these animals and remove them from the pasture if necessary.

## Grazing Systems

A grazing system is a way of managing the interactions between plants, soils and grazing animals. If you graze cattle, you already have a grazing system of some kind. As you begin to design or redesign your grazing system, remember that any grazing management problem usually has many possible solutions and very few things you can do are right or wrong. Most of all, remember that no one grazing system is the best.

Traditional grazing systems, using perennial pastures of native or domesticated forage species, let the cow choose where, when and what she eats. When these systems are successful, the reduced costs of managing balance the lower productivity.



Many traditional systems are resilient and sustainable. A few have successfully weathered a century of economic and environmental change. Production levels follow the normal seasonal cycle of production (Figure 50).

Monoculture pastures need specialized management systems to maintain forage quality and intake rates throughout the grazing season. For mixed pastures, the producer needs to be keenly aware of what plants are being eaten and when many different decisions and observations need to be made during the grazing season.

Grazing management is the care and use of range and pasture to get the highest continuous yield of animal products without endangering the forage plants, soil, water resources and other important attributes of the land. This is accomplished by first maintaining adequate leaf area of desirable plants to intercept sunlight on which photosynthesis depends and then controlling grazing so that plant vigour is maintained and the water and nutrient cycles are enhanced.

The goals of good range and pasture management are to:

- keep the pasture covered with desirable and healthy forage plants
- maintain a range feed reserve
- increase livestock production capacity and wildlife habitat
- improve the land's water-holding capacity and prevent rapid runoff of rainfall
- control soil erosion

## GRAZING MANAGEMENT PRINCIPLES

### Class of cattle

Graze the class of cattle best matched with the kind of forage available and its nutritional quality. For example, dormant forage will not meet the high nutrient requirements of cows in late pregnancy.

Match the class of cattle to your area's topography. Cows with calves usually will not use steep topography as fully as dry cows or yearlings.



*Pasture management varies according to the type of pasture and the time of year.*

Use the type of cattle accustomed to your environment. Cattle raised on flat, open grasslands usually do not adapt well when relocated to timbered grazing lands or swampy land.

Consider the animal's previous grazing experience. Cattle unfamiliar with the kind of plants in a pasture usually will not perform as well as cattle that have previously grazed similar forages.

### Number of cattle

This is probably the most important decision for any grazing system. Too many animals on a pasture will not only cause cattle performance to decline, but the soil and vegetation will deteriorate before animal performance begins to suffer. Most grazing systems that include strategically timed ungrazed periods during the growing season will, over time, support more animals than grazing systems where pastures are grazed continuously throughout the growing season.

### Grazing distribution

When grazing animals are used to harvest a forage crop, they must be manipulated to graze as uniformly as possible. If left to their own devices, livestock will continually graze small areas, keeping them closely grazed, while leaving other areas relatively untouched. The tools available to achieve more uniform grazing include water supply locations, salt and mineral locations, fencing, cattle oilers or rubbing post locations, shelter locations and herding cattle to unused portions of range.



*Cattle access water by using a nose pump.*

The objective in developing water supplies is to provide a more even distribution of animals over the range and use areas that would not be grazed because of lack of water. Providing water close to grazing areas also improves the distribution of

manure and urine on the pasture, which benefits nutrient cycling and pasture fertility. Cattle should not have to travel more than 3 km (1.8 miles) in flat country and no more than 0.8 km (0.5 miles) in rough country to get water. Installing access ramps or pumps (solar, nose, etc.) to keep cattle out of the water source can preserve springs, seeps, ponds and dugouts. Development can include drilling wells, constructing reservoirs or installing surface or shallow buried pipelines.

Salt and mineral location can be used to improve grazing distribution because animals usually seek out salt. To improve distribution, salt and minerals should be placed away from the water, in areas where animals are not grazing. If the salt is moved periodically, the animals usually follow the salt.

Cattle oilers, rubbing posts and shelters can be placed strategically to improve cattle distribution in a field.

Fencing is used in rotational grazing systems to improve grazing distribution. The first requirement is to restrict cattle to the grazing land. The second is to force livestock into areas not usually frequented. Uniform grazing is one of the advantages of using a short-duration grazing

system with eight or more pastures. Short-duration grazing also provides a rest period for pasture, which is important in maintaining high yield and good condition. This rest break is especially critical for native pastures under a deferred rotational grazing system. Table 58 shows the effect of increasing paddock numbers on the percentage of paddock resting at any time.

### Carryover

Carryover is the amount of forage left when grazing ends. Green plants manufacture their own food. When they are grazed moderately, some of this food is used for further growth and some is stored in the roots. The food manufacturing process stops when all the leaves are removed. Plants then depend on root reserves to produce new growth and they die if reserves are depleted. Leaving adequate carryover assures there are adequate root reserves to maintain yield in the following year.

On native range, 45 per cent of the current growth and 20 per cent of the seed stalks should remain uneaten. A carryover of 45 per cent each year is impractical because production varies from year to year. This variation may range from 35 to 250 per cent of average production of forage. The 45 per cent carryover is an average value that the proper stocking rate will yield over a period of years.

The need for carryover on tame pastures is not as critical as for native range, but it does affect regrowth and moisture retention. A utilization of 70 to 75 per cent is considered proper use. This is usually estimated by average stubble height when the cattle are moved to a new pasture. Although proper use according to height varies with the pasture species, a rule of thumb is to remove the cattle when the average stubble height in the pasture reaches 7.5 to 100 cm (3 to 4 in.). Continual severe grazing causes depletion of food reserves, reducing stand vigour.

TABLE 58. An example of a deferred rotational grazing system

Pasture	First Year			Second Year		
	Spring	Summer	Fall	Spring	Summer	Fall
No. 1	Grazed	Ungrazed	Grazed	Deferred	Grazed	Grazed
No. 2	Grazed	Ungrazed	Grazed	Grazed	Ungrazed	Grazed
No. 3	Deferred	Grazed	Grazed	Grazed	Ungrazed	Grazed



*Fall grazing a native pasture allows the plants to rest during the critical growth period.*

### Grazing selectivity

Cattle select those plant species and plant parts they find the least objectionable. Grazing systems can affect the extent to which cattle are allowed to graze selectively. Maximum individual animal performance will result when cattle are allowed to be the most selective in choosing their forage. Individual animal performance drops below maximum whenever cattle are forced to graze less selectively.

### Timing of grazing

Avoid grazing too often during critical stages of plant growth, especially on native pastures. The most critical stages are when plants are initiating new growth. This includes new growth in the spring or fall, and midseason growth after grazing. New plant growth requires energy from the plant and the plant needs a chance to replenish the energy used. To produce energy, the plants need ungrazed leaf tissue because leaves are the main sites of energy production for the plant. If too little leaf area remains after grazing, the plant is unable to regrow and replenish its energy reserves. Also, you need to leave enough plant material to hold the soil in place. Avoid grazing an area at the same time of year, year after year as this will lower the pasture's production. Use a deferred grazing system that allows a native pasture to rest during the critical growth period, which will allow the plants to rest. This improves pasture health and productivity. (See to Table 58 for an example deferred rotational grazing pattern.)

### Frequency of grazing

Avoid grazing a pasture too often during a single growing season. If given an opportunity to regrow and replenish its energy stores, a plant can be grazed several times during one growing season.

If grazing is too infrequent, too much dead material chokes some plants and subsequent plant growth is restricted. Too infrequent grazing also causes the forage's nutritional quality to decline.

Cattle should not be moved from pasture to pasture simply by the calendar, but based on the growth rate of the pasture and the specific height of forage. In the spring, when forages are growing rapidly, rotate pastures quickly (every four days or less), grazing to a higher height of 15 to 20 cm (6 to 8 in.), but sufficiently to avoid heading and physiological maturity of the forage.

As summer progresses and the grass growth rate declines, decrease the frequency of rotation. Allow the cattle to graze the grass to as low as 10 cm (4 in.), thereby increasing the rest period between grazing periods. Slowing the rotation enables a feed reserve to be carried from periods of rapid growth to periods of slower growth. The final grazing should allow 5 to 7.5 cm (2 to 3 in.) of carryover for rapid growth the next spring.

### DETERMINING STOCKING RATES

Since forage production depends on soil and climatic conditions, as well as the condition of the pasture stand, calculating a stocking rate for each individual pasture on a farm is necessary. Applying average values to a specific situation could lead to a forage surplus or to overgrazing.

TABLE 59. Animal unit equivalents

Animal unit equivalents	Animal unit (AU)
Mature cow – with or without calf	1.0
Mature bull	1.3
Yearling steer or heifer	0.67
Weaned calf	0.5

The stocking rate is expressed as the number of animal unit months (AUM) supplied by 1 acre of pasture for one year. An animal unit (AU) is considered to be one mature 454 kg (1,000 lb.) cow with or without calf, or the equivalent (Table 59). It is based on an average daily forage consumption of 12 kg (26 lb.) of dry matter. Table 60 provides the stocking rates for seeded tame pastures in Alberta. It assumes average inputs and continuous grazing. If you are using a fertilizer program and rotational grazing, then use the stocking rates from the next higher precipitation zone.

TABLE 60. Stocking rates for seeded tame pastures in four pasture condition classes, AUM/acre in Alberta

Annual precipitation zones mm                      in		Stocking rates (AUM/acre)			
		Excellent pasture condition	Good pasture condition	Fair pasture condition	Poor pasture condition
250 - 350	10 - 14	0.75	0.50	0.40	0.25
350 - 450	14 - 18	1.25	0.80	0.60	0.40
450 - 550	18 - 22	2.00	1.40	1.10	0.70
550 - 650	22 - 26	3.30	2.20	1.60	1.10
Irrigation		7.50	5.00	3.75	2.50

Source: Wroe (1983)

### Pasture condition classes

The following pasture condition definitions only apply to pastures in the 250 to 550 mm precipitation zones, not to irrigated pastures.

#### Excellent

- 75 to 100 per cent of the top yield for the area
- 95 per cent of the production coming from adapted grasses and legumes\*
- 10 to 50 per cent of the production coming from an adapted legume
- less than five per cent of the total production coming from weeds or undesirables
- fertilizer program average to above average

#### Good

- 60 to 75 per cent of the top yield for the area
- 90 per cent of the production coming from adapted species\*
- less than five per cent legume in the stand
- less than 10 per cent of the production coming from weeds or undesirables
- fertilization program average

#### Fair

- 50 to 60 per cent of the top yield for the area
- 60 per cent of the production coming from adapted species\*
- 20 per cent or more of the total production coming from weeds or undesirables
- fertilization program below average or nonexistent

#### Poor

- 33 to 50 per cent of the top yield for the area
- less than 50 per cent of the production coming from adapted species\*
- should be cultivated and reseeded to adapted grasses and legumes
- fertilizer response questionable

\* “Adapted grasses and legumes” or “adapted species” are those species listed in *Varieties of Hay and Pastures for Alberta*, Agdex 120/32 from Alberta Agriculture and Food.



## Sample calculations for determining stocking rates

### Example: Calculating number of pasture acres required.

Assume:

- 450 to 550 mm annual precipitation zone
- Excellent pasture condition class
- 2.0 AUM/acre – carrying capacity
- Grazing season 165 days (5.5 months)
- 80 cow-calf pairs (80 AU)

$$\begin{aligned} \text{Required pasture (acres)} &= \frac{(\text{AU} \times \text{months of grazing})}{\text{AUM/acre}} \\ &= \frac{(80 \times 5.5)}{2.0} \\ &= 220 \text{ acres for the grazing season} \end{aligned}$$

Note: If using superior management and rotational grazing, the pasture required could be as low as 135 acres.

### Example: Calculating pasture capacity.

Assume:

- 450 to 550 mm annual precipitation zone
- 200-acre grass-legume pasture (excellent condition – 2.0 AUM/acre)
- want 120 days grazing (4 months)

$$\begin{aligned} \text{Pasture capacity (AU)} &= \frac{(\text{acres} \times \text{AUM/acre})}{\text{months of grazing}} \\ &= \frac{200 \times 2.0}{4} \\ &= 100 \text{ AU} \end{aligned}$$

100 AU equivalents are 100 cow-calf pairs or 133 yearlings.

## The modern cow and calf – adjusting for size

A generation ago, most cows in Alberta were of the traditional British breeds. They weighed 340 to 430 kg (750 to 950 lb.) and weaned a 138-kg (305-lb.) calf. Crossbreeding programs with mostly continental European breeds have increased cow size to an average of 544 to 590 kg (1,200 to 1,300 lb.). The range in cow weights extends from 454 to 680 kg (1,000 to 1,600 lb.). These larger cows require more energy for maintenance and for greater milk production. The genetic changes that boost cow size also yield a larger-framed calf. This calf size, combined with a general shift towards earlier calving, clearly suggests the modern calf requires more nutrition than the standard calf. The bottom line is that bigger cows and heavier calves eat more grass, so adjustments need to be made when matching livestock needs with available forage.

Critical factors to consider are cow size (live weight), milk production level and calf size. In Table 61, the energy requirements of the 454 kg (1,000 lb.) AU with standard milking ability and an average calf are compared with those of a large 680 kg (1,500 lb.) cow and her calf. The comparison is somewhat extreme, but it illustrates the effect that genetics can have on feed requirements. A 567 kg (1,250 lb.) cow will require 34 per cent more energy. If the cow weighs 680 kg (1,500 lb.) and also is a heavy milker with a large-framed calf weighing 227 kg (500 lb.), her energy needs rise to 64 per cent more than the standard cow. The forage required is more or less proportional to the increase in live weight, particularly when you consider that, generally, larger cows are heavier milkers and raise larger than average calves.

If producers stock their pastures with the same numbers of these larger animals as they once did with standard-sized animals, and if they do not reduce the grazing period appropriately, overgrazing will result. The total livestock demand for forage will exceed the capability of the land to supply forage and the grazed pasture will suffer. A practical solution is to adjust for changes in cow size on an animal unit equivalent basis by adding 0.1 AU for every 45-kg (100-lb.) increase in live weight above the standard AU. For example, a 567-kg (1,250-lb.) lactating cow would constitute 1.25 AU.

Figure 51 shows how this adjustment for cow size would be put into practice for 450, 567 and 680 kg (1,000, 1,250 and 1,500 lb.) lactating cows with calves. The pasture with a carrying capacity of 100 AUM would provide one month of grazing for 100, 80 and 67 head, in the preceding weight classes. The number of cows that can graze a field with a carrying capacity of 100 AUM for one month declines as cow size increases. This simple adjustment can also be applied to other classes of stock.

TABLE 61. Effect of cow size, milk production and calf size on energy requirements

Cow Class	Energy/forage requirements		
	Mcal/day	Energy/forage requirements (%)	Animal unit
454-kg (1,000 lb.), standard milker at 4.5 kg (10 lb.) milk/day and average calf	25	100	1.00
567-kg (1,250 lb.), standard milker at 8.6 kg (19 lb.) milk/day and average calf	34	134	1.34
680-kg (1,500 lb.), heavy milker at 11 kg (25 lb.) milk/day and larger calf	41	164	1.64

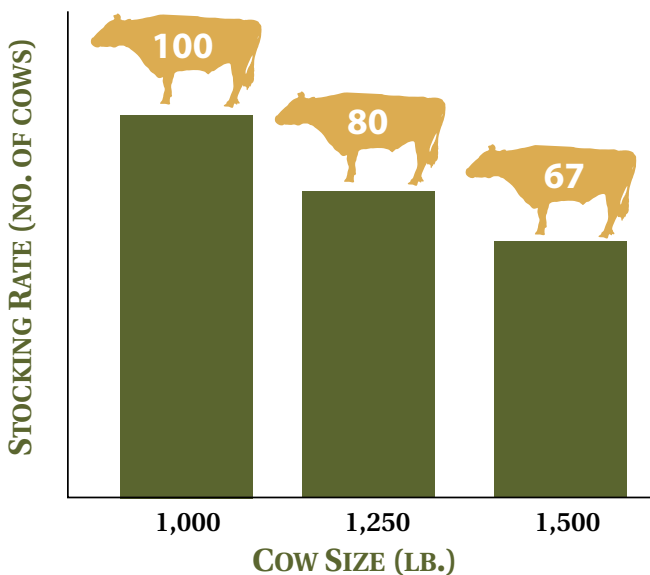


Figure 51. Stocking rate and cow size

## GRAZING MANAGEMENT AND POISONOUS PLANTS

There are several poisonous plants in various regions of Alberta. Find out the ones in your vicinity and learn to identify them. Only a few of these poisonous plants cause death: arrow grasses, water hemlock, tall larkspur and death camas.

Abnormal circumstances predispose cattle to poisoning. Overgrazing finds livestock going after species they may not normally eat. This is often how water hemlock is pulled out of low areas. Grazing too early, before the tame species start to come, allows grazing on early growing plants such as death camas. Producers should also be careful when hungry livestock are moved to a new area, as the animals will graze upon the first palatable plants they come to. Unfortunately, these may be poisonous.

Be especially vigilant in a drought year, when cattle graze whatever they can get a hold of. This is often when less palatable plants are consumed in abundance.

## Arrow grasses

Seaside arrow grass, *Triglochin maritima* and marsh or small arrow grass, *Triglochin palustris*, are herbaceous, perennial, grass-like plants. They are 15 to 76 cm (6 to 30 in.) tall. They are usually found in damp soils, marshes and sloughs, where the soil is alkaline or the water is brackish and usually where native vegetation has not been cultivated. These plants are found throughout Western Canada, but are not present in large numbers.

Arrow grasses start growing earlier in the spring than true grasses and grow quicker than true grasses after being cut. Arrow grasses are most dangerous at these times because of their availability. Livestock eat these plants readily at all times because of their salt content. Their poison, hydrocyanic acid, increases in plants that have been stunted by frost or drought and in regrowth after harvest. Hydrocyanic acid breaks down to cyanide and inhibits oxygen metabolism when it is ingested.

Symptoms of poisoning include slobbering, excitement, rapid breathing, staggering, muscle spasms and convulsions. Death occurs from asphyxia. With time hay containing arrow grass gradually loses its toxicity.

## Water hemlock, spotted water hemlock (cowbane or spotted cowbane)

This is considered the most poisonous plant in North America. Water hemlock is a member of the Umbelliferaer family (carrot family). It may grow to 7 ft. from its cluster of two to eight fleshy roots (Figure 52). Stems are smooth, branching, swollen at the base, purple-striped or mottled, and hollow except for partitions at the junction of the root and stem. It has leaves with serrated edges and veins proceeding to the edge of the leaf (Figure 52). It is found in wet places around marshy sloughs and stream banks. Stands of water hemlock tend to persist from year to year in the same spot. It is not



Figure 52. Water hemlock

uncommon to find one lone plant. Water hemlock is often confused with water parsnip, which has fair forage value and is much more common.

Water hemlock's thickened root system stores the food reserves for the plant and is the most useful feature in distinguishing the plant. A pungent oil in the root system changes from yellow to red within a few minutes of exposure to the air. The bundle of roots resembles those of dahlias, with hollow internodes and diaphragms of pith tissue across the cavities. One root bulb has enough toxin to kill a cow. Cattle are most likely to pull these out and consume them during drought conditions.

The highest concentration of the toxin, cicutoxin, is in the roots and rootstocks, but it also occurs in lower concentrations in the foliage. Symptoms of poisoning develop within 15 minutes of ingesting water hemlock. They include slobbering, violent convulsions, muscle tremors, painful abdominal spasms and diarrhea (if a cow survives the acute phase). Death is from asphyxia. The cattle are usually found dead right by the source (low area or dugout) as death is so rapid.

The above-ground parts of water hemlock decrease in toxicity over the growing season and lose additional toxin with drying. Hay containing water hemlock may not cause clinical toxicosis, but it is still advisable not to feed hay that contains water hemlock. The root may be still attached to the stem in the hay. The root is never safe, and remains toxic when dry and should never be fed.

Producers should be extremely careful around water hemlock root as two drops of the oil on an open cut can kill a human.



**Figure 53.** Tall larkspur

### Tall larkspur

Tall larkspur is a member of the buttercup family. This perennial forb stands between 1 and 2 m (3 and 6 ft.) tall. The leaves are deeply cleft (Figure 53). It is common in the foothills and at higher elevations in southern Alberta.

These plants are most toxic early in their growth and are the greatest threat in the early spring. Toxicity declines as they mature and they are relatively safe to graze in the late pod stage. However, late summer storms may increase the plant's metabolism and increase the toxic alkaloid concentration. The dried, mature plants are much less toxic. Although the seeds from mature plants are toxic, they are seldom eaten.

Symptoms of poisoning involve the nervous system and include weakness, muscle twitching and convulsions. Animals will fall down repeatedly. Recovery or death is rapid, usually within hours. There is no reliable treatment for this type of poisoning.

The only preventive measure is to cut larkspur early in the season. Producers often go in and cut out patches of tall larkspur, as it is difficult to control with spraying. Sheep are four to six



**Figure 54.** Death camas

times more resistant to this poison than cattle. If sheep are available, they are often put out to graze pastures with tall larkspur early in the season.

### Death camas

This plant is a member of the lily family and is common in Saskatchewan and Alberta. It has many creamy yellow flowers and grows from a bulb similar to an onion (Figure 54). It is scattered over the grazing area in depressions and draws.

All parts of the plant are poisonous, especially the bulbs. This plant reaches a grazing height early in the year, so it is most dangerous in the early spring. It is also poisonous in the dried state and in hay.

Poisoning is rapid, with severe congestion and bleeding in the lungs. Death occurs from cardiac arrest. Cattle may remain in a coma for several hours before dieing.

To avoid poisoning, delay spring turn out until adequate grass is available. Death camas is one of the first plants to green up in the spring. Death camas can be controlled with 2,4-D if sprayed during early growth. It is most important to keep stock away from this plant.



## Pasture Water Quality

In the past, livestock were turned out to pasture and allowed to walk through and drink from any slough, creek, river or lake available to them. When these water sources were not available, dugouts were constructed.

Today, allowing livestock direct access to surface water sources is a concern to livestock producers and to other water users. The practice is also problematic for the livestock.

Livestock producers want to provide a safe, reliable supply of good quality water for their livestock. Many producers want to increase their management to better utilize their pastures for livestock production. Livestock producers, like other water users, want to do their part to protect both natural and constructed water sources from environmental damage.

Allowing livestock direct access to surface water sources can lead to a number of environmental, herd health and pasture utilization problems.

Environmental problems:

- damage to banks of streams and dugouts
- siltation problems in spawning areas for fish
- loss of riparian habitat and vegetation
- loss of water storage in dugouts and streams
- nutrient buildup in both the source and downstream water bodies

*Limiting access to dugouts improves water quality.*



- rapid growth of weeds and algae
- deterioration in water quality

Herd health problems:

- increased exposure to water-borne diseases
- blue-green algae toxins
- footrot
- leg injuries
- stress
- death by drowning or being stuck in mud
- reduced rates of gain

Poor pasture utilization:

- poor nutrient transfer caused by an accumulation of manure at the water source
- overgrazing near the water source

## PASTURE WATER SYSTEM TRIALS

Both poor access to water and poor water quality can affect livestock behaviour and production on pasture. In a pasture trial, however, it is extremely difficult to isolate what, how and when these factors become significant. There are so many variables in the cattle, pasture grass, water source and water quality.

Some pasture studies have shown a significant increase in cattle production where water was pumped cattle rather than providing direct watering from dugouts. Other studies have shown little or no improvement in livestock production. The studies have all shown that, although cattle prefer that good quality water be pumped to them versus direct watering from a dugout, their behaviour is not consistent.

For instance, some studies have shown that cattle, given a choice between clean well water and dirty dugout water, will drink more clean well water one day and do the opposite the next day. This complexity aside, the combined benefits of pasture water systems strongly support keeping cattle out of water.

## PASTURE WATER SYSTEMS BENEFITS

The benefits of a well planned and constructed pasture water system include:

- water source protection, thus longer water source life
- improved herd health
- increased livestock production, in some situations
- better pasture utilization
- riparian protection and a more environmentally friendly livestock industry

Where livestock are allowed direct access for watering, the loss in dugout water storage and additional maintenance costs range from \$200 to \$500 per year for an average pasture dugout.

## PASTURE WATER SYSTEM OPTIONS

Today, a variety of livestock watering methods are available to suit any type of pasture and location. The power options to move water to livestock include solar, wind, fuel, stream flow, mainline electricity and gravity flow. Selecting the most appropriate one can be a challenge.

Establish a list of priorities and try to use some of the natural advantages of the site and equipment. Factors to consider include:

- type and location of available water source(s)
- site location(s) and conditions (e.g. remote location, topography, riparian features)
- type of grazing system (intensive or extensive)
- number of livestock
- access to power source (mainline power, solar, wind, animals, etc.)
- pumping system (amount of lift, automated versus manual)
- flexibility and portability
- reliability and maintenance
- temporary or seasonal water storage
- cost/benefit and cost/animal
- personal preference

Stock water samples can be analyzed to determine the water quality. A chemical analysis determines pH, total salt content (total dissolved solids) and minerals. A bacterial analysis indicates if water contains micro-organisms, such as bacteria. Water samples can be submitted to private laboratories for analysis for livestock consumption. Total dissolved solids (TDS) and salinity are important considerations. The TDS level should be under 3,500 ppm for cattle consumption. Water approaching 1.25 per cent salt is toxic to livestock.

In order to maintain healthy dugouts, it is important to have up to a two-year supply of water. Aeration, through the use of windmills, helps eliminate algal growth. Eliminating direct access to the water source helps stop unwanted contaminants from building up. Dugouts can be fenced off and the water can be pumped into troughs using wind or solar power. Given the choice between an unfenced dugout and a better source of water, cattle will usually select the better source.

Animal-operated pasture pumps are commonly called nose pumps because cattle operate them by pushing them with their noses. A single nose pump has the capacity to supply water for 30 to 40 cow-calf pairs. However, calves need to weigh at least 300 pounds to operate them. It takes a few days for cattle to master the use of nose pumps.

There are five or six types of nose pumps being sold in Alberta, including one frost-free pump that is suitable for winter use. Some of the pumps are slightly easier to push than others. They all supply approximately 1 L of water for every stroke of the nose device. The pumps can lift water a maximum of 20 vertical feet. With the use of a shallow buried pipeline they can also be offset 0.4 km (a quarter of a mile) or more from the water source. Minimizing the amount of elevation lift from the water source makes it easier for cows and calves to operate the pump. Shallow burial of the pipeline is recommended once the best locations for the pumps have been determined.

Shallow lines can also be dug in to allow wells to supply pastures in different locations. These lines need to be blown out in the winter to prevent freezing.

Water is the nutrient of life. Animals will only survive seven days without it. It pays to check water quality and to ensure that disease is not introduced through this source.

### **BLUE-GREEN ALGAE POISONING**

The accumulation of algae on water is called an algal bloom. It consists of one or two of several types of algae that can cause poisoning. Its toxicity can change fairly quickly. The formation of a toxic bloom depends on several factors. A steady, gentle wind, warm water temperatures, the presence of large quantities of nutrients in the water (such as phosphorus from feedlot runoff or fertilizers) and a lack of water flow all contribute to the development of a toxic bloom.

Several toxic compounds may be produced. The degree of toxicity is related to the amount of toxins consumed by cattle, as well as the species of algae involved. Death occurs within one to 48 hours after ingestion. The signs of acute poisoning are tremors, staggering, convulsions, abdominal pain, diarrhea, difficult breathing and death. A chronic form of the disease is reported to cause liver damage, resulting in jaundice and photosensitization (the peeling of light-coloured skin from sun exposure).

Treatment of affected animals is usually of little value. Adding copper sulphate to dugout water (0.25 to 0.50 kg (0.55 to 1.1 lb.) of copper sulphate to 100,000 gallons of water) will kill algae. Little can be done to control algae growing in larger bodies of water such as sloughs.

Although ideal conditions for this type of poisoning are short lived, large losses can occur at one time. Water sampling may prove ineffective because the poison dissipates very quickly and samples may show negative results. Preventing cattle access to sloughs may be the only practical preventive measure available. Measures to prevent manure and other nutrient sources from entering the water body may help to reduce the risk of algal blooms. These measures include developing off-site watering systems, redirecting feedlot runoff and maintaining vegetative buffer strips around the water body.

## **Summary**

Your feeding program needs to provide adequate nutrition to the cow, calf and bull at all stages of growth, in all seasons and at a reasonable cost. Inadequate nutrition at any time of the year results in lowered reproductive performance in the herd, either immediately or at a later date.

Adequate nutrition means providing the animal with specific levels of the nutrients required for maintenance, growth, production and reproduction, and avoiding deficiencies and excesses. These nutrients include energy, protein, minerals, vitamins and water.

Energy is usually the most expensive and most limiting nutrient in a ration. Energy is required for maintenance, growth, work, reproduction and milk production. One common way of expressing the energy value of feeds is the net energy system where energy is separated into net energy for maintenance ( $NE_m$ ) and net energy for gain ( $NE_g$ ) or net energy for lactation ( $NE_l$ ).

Proteins play an important and varied role in animal metabolism. The vast majority of protein consumed by the animal is digested by the microbes in the rumen to produce amino acids. The protein in the bodies of the microbes is then digested and used by the animal for maintenance and production.

The most important major minerals for cattle are calcium, phosphorus, sodium, potassium and magnesium. Copper, zinc iodine and selenium are the minor or trace minerals that are most often deficient in feeds grown in Alberta. Vitamin A should be added to all cattle diets. Water should be available on a free-choice basis at all times.

Water is an important nutrient for beef cattle. Water intake varies depending on the age of the animal, rate and composition of gain, lactation, activity, type of diet, feed intake and air temperature. Producers need to monitor their animals closely to determine if their water needs are being met. Snow alone can be used as a water source for pregnant cows, but lactating cows and their calves need to have access to a fluid water

source. It is essential that alternative methods of watering cattle are available if snow conditions or lack of snow becomes a problem.

Ensure that you provide the correct amounts and proportions of energy, protein, minerals and vitamins in your cattle diets. If possible, add mineral supplements and salt to the ration rather than feeding minerals free choice. Adding excess nutrients may cause unnecessary expenditures, decreased availability of other nutrients, or soil or water pollution (e.g. excess nitrogen, phosphorus or sodium) or other environmental concerns with runoff from cattle manure.

Nutrient requirements for cattle depend on whether you are feeding for maintenance, maintenance plus production or maintenance plus reproduction. First, nutrients will go toward meeting the animal's maintenance requirements, so it can maintain its weight and maintain basic physiological functions such as breathing, heart rate, eating, keeping warm and tissue repair. If more feed and nutrients are added to the diet, the animal will meet the production expectation of growth. Finally, if yet more feed and nutrients enter the body, the animal will be able to reproduce.

Estimates of dry matter intake expressed as a percentage of body weight are an excellent tool to monitor cattle in terms of ongoing progress, as a performance predictor and/or troubleshooting tool. Intake of high-roughage rations is limited by physical means; when the rumen is full, the animal simply cannot fit anymore feed in it. Feed intake on a high-energy ration is limited by total energy intake; the animal's brain says not to consume any more energy.

Rations are formulated based on the class of cattle. The levels of various nutrients in on-farm feeds can vary significantly, so it's important to have feeds analyzed and to use that information to decide on how to supplement the rations to meet the requirements of the various classes of cattle. The condition of cattle going into the winter has a major effect on the quality and quantity of feed they need over the winter.

Backgrounding rations are based on such factors as the type and weight of cattle purchased, delivery date, target weight and the negotiated conditions of sale. Finishing feeding programs target specific carcass quality characteristics of the finished animal. Feed additives and growth promotants can improve the health and productivity of beef cattle.

Feed analysis and computer ration balancing programs allow you to fine tune the feeding needs of your herd, but they do not replace the need to actively manage the feeding program. You need to be constantly aware of changes in weather, feed quality, feed wastage and feed intake. Body condition and weight change must be monitored to ensure that the feeding program is achieving the desired results. Use a condition scoring system and a livestock scale to accurately measure these factors.

The nutrition of the cow and calf during the grazing period is very important. Good pasture management practices are needed to meet the nutrient needs of cattle, while maintaining healthy, productive pastures and keeping production costs in line.

Pasture management requires producers to integrate forage management and grazing management with livestock nutrient needs. Forage management considerations include seeding and establishment, fertilizer management and weed control. Having both perennial and annual pastures can create a flexible pasture system. Grazing legume pastures can increase the amount of beef produced per area of grazing. Swath grazing can be used to extend the grazing season.

Grazing management includes consideration of cattle numbers and types and grazing distribution, timing, frequency and selectivity. Determining proper stocking rates is especially important. Stocking rates depend on such factors as precipitation levels, grazing system (e.g. continuous or rotational), fertilizer program, pasture condition and animal size.




 Animal

# Health Management

One way to increase production and lower production costs is through a preventive herd health program that focuses on the disease and management problems that cause economic losses. Economic losses in a cow-calf enterprise result from three major causes: clinical disease, subclinical disease (clinical signs are not observed) and variations in management that result in failure to achieve optimum production (pounds of calf weaned per cow).

Disease prevention and proper management are the keys to a successful herd health program. This chapter aims to make producers more aware of the various conditions that can affect their cattle, and consequently limit production. It will describe the causes, symptoms, prevention and treatment of the diseases that have the most economic impact on cow-calf production. It also discusses administration of drugs, caring for sick animals, diseases that are transmissible to humans and biosecurity.

Specifics about drug treatment are not included in this chapter because doses vary according to the location, size and type of animal, and the product being used. Changing trade names and drug strengths can also make dose information obsolete. You can obtain specific information on drug treatment from your local veterinarian.

Developing a good working relationship with your veterinarian is important. Involving your vet at the preventive level is more cost-effective than waiting until a disease has become advanced before consulting him or her. Too often a veterinarian is only called after all else has failed. The chance of saving an animal under these conditions is usually minimal and if the veterinarian is unsuccessful, the visit is frustrating for both the producer and the veterinarian.

Beef cattle, compared with other species of livestock, have a lower incidence of clinical disease overall. A veterinarian's most beneficial role in a herd health program is to ensure that preventive and control measures are followed and that the measures are in place to minimize potentially large losses from disease outbreaks or reproductive failure. Increasing the efficiency of production makes the greatest economic gain in most herds. A veterinarian, through a herd health program, can make a significant economic contribution here.

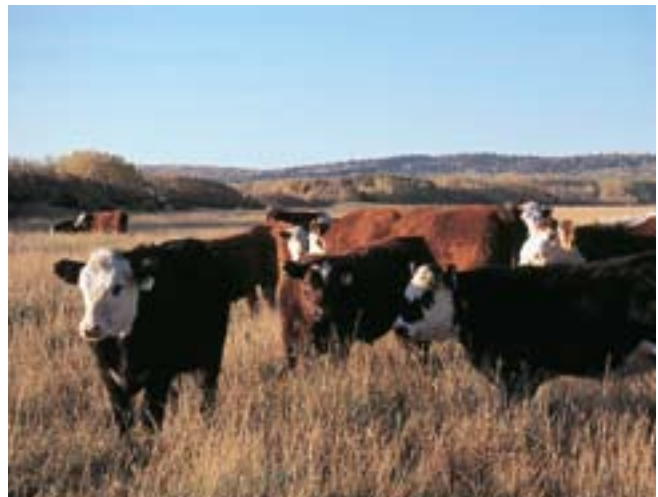
# Herd Health and Management Calendar

## Fall, Pre-weaning and Weaning

- Test for pregnancy.
- Cull all open and late-bred females and market them in a timely fashion.
- Remove any other poor-risk females (bad feet, bad udders, temperament, cesarean sections and vaginal prolapses).
- Do pregnancy checking and culling early to save money on feed. Feed costs tend to be higher in late summer and early fall.
- Give an initial scours shot to new cows and replacement heifers, six weeks before calving.
- Control internal and external insects and parasites (e.g. warbles). Treat cattle with pour-on or injectable insecticides or endectocides (chemicals that control insect pests and other parasites), preferably given before November 30.
- Prevent reproductive diseases that can cause open cows, abortion and persistently infected calves.
  - Give vaccinations (killed) for reproductive diseases such as infectious bovine rhinotracheitis (IBR) and bovine virus diarrhea (BVD).
- Vaccinate the cows and bred heifers to increase their immunity levels. This helps the dam protect her calf against calf scours.
  - Consider giving initial vaccinations for calf scours in the fall.
- Analyze feed ingredients for the winter feeding program and check the nutrient balance of winter feed rations.
- Wean calves and boost immunity levels by vaccinating for IBR, parainfluenza-3 virus (PI-3), BVD, bovine respiratory syncytial virus (BRSV), 8-way blackleg, histophilosis or as your veterinarian deems necessary.
- Implant non-replacement calves.
- Wean calves with a minimum of stress.
  - Pre-immunize calves before weaning to reduce stress and improve immunity with IBR, parainfluenza-3 virus (PI-3), BVD, bovine respiratory syncytial virus (BRSV), 8-way blackleg, histophilosis or vaccinate following your veterinarian's protocol or program.
  - Watch the calves for pneumonia and treat any problems promptly.
  - Weigh the calves and record their weaning weights.
- Make your initial selection of replacement heifers.
- Evaluate performance of the breeding herd by calculating:
  - per cent of calf crop
  - pounds of calf weaned per cow
  - death loss percentage
  - cost per pound of calf marketed

Several computer software packages are available to help producers with these calculations.

*Good pasture reduces stress at weaning time.*



## Wintering Period

- Work out rations for the different classes of cattle: pregnant heifers, pregnant cows, heifer replacements, bull replacements, breeding bulls and feeder calves.
- Two to three weeks before calving, give the booster vaccination for calf scours, especially to replacement heifers to increase immunity levels.
- Check the cows each day for signs of heat and rubbing or scratching due to external parasites.
- Watch for abortions. Submit aborted fetuses, with part of the placenta including the cotyledons (buttons on the placenta), to a veterinarian for diagnosis. Having the placenta with the cotyledons attached greatly increases the diagnosis rate.
- Reassess and maintain the nutritional health of cows and heifers by feeding a balanced ration with adequate energy, protein, minerals and vitamins. This is especially critical in the third trimester. Cows in good body condition (BCS 2.5 to 3) have fewer calving problems.
- Increase your knowledge about the beef business through:
  - research and extension publications (available from Alberta Agriculture and Food or veterinary clinics)
  - extension meetings
  - farm press, agricultural newsletters and the Internet
  - commercial firms and consultants
  - nutrition and management programs

## Pre-calving and Calving Season (Late Winter to Early Spring)

- Put the cows on a pre-calving mineral (at least 45 days before calving), as recommended by a

feed nutritionist or veterinarian.

- Watch for abortions and submit aborted fetuses to a veterinarian for diagnosis. The average abortion rate on Alberta farms is two to three per cent.
- Check cattle for lice and internal worms, and treat if infested.
- Discuss vaccinating the cow herd for calf scours with a veterinarian. Ideally, booster shots for scours are given two weeks before the first cow calves. This is particularly necessary if herd size gets larger than 200 head.
- Prepare for calving and calving problems. Have the necessary supplies (lubricant, sleeves, disinfectant, etc.) on hand.
- Obtain a supply of electrolyte solution and antibiotic preparations to treat scours.
- Have a good supply of frozen colostrum (the first milk from a cow after the calf is born) on hand.
- Keep the calving areas clean, dry and well bedded.
- Record calf birth dates and birth weights.
- Identify calves with your herd identification tag and apply the CCIA national cattle ID tags.
  - keep accurate birth date records for calves and enter the data into the CCIA Age Verification Program, which associates the animal birth date information with the CCIA animal identification number (single tag or tag group)
- Inject calves with vitamins A, D and E and selenium to help build immunity levels and reduce the incidence of white muscle disease.
- Watch for calf scours and pneumonia.
- Reassess the nutrient requirements and performance of heifers and cows and make the necessary changes.

## Breeding Season (Early Spring to Early Summer)

- Check daily for scours and pneumonia in calves.
- Evaluate the fertility of all breeding bulls by checking:
  - scrotal size
  - semen quality
  - physical condition
- Select the new bulls for the herd. Remember that the bull supplies half the genetic potential of your herd and the quickest genetic improvement can be made with the purchase of a quality purebred bull.
- Before turning cows out for breeding, have the vet examine all breeding females that suffered reproductive problems during or after calving.
- Assess the bull to female breeding ratio requirements. This ratio should be approximately 25:1.
- Prepare teaser animals if artificial insemination (AI) is to be used.
- Vaccinate all replacement heifers for IBR, BVD and 8-way blackleg no less than two weeks before breeding.
- Have replacement heifers palpated for reproductive soundness and pelvic size. This includes picking out freemartins (sterile female calves that are twinborn with male calves), as well as heifers with underdeveloped, infected and poorly sized and shaped reproductive tracts.
- Vaccinate cows and herd bulls for reproductive diseases at least two weeks before breeding, if they were not vaccinated in the fall. Live vaccines can be used if this is done before breeding.
- Vaccinate for blackleg all the calves that are between one and three months of age.

- Castrate, dehorn and implant calves.
- For fly and mosquito control, consider oilers, insecticide ear tags or pour-on products. If you are using tags, remember to change to different insecticides to prevent resistance from developing.

## Beef Cattle Diseases

The prevention and control of disease with minimal loss to death is an important aspect of the management of beef cow herds (Table 62). In the following discussion of diseases, a specific agent or factor is often given as the cause of the disease. However, other factors may contribute to the presence of the disease. For instance, the immune status of the animal, the concentration of the causative agent or crowding may irritate any disease. Environmental, nutritional, genetic or other factors, or a combination of these factors may aggravate the effect of the agent. Clinical signs of disease are usually the result of the interaction of many factors.

### Recognizing Clinical Signs of Disease

Every disease has its own specific clinical signs, but it is most important to recognize healthy, contented cattle. This makes the sick ones rather easy to detect. Healthy livestock come quickly for feed, their eyes will appear bright and alert and rumination (chewing their cud) is apparent. Rumination starts after several months in young calves, when their rumens develop. Until that time, they act very similar to a single-stomached animal.

Always watch for weight loss or poor weight gains, poor hair coats or other subtle signs of disease. Remember that many production loss diseases come on subtly. Diseases that reduce weight gains and reproduction capabilities rob you of your profit. Nutritional diseases also develop over time and reduce your profits.



TABLE 62. Summary of vaccination procedures for the control of some infectious diseases in Western Canadian beef herds\*

Disease	Time to vaccinate	Remarks
<ul style="list-style-type: none"> <li>Infectious bovine rhinotracheitis (IBR)</li> </ul>	<ul style="list-style-type: none"> <li>Replacement heifers and breeding herd, including herd bulls: at least 2 weeks prior to breeding.</li> <li>Calves: at weaning time or using a pre-immunization program 3 weeks prior to weaning.</li> <li>Weaned calves arriving in feedlots: within 24 hours of arrival.</li> </ul>	<ul style="list-style-type: none"> <li>Intranasal and killed vaccines are safe in pregnant cows.</li> <li>Two doses of killed product must be given to provide good immunity.</li> <li>Intramuscular vaccination may cause abortions in cows and bred heifers.</li> <li>If calves are vaccinated at 2 to 4 months of age, they should receive a booster shot when they are 6 to 7 months of age.</li> </ul>
<ul style="list-style-type: none"> <li>Parainfluenza-3 virus (PI-3)</li> <li>Bovine respiratory syncytial virus (BRSV)</li> </ul>	<ul style="list-style-type: none"> <li>Calves: at weaning time or using a pre-immunization program 3 weeks prior to weaning and again at weaning if killed vaccines are used.</li> <li>Weaned calves arriving in feedlots: within 24 hours of arrival.</li> </ul>	<ul style="list-style-type: none"> <li>Killed vaccines require two doses to stimulate protective immunity.</li> <li>Modified-live vaccines are also available. Follow directions carefully for these products to be beneficial.</li> </ul>
<ul style="list-style-type: none"> <li>Clostridial diseases                             <ul style="list-style-type: none"> <li>Blackleg (<i>Clostridium (C.) chauvoei</i>)</li> <li>Malignant edema (<i>C. septicum</i>)</li> </ul> </li> <li>Other clostridial diseases and malignant edema species                             <ul style="list-style-type: none"> <li>Infectious hepatitis (<i>C. novyi type B</i>)</li> <li>Bacillary hemoglobinuria caused by <i>C. novyi type D</i> (red water disease)</li> <li>Enterotoxemia caused by <i>C. perfringens</i> types B and C</li> <li><i>C. tetani</i></li> </ul> </li> </ul>	<ul style="list-style-type: none"> <li>Sucking calves: between 1 and 3 months of age.</li> <li>Weaned calves: second vaccination at 6 to 7 months or weaning time or using a pre-immunization program 3 weeks prior to weaning and again at weaning if killed vaccines are used.</li> <li>Weaned calves arriving in feedlots: within 24 hours of arrival.</li> <li>Replacements heifers and replacement bulls: at least 2 weeks before breeding season begins.</li> <li>All breeding cattle: revaccinated annually until 3 years of age if an outbreak has occurred.</li> </ul>	<ul style="list-style-type: none"> <li>A wide variety of vaccines are available in combinations that consist of bacterins, toxoids, or mixtures of bacterins and toxoids.</li> <li>Vaccinate with the suitable combination of 2, 3, 7 or 8-way vaccines for various combinations of clostridial diseases to the left.</li> <li>All beef cattle should be vaccinated for blackleg and malignant edema.</li> <li>To ensure as permanent immunity as possible where the disease has occurred before, all the cattle should be revaccinated annually until they reach three years of age.</li> </ul>

\*Consult a veterinarian to determine your farm's vaccination program.

TABLE 62 *continued*. Summary of vaccination procedures for the control of some infectious diseases in western Canadian beef herds\*

Disease	Time to vaccinate	Remarks
(Continued from page 177)	(Continued from page 177)	<ul style="list-style-type: none"> <li>The necessity for vaccination for the other clostridial diseases depends on the prevalence of each disease in the farm's geographical area.</li> <li>A few cases of infectious hepatitis, bacillary hemoglobinuria and tetanus have occurred sporadically in Western Canada.</li> </ul>
<ul style="list-style-type: none"> <li>Bovine virus diarrhea (BVD)</li> </ul>	<ul style="list-style-type: none"> <li>Heifer calves: 3 to 4 weeks after weaning.</li> <li>Breeding females: 2 weeks before breeding.</li> </ul>	<ul style="list-style-type: none"> <li>A killed vaccine is available for pregnant animals.</li> <li>A modified-live intramuscular vaccine is available for use in open animals that are not in contact with pregnant animals.</li> </ul>
<ul style="list-style-type: none"> <li>Vibriosis</li> </ul>	<ul style="list-style-type: none"> <li>Cows: initial dose about 40 days before breeding season, followed by booster at 10 days before breeding season.</li> <li>Heifers: initial dose about 50 days before breeding, followed by a second dose 10 days before breeding season.</li> </ul>	<ul style="list-style-type: none"> <li>Booster vaccination must be given about 4 weeks after first vaccination and close to time of breeding to ensure a high degree of immunity during breeding period.</li> </ul>
<ul style="list-style-type: none"> <li><i>Histophilus somni</i> complex</li> </ul>	<ul style="list-style-type: none"> <li>Weaned calves: at weaning time or using a pre-immunization program 3 weeks prior to weaning and booster shot at weaning.</li> <li>Weaned calves arriving in feedlots: within 24 hours of arrival.</li> </ul>	<ul style="list-style-type: none"> <li>Booster recommended 21 days later.</li> <li>Recommended for calves 5 to 8 months of age.</li> </ul>
<ul style="list-style-type: none"> <li>Bacterial scours</li> <li>Enteric colibacillosis of calves</li> </ul>	<ul style="list-style-type: none"> <li>Pregnant heifers: twice, 6 weeks and again 2 to 3 weeks before calving.</li> <li>Pregnant cows: 2 to 3 weeks before calving if they had the initial vaccination in previous years.</li> </ul>	<ul style="list-style-type: none"> <li>The initial vaccination in heifers can be given in the fall or winter period.</li> </ul>

\*Consult a veterinarian to determine your farm's vaccination program.

It is also important to know if a sick animal is an isolated case or the start of an outbreak. Knowing this helps you decide if preventive measures need to be implemented.

Pneumonia manifests itself as depression. The ears and head are down and a clear lack of vigour is evident. Also, there will be an increased respiratory rate and in some cases, salivation or slobbering around the mouth.

With many diseases the animal's temperature confirms what you are observing. However, temperature can also fool you as sick cattle may just be getting a fever and extremely sick cattle may have already spiked a high fever, which is decreasing before they die.

For all other disease conditions, owners are the best at knowing and closely observing their cattle. Close observation and careful assessment are necessary before you call your veterinarian. The more clinical signs and history you gather, the better chance you and your veterinarian have at arriving at a proper diagnosis. For example, lameness (mentioned in a subsequent section) can be caused by a large number of conditions other than footrot. Check it out thoroughly before jumping to conclusions. Otherwise, you may be treating the wrong condition, and in some cases, giving the opposite treatment to what is needed.

Through their extensive training, veterinarians are able to recognize or check for health-related production losses and help you customize programs to deal with any problems and meet your specific needs. This is where the most benefit can be gained from the herd health program.

Always seek veterinary advice if you aren't sure what it is you are treating. Your veterinarian will also be able to advise you about conditions where the prognosis is extremely poor and slaughter for salvage is a definite alternative. Remember that with most drug products, once you treat an animal an adequate withdrawal time is necessary before slaughter. The withdrawal time is the interval between the removal of the medicine and the permitted time for use of milk or meat for human consumption.

The clinical signs of many individual diseases are presented in the following section.

## Clostridial Diseases

### Malignant Edema

*Clostridium septicum* and other bacteria cause this soil-borne disease. They enter the body through puncture wounds, surgical wounds or parturition (birthing) injuries that are contaminated with dirt. All ages of animals can be affected with this highly fatal disease that is caused by the absorption of potent toxins from the site of infection into the bloodstream (toxemia).

Clinical signs usually appear within 12 to 48 hours after infection. They are characterized by swellings at the site of infection. The swellings are soft at first and painful on pressure. Later they become hot and firm. They may also contain gas in a mixed infection. The animal is usually very depressed with a high fever [greater than 42C (104F)]. It may also be stiff or lame.

The best treatment consists of antibiotics administered early in the illness, but death often comes within 24 to 48 hours after the disease is detected. As with blackleg, isolation of affected animals and proper disposal of carcasses are advised.

Malignant edema is prevented by a routine vaccination along with the blackleg vaccination. This should be done at least two weeks before any surgery such as castration and dehorning.

### Blackleg

This highly fatal disease is caused by a soil borne, spore-producing bacterium, *Clostridium chauvoei*, which enters the body through the digestive tract or a wound. Usually, healthy, fast-growing animals between six and 24 months of age are affected, especially if they are on a high plane of nutrition. However, cattle of all ages can be involved. The organism invades muscle tissue, causing severe inflammation and systemic toxemia.

Few animals are seen alive with the disease. They are usually found dead. If affected animals are observed alive, severe lameness on the affected limb is the obvious characteristic, along with pronounced swelling (hot and painful at first, but cold and painless later) with gas palpated under the skin and a crackling sound (like crinkling newspaper).

The skin on the affected limb later becomes dry and cracked. There is a high fever and severe depression. In rare cases the organism may affect other muscles such as the diaphragm, tongue or heart.

Treatment consists of large doses of penicillin, but it is usually unsuccessful. Other animals in the herd should be removed from the affected pasture and isolated. Deep burial or burning of carcasses is advised to minimize the contamination of the soil with spores.

Prevention is by means of vaccination. This produces good immunity, which requires 10 to 14 days to develop.

## Other Clostridial Diseases

Other clostridial diseases, such as enterotoxemia (seen in cattle consuming grain) and tetanus (seen in bulls castrated with bloodless castrators), are also diagnosed across Alberta. As a result, veterinarians recommend the 7 or 8-way vaccinations, starting with calves over two months of age. If three shots are given before two years of age, lifelong (at least five years) immunity is obtained. Always vaccinate new purchases if their status is unknown.

## Tetanus (Lockjaw)

A soil-borne organism, *Clostridium tetani* (tetanus), causes this condition. Spores are introduced through wounds and locate in the animal's tissues. Toxins are produced, which irritate the nerves supplying muscles. The muscles then go into spasms. Tetanus affects all animals, including humans, but horses are especially susceptible.

In cattle, tetanus is often associated with surgical castration wounds or injuries of the birth canal following calving. Tetanus has also been reported following castration with bloodless castrators.

The first sign noticed in cattle is a stiff gait. Later, severe muscle spasms occur. These may be brought on by a sudden noise or movement. Death occurs from nerve damage and/or the failure of the respiratory (breathing) muscles.

Treatment includes tranquilization by putting the affected animals in a quiet, darkened stall and

the use of antitoxins and antibiotics. Cleaning and disinfecting the wound is mandatory. Nursing care is also important, as the animal's food should be palatable and easy to swallow.

Prevention includes being careful during any type of castration and calving and removing puncture wound hazards such as nails. Generally, tetanus is included in most 8-way blackleg vaccines as the two diseases are closely related.

## Respiratory Diseases

### Shipping Fever

Shipping fever is the term given to the myriad of respiratory conditions that typically occur at weaning time. It usually has bacterial and viral components. Often large numbers of *Pasteurella* bacteria are found in the lungs. The disease is initiated when stresses such as weaning, shipping, dehorning, castration and cold weather, or a combination of these stresses, compromise (weaken) the immune system, leaving the animal open to infection. In many cases, a respiratory virus infects the stressed animal. This further lowers the respiratory system's resistance to infection by bacteria such as *Pasteurella*.

The organisms involved are spread by inhalation when animals come into close contact with affected cattle. This occurs with crowding or close confinement. An example of this is when previously pastured calves are confined with animals from various origins at auction markets or feedlots.

Animals of all ages are susceptible, but usually cattle between six and 24 months old are affected. Clinical signs include depression, weak cough, rapid, shallow respiration and being off feed. A clear discharge from the nose and eyes is seen early in the infection. It may become thickened and crusty after several days. A high temperature is a telltale sign; often it can be above 40.5C (105F).

The successful treatment of shipping fever depends on early detection, the isolation of sick calves and prompt treatment with antibiotics. Several antibiotics, featuring up to 96 hours of effective treatment levels with only one treatment, have been developed. Consult your veterinarian



to determine the choice of drugs to use in your area, as well as the proper dosage regimen. If more than 10 to 15 per cent of a group is affected with shipping fever, mass treatment of the entire group may be necessary. This can be accomplished with either injectable, long-acting antibiotics or long-term oral medication in the feed or water supply.

With early treatment, cattle usually make a complete recovery. If treatment is delayed, losses are higher and survivors are often unthrifty because of lung abscesses and adhesions. Controlling shipping fever requires good management and the judicious use of vaccines. Since shipping fever is a complex syndrome, several vaccines can be used to control its occurrence. Vaccines for common respiratory viruses like IBR, PI-3 and BVD are available. Consideration should be given to their use as part of an overall preventive program. Vaccines for *Pasteurella hemolytica* and *Histophilus somni* bacteria are also used in combination with the viral vaccines.

Management practices that can help reduce shipping fever include:

- reducing the stresses that initiate pneumonia
- minimizing the stresses of preconditioning (castration, dehorning, vaccinations and parasite treatments) by performing them over a period of time while the calf is still on the cow
- creep feeding calves to help them get used to the ration they will be weaned onto
- weaning when the weather is good and calves have a clean area with lots of good quality feed and good access to clean water
- delaying the transportation of calves to markets for at least four weeks following weaning to minimize the stress and allow the calves to start gaining weight
- direct marketing to minimize transportation stress
- when weaning calves, make weaning their only stress
- providing adequate nutrition (including trace minerals) prior to weaning to ensure high immunity status

## Infectious Bovine Rhinotracheitis

Infectious bovine rhinotracheitis (IBR) is a viral infection of the upper respiratory tract that most often affects the internal structures of the nose and trachea (wind pipe). The virus belongs to the herpes family, the same family as the virus that causes human cold sores. Infectious bovine rhinotracheitis (IBR) is spread by inhaling contaminated droplets of moisture from affected animals. The virus can exist in an animal in a latent form without causing any signs of disease. Later, when the animal is put under stress, the virus is reactivated and may be spread to other animals. This is often the only explanation for an outbreak of the disease in a herd that has been closed for some time.

Cattle of all ages are susceptible, but often it is cattle at weaning that are affected. For several days they will show signs of a high fever, harsh cough, nasal discharge, watery eyes and loss of appetite. Recovery is usually complete in one week, but can be prolonged in feedlot cattle. Some animals may develop secondary infections such as pneumonia.

Abortions often occur following exposure of susceptible pregnant animals to infection. They can occur suddenly at any stage of gestation, but usually occur in the third trimester. Aborting animals do not appear sick.

An ocular form of infectious bovine rhinotracheitis (IBR) can occur in any susceptible class of cattle and usually occurs along with the respiratory form. The discharge from the eyes is clear at first. It then turns white and mucus like, affecting both eyes.

A genital form of IBR produces lesions on the penis that may temporarily interfere with breeding. In cows and heifers, an inflammation of the vulva is seen that often results in a yellowish-coloured discharge that persists for a few days. Cows are quite sensitive in this area. Recovery usually occurs without treatment.

Although antibiotics do not affect the IBR virus, treating animals affected with the respiratory form of IBR with broad-spectrum antibiotics helps control secondary infections like pneumonia.

Control of infectious bovine rhinotracheitis (IBR) is based on both vaccination and management. Three types of IBR vaccines are available in Canada. They include: a modified-live (MLV) vaccine, which must not be used on pregnant animals; an MLV intranasal vaccine, which is safe for use in both pregnant and open cattle; and, a killed vaccine, which is available for use in both pregnant and open animals. The IBR vaccines do not provide protection against the other common diseases of the respiratory tract of cattle such as shipping fever, necrotic laryngitis or pneumonia. However, the vaccines cause the animals to produce interferon, which is a non-specific protector against viral infections.

The following are some general IBR vaccination recommendations.

- Vaccinate the breeding herd including cows, replacement heifers and breeding bulls at least two weeks before the breeding season starts.
- Calves in a pre-immunization program should be vaccinated three to six weeks before weaning. When vaccinating the calves with a modified live intramuscular vaccine before weaning, be sure the dams of the calves have already been vaccinated for infectious bovine rhinotracheitis (IBR). This is done to prevent abortions from occurring after vaccinating the calves.
- Weaned calves and feeders should not be vaccinated during a period of stress.
- In the face of an outbreak of IBR, all pregnant cattle may be vaccinated, but only intranasal or killed vaccines can be used. Consult a veterinarian for vaccination recommendations.
- Infectious bovine rhinotracheitis (IBR) and bovine virus diarrhea (BVD) are the two most common infectious causes of abortion in cattle. Thus, it is always advisable to vaccinate the breeding animals.
- Almost without exception, IBR is given with PI-3 and BVD vaccinations. Breeding heifers are often given the modified-live versions

of these vaccines in order to attain high immunity. These vaccines are given at least two weeks before the breeding season starts. Veterinary advice should be obtained, especially with the use of these modified-live vaccines.

Cattle breeders who are selling purebred stock internationally should be aware that some countries require imported cattle to be negative to any IBR blood test. This would be unlikely in vaccinated animals. Breeders need to carefully assess the risk of not vaccinating as not vaccinating means putting the entire herd at risk to maintain an open avenue for international export.

In a feedlot it is important to avoid exposing newly introduced cattle to other cattle in the lot before the new cattle have developed immunity to IBR. Avoid “topping off” a feedlot pen when some of the cattle have been in the pen for some time. Mixing pens of newly placed cattle with resident cattle in a feedlot is not advised. It is advisable to keep “side by side” pens in a feedlot filled with cattle that have been on feed for the same length of time.

In some cases, long-term feedlot cattle receive a booster for IBR later in the feeding period. Your veterinarian can customize a program specific to your situation.

## Histophilosis Disease Complex

Histophilosis refers to a disease complex caused by the bacterium *Histophilus somni* (in 2005 the bacterium’s name was changed from *Haemophilus somnus* to *Histophilus (H.) somni*). Historically, one form of this disease manifested itself as “sleeping sickness” disease, which is known as infectious thrombotic meningoencephalomyelitis (ITME).

Histophilosis is a syndrome that is relatively exclusive to Western Canada. It takes several disease forms. One form is a respiratory condition that is similar to the shipping fever complex. The other forms it takes are: myocardial infection (infection of the heart) resulting in heart failure; pericarditis (infection of the heart sac); polyarthritis (arthritis of multiple joints) resulting in severe arthritis; pleuritis (infection of lung surface);

and, pneumonia. *H. somni* has also been linked to reproductive problems, infections of the ear, infection of the lining of the eyelid and eyeball and weak calf syndrome.

Infection with *H. somni* can occur in any month of the year and the disease has been observed in cattle as young as one week of age and as old as 10 years. Histophilosis has been seen in beef cow-calf herds and dairy herds. However, it occurs most commonly in recently weaned feedlot calves, (six to 10 months of age), during the fall and early winter. Since the late 1980s, this disease has been reported to be the most significant cause of mortality in fall-placed beef calves in large feedlots in Western Canada. Any recent stress, such as weaning makes the calves highly susceptible. Occasionally, pastured or older animals contract the disease.

The organism is commonly isolated from the genital tract of mature cows and bulls. Many different strains of *H. somni* can be isolated from the reproductive tract, but most do not cause disease. It is not known which strains of the bacterium or which environmental conditions increase the risk of the disease, or why different forms of the disease occur.

If *H. somni* enters the brain, it causes infectious thrombotic meningoencephalomyelitis (ITME). ITME is an acute disease, with most cases found as sudden deaths overnight. Clinical signs include muscular weakness, knuckling over of the rear fetlocks, transitory fever and a lack of co-ordination, paralysis, appearing to be blind and being unable to stand up. An affected animal lays flat on its side, with its neck extended and head tilted backwards. ITME occurs most commonly three to four weeks after calves enter the feedlot in the fall. Calves with ITME are most often found dead in their pen, or they die within two days of treatment. Those calves that die typically have hemorrhages in the brain.

A postmortem is required to confirm the diagnosis of histophilosis. Veterinarians study the brain, joints (especially the stifle), lungs and heart. Laboratory assistance may be required to observe microscopic abscesses in the brain.

Early treatment of affected animals (before they have gone down) is usually successful. However, animals not treated within a few hours of the onset of clinical signs may not respond to therapy. The prognosis is poor for animals found down and unable to get up.

Once histophilosis disease has been diagnosed, all exposed animals should be checked every few hours to detect new clinical cases. If clinical signs are observed, therapy should be started quickly. In some situations, it may be valuable to medicate the feed for calves or give mass injections of antibiotics. This should be discussed with a veterinarian.

Vaccines against infection by *H. somni* are currently available, but their effectiveness in reducing mortality in feedlot calves has not been well documented. Prophylactic antimicrobial medication of the starter ration has been shown to be the most useful preventive therapy for in reducing death losses from histophilosis. Histophilosis continues to be the number one cause of feedlot deaths and chronically sick animals in Western Canada.

## Viral Pneumonia of Calves

As the name implies, a virus causes this form of pneumonia. Several different viruses may be involved in an outbreak of viral pneumonia and complications by bacteria are common. Calves from two to six months of age are the most susceptible. Predisposing factors include overcrowding, high relative humidity, draftiness and malnutrition. Insufficient colostrum after birth may lead to an increased susceptibility to pneumonia in calves at four to eight weeks of age.

Viral pneumonia usually occurs as a herd problem. Individual animals have high fevers, nasal discharge, rapid respiration and a dry hacking cough. Most calves recover spontaneously in four to seven days, if there is no secondary bacterial invasion. If secondary bacterial invasion occurs, the death losses will be high without antibiotic therapy. Antibiotics are ineffective against viruses.

Good management is important in controlling viral pneumonia. Provide adequate shelter and good nutrition for calves and avoid overcrowding. Ensure that newborn calves receive at least 1 to 2 litres (L) (1 to 2 quarts) of colostrum within the first two hours after birth and a further 2 L within the next six to eight hours.

Producers can vaccinate for most viral pneumonias (IBR, PI-3, BVD and BRSV; see other sections of this chapter for descriptions of these diseases). BRSV has gained notoriety as a sudden killer. Early symptoms are frothing at the mouth with a rapid respiratory rate. Producers who have experienced difficulties with this disease should vaccinate the cows in order to pass the protection into the colostrums. Autopsies to determine the cause, especially if pneumonia is suspected, should be done in all cases of sudden death.

### **Calf Diphtheria (Necrobacillosis)**

Calf diphtheria almost exclusively occurs in young cattle (less than one year of age). The organism gains entry through abrasions in the mouth or larynx (voice box).

When the disease solely involves the voice box, it is called necrotic laryngitis. The larynx becomes infected, swells and in some cases forms an abscess. A loud snoring or whistling noise can be heard when the animal breathes because the opening is greatly restricted. Both coughing and swallowing are painful. Extended neck breathing using the abdominal muscles is quite evident. On touch, the throat area feels swollen and is painful. Excessive salivation is common, along with a nasal discharge. Most calves will have a high fever and foul breath.

Early treatment is important to avoid serious complications and achieve a good response to therapy. Sulphonamides, penicillin and tetracyclines all achieve good results when used in combination with anti-inflammatory drugs during the first few days. Calves with severe necrotic laryngitis may require surgery (tracheotomy) to prevent asphyxiation and to allow the larynx to heal. If surgery is performed, the recovery rate is 50 per cent. Thus, medical treatment is preferable and surgery is a last resort. The length of treatment should be quite long, upwards of 10 days. Shorter treatment periods commonly result in relapses.

Calves that break ribs as a result of being pulled backwards can develop similar symptoms. As the ribs heal they compress the trachea. These calves are unresponsive to treatment and have to be destroyed.

### **Atypical Interstitial Pneumonia (AIP)**

This disease is also known as pulmonary emphysema or fog fever. It is associated with a number of factors that include mouldy feeds, dusty hay and moving cattle from a dry or overgrazed pasture to a new or lush pasture in the late summer or fall. AIP is thought to be an allergic lung reaction. Recent studies suggest that high levels of D, L tryptophan in forage cause the disease. D, L tryptophan is converted in the animal's rumen to a chemical that affects the lining of the lungs.

Animals may suddenly be found dead about four days to two weeks after moving to new pasture. Other animals will have laboured breathing, often breathing through their mouths. Their heads will be extended and they will have froth at the mouth. The body temperature of the cattle is normal or only slightly elevated. Even during an outbreak, the incidence of the disease in a herd will be low, but animals that do contract the disease have a very high fatality rate. The disease is progressive, with very poor response to therapy.

There is no specific treatment for AIP. Removing a herd from an affected pasture does not seem to have much influence on the number of animals that become ill. If animals are to be removed from the pasture, move them slowly. Avoid exciting or chasing the affected animals. Recent work with feedlot animals at the Lethbridge Research Centre showed a higher rate of loss in heifers on melengestrol acetate (MGA<sup>®</sup>, used to suppress estrus or heat in feedlot heifers). Ionophores fed in the diet seem to reduce the occurrence of the condition. Adrenalin, corticosteroids or antihistamines may provide temporary relief, but a veterinarian should be consulted as soon as possible. Slaughter is often the only method of salvage for severely affected animals.

The key to reducing the risk of AIP on pastures is grazing management. Before turning cattle onto lush pasture, they should be fed with dry feed such



as straw or hay. Avoid mouldy feeds. Moisten dusty feeds before feeding. Limit access to the lush pasture to one to two hours at first and then supplement with dry feed. Over a period of a week, gradually increase the time the cattle are allowed to graze until they are on the pasture full time. Observe animals closely when they are moved to a new pasture.

Atypical interstitial pneumonia is sometimes confused with nitrate poisoning. Your veterinarian will be able to distinguish between the two for you. AIP is also sometimes confused with low levels of lungworms.

## Diarrhea Diseases

### Calf Scours

Bacteria, viruses, protozoa or nutritional factors can cause diarrhea in young calves, but usually it is caused by a combination of these agents in association with stress in the form of cold or overcrowding. It is most common in calves under 10 days of age, especially in those that have poor colostrum immunity (see the *Colostrum* section in the *Calf Management* from Birth to Weaning chapter).

The diarrhea varies in colour and severity, depending on the cause. Affected calves are usually depressed, weak and dehydrated, which is shown most dramatically by sunken eyeballs. Death can occur in a few hours, but usually takes several days even for severely affected calves.

### TREATING SCOURS

Successful treatment of scouring calves requires early detection. It is necessary to keep a frequent check on the herd. Consult a veterinarian for specific recommendations.

Identify scouring calves and isolate them from the rest of the herd. This helps to prevent the spread of infection and makes it easier to determine when a calf started to scour and how many times it has been treated. Always change



*AIP animal with laboured breathing.*



*AIP animal with few visible signs.*

your coveralls, wash your hands and scrub all organic material off of your boots and rinse them before moving to another group of calves. Treat scouring calves last.

Treat scouring calves with antibiotics. Give antibiotics by injection, instead of by mouth. Administer them for at least three days to minimize relapses. Antibiotics are beneficial only when treating scours caused by bacteria such as *E. coli*. Often, however, it is not possible to determine clinically whether the cause is bacterial or viral. As well, infections in calves are commonly mixed; that is, bacterial and viral. The possibility that intestinal bacteria will enter the bloodstream is reduced if antibiotics are administered to affected calves. If the diarrhea is viral in nature, the antibiotics prevent secondary bacterial invasion. Several safe and very effective antibiotics have come out for scour treatment in the last several years. Your veterinarian can best advise you as to which to use. In the case of bacterial scours, your veterinarian may even culture the organism to determine specific sensitivity to various antibiotics.

The most important therapy for scouring calves is the replacement of lost body fluids with electrolytes such as sodium, chloride, potassium and bicarbonates. Several good commercial electrolytes are available. Some include dextrose (energy) as well. To assess the amount of dehydration present, observe the sunkenness of the eyes and the elasticity of the skin, especially the eyelids. The eyes start to sink at six per cent dehydrated. In severe cases, where the calves lie flat out and are unable to get up, the calves are eight to 12 per cent dehydrated. In these cases fluids must be administered intravenously using sterile equipment and solutions. It is important to

carefully calculate the rate and volume of fluids. Therefore, a veterinarian should supervise or actually administer the intravenous electrolyte solution. Severely dehydrated calves also need to be warmed up and given drugs for shock.

For less severe cases, scouring calves can be treated successfully using oral electrolyte solutions. It is simple to use an esophageal feeder or nipple bottle (if the calf is strong enough to suck) and it does not require sterile equipment. Be sure to only use that feeder and nipple on scouring calves, not on newborns. The equipment should be cleaned and disinfected after use on each calf. Commercial electrolyte solutions are readily available. It is not advisable to make your own solutions. Slight miscalculations can lead to salt poisoning or severe electrolyte imbalances. Consult your veterinarian to make sure you are using products that contain adequate levels of electrolytes and glucose.

Depending on the calf's size and degree of dehydration, a scouring calf may need up to 4 to 5 L (0.9 to 1.1 gal.) of fluids to rehydrate. Extra fluid will be required to replace the continuing loss of body fluids and electrolytes, perhaps an additional 4 to 5 L (0.9 to 1.1 gal.) per day. It is advisable to give 1.5 to 2 L (0.3 to 0.45 gal.) of fluid every six to eight hours, until the diarrhea stops.

In individual cases, where the cow can be milked out and left with the calf, it may be helpful to restrict the milk intake of calves for 24 hours following the onset of diarrhea. Milk should only be taken away from a calf for 24 hours because after that length of time the calf will lose considerable weight if milk is not part of the diet. This procedure is not recommended during scour outbreaks as it is not practical to milk out all the cows. Also, it causes considerable stress to separate the calves from their mothers.

## PREVENTING SCOURS

The prevention of scours is preferred to the treatment of scours. Pre-calving prevention involves managing the cows and heifers. After-calving prevention shifts to managing the newborn calves to prevent the spread of the disease. Herd size, availability of facilities and labour and general management techniques differ between operations. However, some broad management

principles can be adapted and integrated into your operation that may improve prevention in your calving facility. One key to successful prevention is to keep it simple or as natural as possible. Keep abreast of new developments and keep thinking how to adapt them to your operation. Learn from other knowledgeable producers and from the mistakes of others. Develop an action plan for before and after calving with your veterinarian for preventing and controlling the disease.

## Factors that increase the risk of scours

Whether a pathogen (a disease-causing micro-organism) causes a disease or not depends on its disease-causing ability, the number of organisms the calf is exposed to and the amount of antibodies carried by the calf (strength of immunity). Many pathogens that cause disease in calves are carried by the cows. Those pathogens will be in the calf's environment when it is born.

One of the most critical factors determining the occurrence and severity of scour outbreaks may be the amount of usable space available to animals during the wintering and calving period. Severe crowding or crowding for long periods of time increases the contamination of the newborn calf's environment. The buildup of environmental contamination becomes more severe as crowding increases. If all the cows are crowded in an area that also serves as the maternity area, the calf will be exposed to a greater number (dose) of pathogens that may overwhelm its natural colostral immunity and the protective effect of any vaccines.

Crowding also increases the amount of stress on the animal, particularly newborn calves. Stress can reduce a calf's ability to fight disease. In crowded conditions, newborn calves may have difficulty finding and nursing their dams, so they may not ingest sufficient colostrum. The older cows may also interfere with the normal nursing pattern of calves born to heifers. When not nursing, newborn animals normally spend most of their time sleeping. However, in crowded conditions, they may find it difficult to locate a quiet, comfortable resting place where they will not be trampled and bunted by other animals. Calving inside barns, sheds and shelters increases the risk of scours, even if calves are turned out before one day of age.

Other stress-related contributors to serious disease outbreaks include extremely cold weather, wet cold weather, wind chill, lack of food and pain. Outbreaks of diarrhea frequently follow cold weather that is accompanied by wind and snow or rain. Bad weather may increase stress and alter the nursing pattern of calves. As well, animals may crowd together as they seek shelter from the weather.

Excess water on the ground not only makes it difficult for calves to find a comfortable place to sleep, but also may transmit infectious agents. Conversely a dry, frozen or snow-covered surface may decrease the amount of contamination. Excess water can occur during spring thaw or following spring storms, and is often worsened by improper location of calving grounds.

The risk of scours is higher if the calf receives an insufficient amount of colostrum and/or poor quality colostrum. First-calf heifers have a lower quantity and quality of colostrums. As a result, the incidence of scours is usually at least twice as high in calves from first-calf heifers than calves from older cows.

## PRACTICES TO PREVENT SCOURS

**Vaccination:** Vaccinating the cow against the diseases that may threaten the newborn calf enhances the protective antibodies of the colostrum. Your veterinarian may recommend vaccinating the cows and heifers against the most common scour-causing organisms prior to the calving season. Or, based on past performance, the vet may deem it necessary to only vaccinate the bred heifers. Each farm is unique. It is important to develop a scours protocol that best minimizes scour incidence for your operation. Vaccinations should be given to any newly purchased bred females. Read the vaccine directions carefully and give the vaccine at the proper time to maximize antibody production.

With the risk of major losses due to scours each year, most producers now vaccinate. Even calves that fully recover from scours will be about 45 kg (99 lb.) lighter at weaning time. Others become poor doers as a result of intestinal damage. Vaccination is especially important for producers with over 200 cows, producers whose herd has a history of scour problems and producers who calve in close confinement.

Several companies now manufacture multivalent scour vaccines. Most vaccines provide protection against *E. coli* bacteria and *rota* and *corona* viruses. These are the three most significant causes of scours in Alberta. Give two shots in the first year, and then a yearly shot ideally two to three weeks before the calving season starts. This achieves maximum antibody levels in the colostrum to combat the scour organisms. Ideally, your frozen colostrum source should come from vaccinated cows.

**Biosecurity:** In recent years more cases of salmonella scours have surfaced in Alberta. Prior to this, salmonella scours, especially in confinement reared dairy calves, was seen mostly in warmer climates such as British Columbia. Clinical signs consist of a bloody diarrhea in calves that are more than a week old. These cases are unresponsive to antibiotics and pneumonias are often associated with the diarrhea. Recently purchased cows are often the source of the problem. Strict biosecurity measures are necessary. Remember that salmonella is transmissible to humans.

Cryptosporidiosis is another rare form of scours that is unresponsive to antibodies. It is transmissible to humans and can contaminate drinking water. Calves that develop cryptosporidiosis are often immunosuppressed.

**Stimulating passive immunity:** In the face of scour outbreaks, veterinarians may explore the options of oral products to stimulate specific passive immunity, as provided by colostrum. Specific products have been formulated for *E. coli* scours or the viral ones (*rota* and *corona*). These are given orally to calves right at birth.

**Winter heifers and cows separately:** Winter first-calf heifers and mature cows separately. Each group has significantly different nutritional requirements because heifers are still growing. If the first-calf heifers and mature cows are wintered together, the mature cows will get more than their share of nutrients while the first-calf heifers will get less. Cows that are too thin or under-conditioned (BCS less than 2.5) or over-conditioned (BCS greater than 3.5) can have more calving problems, poor colostrum and milk production and more breeding problems in the subsequent breeding season.



### Prepare and maintain the calving area:

When calving on range, locate calving grounds where there is some natural shelter and a windbreak. If semi-confinement calving is necessary, make sure some high ground, with good drainage and a southerly exposure, is available.

Monitor snowfall throughout the winter and anticipate excess snow buildup. Begin snow removal early. Plough strips 6 to 7 m (20 to 25 ft.) wide at least once before the onset of calving. Also, clear spaces that can be used for feeding and loafing areas. Cleared areas should have a southerly exposure and be on elevated ground to avoid the accumulation of water when the snow melts. Turn the cattle into these areas as soon as the weather permits. Place feed and water in a manner that encourages cattle to disperse.

Provide clean, dry bedding regularly so the cows' udders and underbellies stay clean and the calves have a dry, comfortable place to sleep. Increased sanitation is probably the best way to reduce pathogen contamination and prevent scours. If one section of the maternity area becomes contaminated or the drainage is poor, fence it off until conditions improve. As more ground becomes bare, increase the amount of space available to animals.

### SUMMARY OF PRACTICES TO REDUCE THE RISK OF SCOURS

- Provide proper wintering rations to ensure that cows and heifers are in good (BCS 3) body condition and good health at calving.
- Try to winter cattle in different areas to help spread manure and give the cattle exercise.
  - This will help keep the environmental load of pathogens at the lowest possible level, especially in the area where the calf is born.

*A clean, dry calving area reduces disease.*



- If scours is a recurring herd problem, your veterinarian may recommend vaccinating first-calf heifers and cows against the most common scour-causing organisms prior to the calving season.
  - Vaccinate the herd six and three weeks before calving.
- Do not calve heifers and cows together.
  - Save separate areas specifically for calving heifers and cows.
  - Provide at least 185 m<sup>2</sup> (2,000 ft.<sup>2</sup>) of calving space per heifer. That equates to no more than 20 heifers per acre.
  - If the weather permits, do not confine cows for calving.
  - If cows and first-calf heifers calve together, the entire herd must be confined so that the heifers can be more closely watched and assisted at calving.
- Avoid calving in muddy areas and areas with a high accumulation of manure.
- Check calving cows and heifers regularly and provide assistance when needed.
  - Provide a sheltered area where assistance may be given.
- Supply clean and dry bedding, and provide access to natural or artificial shelter when the weather is bad at calving time.
  - Provide portable calf shelters on pasture to keep calves dry and protected from chilling winds.
  - These sheds should be moved or cleaned out periodically.
  - Work to keep the calving areas clean and dry, especially the calving barn.
- Remove bedding frequently.
  - Avoid the use of barns or sheds for prolonged periods.
- Avoid overcrowding and prolonged confinement of cattle during both the wintering and calving periods.
  - Fifty cow-calf pairs per pen or confined wintering area is the maximum.



- Another way to avoid overcrowding during calving is to have cow-calf pairs in more than one pasture or calving area during the calving season.
- If semi-confinement is necessary, reduce the population density in the immediate calving area.
  - Do this by dividing the main herd into smaller groups based on anticipated calving dates or by rotating expectant dams through the calving area.
- Disperse the calved-out animals as soon as the weather permits. In addition to decreasing population density in the calving area, calving and dispersing calves in groups is believed to greatly reduce stress.
- Minimize the stress on newborn calves. Sources of stress for newborn calves are a lack of adequate energy supply (milk); cold, damp and windy weather; and, crowded conditions.
- Plan a course of action with your veterinarian and implement it immediately when the first scours case occurs.
- Any calf that shows signs of illness should be moved with its mother to a sick pen/hospital area for evaluation and treatment.
- If a weak calf is born, help it to stand and nurse early, or be sure it is fed colostrum using a nipple bottle or esophageal feeder.
- Provide extra care for weak calves. Separate weak calves from the herd for several days until you are sure they are strong and healthy.
  - A weak calf that develops scours may be the start of an outbreak.

## Coccidiosis

Coccidiosis is an acute or chronic disease caused by small single-cell parasites, *Eimeria sp.* Cattle acquire the parasites as eggs taken in with fecal contaminated food, water or soil. The parasites multiply in the large gut lining, often causing serious damage. Young animals, whether on pasture or in feedlots, are the most commonly affected.

This disease suppresses the immune system, allowing calves to succumb to other diseases.

One type of coccidiosis is seen in the summer and is associated with the normal development of the parasites. Another type of coccidiosis is seen in the winter and is believed to be stress related. It causes nervous symptoms, which include muscular tremors and convulsions. Scientists don't understand why, but somehow the brain is affected. They have coined the term "nervous coccidiosis" for these cases. The response to treatment is very poor. Prevention is the best bet.

Coccidia are natural inhabitants in the guts of all cows, and they seed the environment for young calves. Since the oocysts (parasite eggs) survive through the winter, they concentrate in water puddles during the spring runoff. Young calves drink from these puddles and become infected. Thus, the incidence of the disease is especially high in crowded calving areas during a wet spring.

Clinical signs include bloody diarrhea, a bloodstained rear end, excessive straining, weight loss and dehydration with anemia. In severe cases, death can result. Straining is often excessive enough to prolapse the rectum. If prolapsed, the rectum must be sutured in. Diagnosis of coccidiosis is done by examining the feces of an affected animal for oocysts or through postmortem examination. Fecal exams can help you to determine the level of oocysts in your calves.

The life cycle of the parasite is short (21 to 28 days), so multiplication of the parasite is fast. Clinical signs can develop within a couple of weeks, once damage to the intestine occurs. In subclinical cases (where clinical signs are not observed), coccidiosis can substantially reduce weight gains.

Several drugs are effective against the parasite when it is still in the gut lining, but the drugs must be given before or just as signs of the disease are observed. Treating cows with the ionophores Rumensin® and Bovatec®, either in a complete ration or minerals, substantially reduces fecal shedding or is a good preventive measure. This treatment is especially effective if it is started in the fall, prior to calving. Another preventive measure is the early introduction of calves to creep feed with Deccox®. Deccox® is a specific coccidiostat that treats coccidia infection.

Management practices to lower the risk of coccidiosis include:

- avoiding stress, overcrowding and the contamination of feed and water supplies with feces
- properly disposing of manure on a yearly basis
- keeping calves in a well drained area

Good management and early diagnosis are important in reducing the losses associated with this disease. The first clinical case is usually the tip of the iceberg. It is important to remember to isolate affected animals as they are shedding millions of the organisms. Prevention for the herd is the key. It is also important to consult a veterinarian.

### **Johne's Disease (Paratuberculosis)**

Johne's disease (pronounced "Yo Knees") has been around for decades, but countries around the world are just now starting to implement control programs. In the past, this disease has been confused with hardware disease and cows have been mistakenly treated.

Johne's disease causes persistent diarrhea, with the consistency of pea soup. The infected cattle progressively lose weight while continuing to eat. The eventual outcome is death, although it usually takes several months.

This tuberculosis-like disease has an incubation period of at least two years. You never see clinical signs in immature animals. During the winter, a large ice-manure ball forms on the end of the tails of infected mature cattle. Less than five per cent of infected carriers develop signs. Individuals acquire the organism over time from the environment. Those with clinical disease shed billions of organisms daily in their watery manure. Some lactating cows even pass the organism through their milk.

Younger calves are the most susceptible. separating heifer calves from clinically affected cows is recommended.

To disinfect contaminated areas, producers should spread the manure on grain land and spray the contaminated area with a five per cent formalin solution.

Veterinarians suspect Johne's disease when a cow has chronic diarrhea, yet continues to eat. Immediate slaughter is often recommended for two reasons. If the animal is shipped to slaughter before severe emaciation results, the producer will receive some or full compensation. Shipping also results in less environmental contamination to affect the rest of the herd.

It is difficult to diagnose Johne's through lab testing on live animals as some blood tests are not specific and fecal culture takes over six weeks to complete. These tests are both costly and time consuming. Diagnosis in a dead animal is easily confirmed. Johne's is identified by the thickening of the small intestine. The small intestine can also be examined microscopically to determine presence of the organism.

In 2001, under a voluntary program, the Alberta Government began accrediting veterinarians to test for this disease. The health of Canada's export market depends on producers ensuring a low incidence of this disease. Thus, it is important for producers to quickly identify animals with chronic diarrhea. A veterinarian can check the animals in question, help identify the problem and ultimately reduce the incidence of Johne's disease in Alberta.

Watch for updates about this disease in the agricultural media. Johne's disease may prove to be of worldwide importance in coming years.

## **Nutritional Problems - Metabolic and Rumen Diseases**

### **Bloat (Frothy and Free Gas)**

Bloat occurs when the normal eructation mechanism (belching) is impaired or inhibited and the rate of gas production exceeds the animal's ability to expel the gas. Gas is a normal product of rumen fermentation, but when it forms more quickly than it can be eliminated from the rumen, bloat can develop very quickly. There are two types of bloat: free gas bloat and frothy bloat.

Free gas bloat may be caused by an obstruction of the esophagus or an over-filling or paralysis of the rumen that prevents the rumen from contracting properly. A rapid change in feed or irregular feed intake may cause free gas bloat, because the micro-organisms in the rumen do not adjust quickly enough to the change. When an animal is bloated with free gas, the gas pocket is usually easy to locate with a stomach tube. The expulsion of gas through the tube provides immediate relief from the bloated condition.

Free gas bloat in a feedlot animal is more sporadic than frothy bloat, and usually affects a few animals rather than a large number. Calves are more prone to chronic free gas bloat than are older animals. There is no obvious association with the type of feed used or with pathological problems. Animals that exhibit free gas bloat at an early age often outgrow the problem.

Diet causes frothy bloat (also called pasture bloat, legume bloat or feedlot bloat). Legume or pasture bloat most often occurs when animals graze legume forages. It also occurs infrequently when animals consume dry legume hay or grain. In frothy bloat, the belching mechanism is commonly inhibited by frothy or foamy rumen contents. Soluble proteins in the legumes are released in the rumen during fermentation, producing foam that traps the fermentation gases and prevents the animal from belching or burping. The gas remains trapped in the rumen fluid, forming an emulsion of small bubbles about 1 mm (0.004 in.) in diameter. The frothy rumen contents expand, filling the rumen cavity and inhibiting the nerve endings that control the opening into the esophagus.



*Rumen contents from an animal with frothy bloat.*

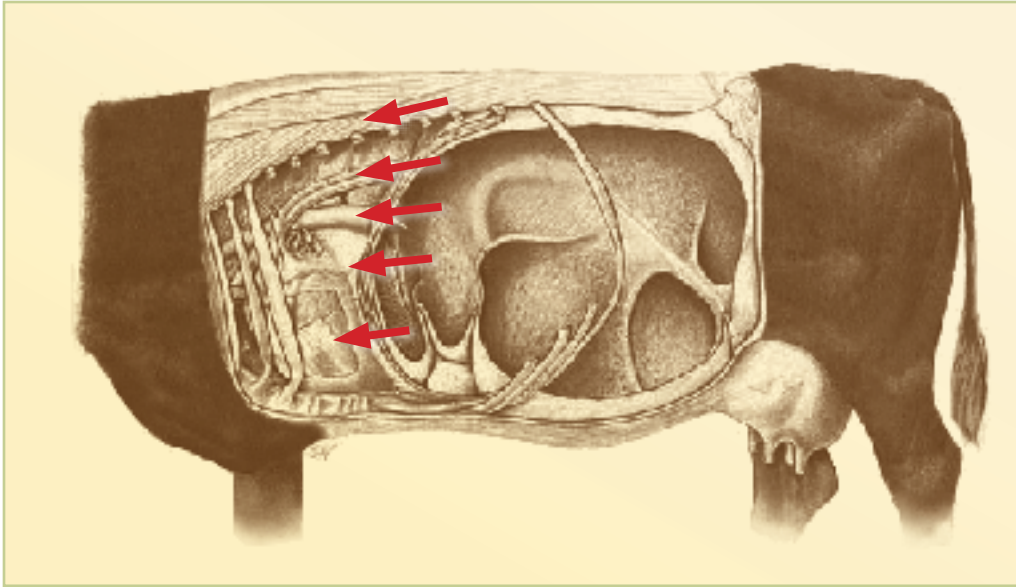
Feedlot bloat is a form of frothy bloat that occurs when animals are on a high-grain, low-roughage diet causing a change in the fermentation in the rumen and production of foam or slime that prevents the normal elimination of the fermentative gases.

Although frothy rumen contents are characteristic of both legume or pasture bloat and feedlot bloat, the physical and chemical explanations for the two conditions vary. Majak et al. (2003) developed a unified theory of frothy bloat that recognizes the similarity of factors observed when pasture and feedlot bloat occur (Table 63). The similar features are: readily digested feedstuffs, diets high in grain or fresh immature alfalfa and an abundance of small particles in the rumen contents. Small particles and slime produce a frothy bloat complex when gas bubbles, produced as feed digestion continues, become trapped in the slime-particle mix.

TABLE 63. Similarities between alfalfa pasture bloat and feedlot bloat

Feature	Feedlot bloat	Alfalfa pasture bloat	Function
Readily digested feedstuff	High-grain ration	Fresh immature alfalfa	Energy source for bacterial growth and rapid slime and gas production
Small particles in rumen content	Fine grain particles	Alfalfa chloroplast particles	Small particles add to slime matrix
Viscous rumen contents	Microbial slime	Microbial slime	Matrix to trap particles and gas





**FIGURE 55.** How animals die from bloat.



**FIGURE 56.** Appearance of dead animal caused by frothy bloat

The clinical signs of bloat are obvious and feature various degrees of distension to the left side of the abdomen, although the whole of the rumen can be enlarged. As the rumen distends, pressure on the diaphragm and lungs increases (Figure 55) until the air supply is restricted, resulting in death by suffocation. An affected animal is also nervous, kicks at its belly and often lies down, only to immediately get up again. Death can occur within several hours, if the boat is not relieved (Figure 56).

Treatment depends on the type and severity of the bloat. Passing a stomach tube into the rumen can relieve free gas bloat quickly. Frothy bloat must be relieved by orally giving anti-foaming agents,

such as dioctyl sodium succinate or mineral oil. The animal must be kept up and walking and removed from feed. Often within 15 minutes the bloat will begin to regress. If the animal goes down, emergency trocarization (stabbing) must be performed. This is done to the left side, where the bloat is the highest. It allows the foamy contents to be expelled under a great deal of pressure. Keep the tube unplugged until the pressure is relieved.

After-effects in these

animals are often minimal, but antibiotics may be used to prevent infection in the wound.

Some animals become chronic bloaters. In these cases, give them rumen stimulants such as probiotics that contain the necessary bacteria for the rumen. If several treatments with these stimulants fail, veterinarians will often perform a minor surgery called a rumen fistula to create a permanent hole between the rumen and outside. This allows the gas to continually escape.

Avoid frothy bloat by keeping animals from grazing susceptible pastures early in the morning, when the pasture is wet with dew. Feeding cattle dry non-legume hay before turning them out to pasture also helps. If alfalfa pasture must be used, then coarser, more mature alfalfa is safer. Another management alternative is to seed a reduced bloating alfalfa cultivar. Agriculture and Agri-Food Canada research centres in Lethbridge and Kamloops have developed a reduced bloat alfalfa, AC Grazeland, which was released in 1997. This variety reduced bloat by an average of 56 per cent when compared to Beaver, a parent cultivar. However, no difference was detected when AC Grazeland was compared to Alfagrazer, a cultivar selected for grazing tolerance. In the near future a non-bloating alfalfa may be developed.

Always keep bloat treatments handy in case of an emergency. Over the years, several products and



management factors have been discovered that feature bloat prevention as a side benefit. Options include the following:

- Ionophores, which aid in growth promotion, coccidiosis prevention and feed efficiency, have also been reliable at decreasing the incidence of bloat. A slow-release, large bolus (pill) has been developed to release a defined amount of Rumensin® on a daily basis. In situations where the risk of bloat is high, using the bolus has proven to reduce bloat incidence by 80 per cent. It protects livestock for 100 days and has the added benefit of growth promotion. Ionophores (Rumensin® and Bovatec®) have also been added to mineral mixes with good results. Check with your veterinarian to determine which method to use.
- Bloat Guard®, when mixed in grain at the rate of 4 to 8 g of Bloat Guard (2 to 4 g poloxalene) per 100 kg (220 lb.) of body weight and fed in two daily feedings, has also helped to prevent pasture bloat. However, it does not have the other benefits that ionophores have.
- Alfasure®, a new water-soluble product manufactured in Alberta, is available for bloat control on a prescription basis from a practising veterinarian. Alfasure contains an antibloat detergent that is effective for preventing bloat.
- Maintaining a coarse particle size of feed controls feedlot bloat most effectively. Feeds with a coarse particle size have other advantages over more finely processed feeds, such as greater and more constant feed intake, reduced wind loss and less irritation from dust to the animals and the feedlot operator.
- When bloat occurs, a change in the source of feed can often control the bloat. The removal of beet pulp or molasses from total mixed rations can also control bloat immediately.

For more information on grazing legume pastures and bloat prevention, refer to the *Nutrition and Feeding Management* chapter in this manual.



*Rumen contents from an animal with grain overload.*

### **Grain Overload (Carbohydrate Engorgement)**

Grain or rumen overload develops when too much grain is provided to cattle too quickly. Before the rumen micro-organisms can adapt to the higher levels of carbohydrates in the ration, fermentation of a large amount of starch takes place, producing excessive lactic acid. The acid is absorbed into the bloodstream, poisoning it.

Grain overload is associated with several digestive disorders and may result in clinical and subclinical acidosis, liver abscesses or bloat. These conditions may occur singly or in combination.

Grain overload is a common problem in feedlots when animals are put onto full feed too quickly, or when errors are made in the ration. Individual cases may also occur where, due to limited bunk space, an aggressive animal consumes more than its share of grain. Accidental overload occurs when livestock gain access to a grain bin or other feed storage areas.

Signs of overload may occur within six to 12 hours, depending on the form (whole versus ground) and the amount of grain consumed. The signs vary from the animals being off feed with diarrhea to being weak and staggering with a bloated appearance. More severely affected animals usually have profuse diarrhea and sunken eyes (due to dehydration). The degree of bloating depends on the amount of grain consumed.

Treatment of this condition depends on many factors including the number of animals affected, amount of grain consumed (if known), value of the animals and stage of the disease. Consult with a veterinarian as soon as possible about how to best handle the situation.

Mildly affected animals may not require any treatment other than the removal of grain from their ration for several days. More severely affected animals may require the administration of oral antacids with a stomach tube. If a large amount of grain is consumed by a limited number of animals, it may be possible to remove the grain through a surgical incision into the rumen (rumenotomy). However, if a large number of animals are involved, quick slaughter may be the best alternative. Consult with the veterinary inspector at the intended slaughter plant.

Intravenous fluids are beneficial for correcting the severe dehydration and acidosis that occur in these animals. The key to success in dealing with any outbreak of grain overload is to start treatment early. When large amounts of fermented material enter the intestines and start to be absorbed, the chances of successful treatment decrease. Remember that affected cattle should not be treated with antibiotics in case slaughter is necessary.

Additional treatment may be needed to prevent founder (laminitis). Long-term cases can sometimes develop fungal infections due to the scarring to the rumen from the acid. They may need to be shipped for slaughter. Liver abscesses can also result (see the *Abscesses* section in this chapter). In extreme cases of grain overload, benefits may occur if commercially available rumen micro-flora is reintroduced to establish a healthy rumen micro-flora population.

To prevent grain overload, ensure bunk space is adequate, rations are properly mixed and feeder cattle are started on rations consisting of at least 60 per cent roughage mixed with grain. After seven to 10 days, the amount of roughage can be gradually reduced by about 10 per cent every four to five days (to a level of no less than 10 to 15 per cent of the ration).

Other preventive measures include carefully sealing all grain storage facilities and making sure that sick calves start back on grain slowly.

## Nitrate Poisoning

Nitrate toxicity comes most commonly from plant and water sources. The accumulation of nitrates in plants is greatest in the stalks. Fertilizers such as ammonium or potassium nitrate are sources of nitrates to both plants and animals. Water draining from manure piles and nitrate-fertilized soils draining into dugouts can be sources of poisoning. Nitrates are more likely to accumulate in annual forages than in perennial crops. Freezing and hail-damage cause the accumulation of nitrates in crops, especially oats. Nitrates in crops are also a concern immediately following a period of drought or wet, dull weather.

Ruminants easily convert nitrates into nitrites, which are quite toxic. The nitrites oxidize the blood hemoglobin to methemoglobin. It is then unavailable to transport oxygen through the blood.

Poisoning usually occurs within hours of ingestion. Symptoms include rapid breathing, slobbering, muscular weakness, abdominal pain and muddy discoloration of the mucous membranes and whites of the eyes. If the intake of nitrates is high, the animal will die after a brief coma. On occasion, symptoms are not apparent until four to five days after ingestion of nitrates. The symptoms in these cases include unthriftiness and increased susceptibility to illness. Low level poisoning can lead to abortions because the fetus does not receive adequate nutrition.

If nitrate poisoning is diagnosed, your veterinarian will give methylene blue (a dye) intravenously as an antidote. Through a chemical process, the methylene blue converts the methemoglobin back into hemoglobin, which allows the blood to again transport oxygen. This treatment may need to be repeated if symptoms reoccur.

The most effective preventive measure is to have feeds analyzed for nitrates. Depending on the analytical procedure used, nitrate levels may be reported in three different ways: nitrate ( $\text{NO}_3$ ), nitrate-nitrogen ( $\text{NO}_3\text{-N}$ ) or potassium nitrate ( $\text{KNO}_3$ ). Be sure you know which analysis method was used before trying to interpret the results (Table 64).

TABLE 64. Method of nitrate analysis and data reporting

Category	% NO <sub>3</sub>	% NO <sub>3</sub> -N	% KNO <sub>3</sub>	Remarks
1	0.5	0.12	0.81	Generally safe
2	0.5 - 1.0	0.12 - 0.23	0.81 - 1.63	Caution - some subclinical symptoms may appear
3	1.0	0.23	1.63	High nitrate problems - death losses and abortions can occur

Note: The values quoted above are on a dry (moisture-free) basis.

Most feeds that contain nitrate can be fed to cattle if the feeds are managed properly. Feed testing is essential in determining what forages are safe and how to mix different forages and grains to provide a safe ration. The costs of feed testing are considerably less than the loss of a single animal.

Ruminants have different capacities to convert nitrate into nitrite and finally to ammonia. Cattle have the lowest capability and therefore are at greatest risk. The ability of individual animals to tolerate nitrates in feed is variable, which complicates the determination of a safe level of nitrate in a feed. An animal in good body condition, receiving a diet that meets daily nutrient requirements, is able to convert nitrate to nitrite and finally to ammonia more efficiently than an animal that is inadequately fed or in poor condition. Animals in poor condition, even if well fed, have more trouble converting nitrite to ammonia.

It is the rumen microbes, not the animal, that adjust to high nitrate feeds. Rumen microbes are responsible for the conversion of nitrate to nitrite and then to ammonia. The microbes are able to adapt to a constant level of nitrate in the feed and make the nitrate conversion cycle more efficient. It takes three to five days for the microbes to adjust to the new rumen conditions. Once adjusted, the microbes' capacity for conversion increases by three to five times above normal levels. During the adjustment period, some of the microbes die off and the rate of digestion slows down. Once the microbial populations return to normal levels, digestion rates return to normal. Over time, rumen microbes do adjust to the higher nitrate content in the feeds, increase their survivability and are able to function

well in the new environment. This process is why an adapted animal is able to handle higher levels of nitrate in a diet. However, this does not make it easier to determine what nitrate level is safe.

Gradually introducing feeds with higher nitrate levels allows the microbes to adjust somewhat. If animals are abruptly switched from a low nitrate level to a higher level, a buildup of nitrates can be expected before the microbes become adapted. Therefore, rotational grazing or changing winter feeds that contain different nitrate levels may put the animals at risk. It is important to provide a ration that contains a relatively constant amount of nitrate.

Animals that are accustomed or adapted to a ration that contains nitrate can quickly pass this adaptability to animals that are held in close physical proximity (e.g. in the next pen) within two to three days. The mechanism is not known, but it does occur.

The risk of nitrate toxicity can be reduced, but not eliminated, by taking the following steps:

- dilute the nitrate content of the total ration by feeding a combination of low and high nitrate feeds
- feed the ration in two or three meals per day, rather than just one meal per day
- allow cattle to adjust to low levels of nitrate before increasing the nitrate content of the ration
- ensure that livestock are being fed a balanced ration for the level of production that is expected

- wait several days before cutting crops affected by freezing or hail damage to allow the excess nitrates to go back into the soil
  - ensilaging helps reduce nitrate levels by about 40 per cent

The accumulation of nitrate in plants does not necessarily mean that a problem will occur. Knowing how to manage the harvesting and feeding of a feed that contains nitrate reduces the risk of problems. For more information, refer to *Nitrate Poisoning and Feeding Nitrate Feeds to Livestock* (Alberta Agriculture and Food's Agdex FS400/60-1).

### Polioencephalomalacia (Polio)

Polioencephalomalacia (polio) is a non-infectious disease of cattle characterized by reduced feed intake, impaired vision, muscle tremors and lack of co-ordination, head pressing against inanimate objects, grinding of teeth, groaning, convulsions and lying down or leaning. There are two basic forms of the disease: the acute form sporadically seen in feedlot cattle where affected animals are frequently found in a coma, and the mild or subacute form sporadically seen in animals on pasture.

The incidence of the disease in Alberta is rather low (1.7 to 6.6 per cent annually). In about 50 per cent of the affected animals, death can occur within a few days of the start of the disease. The death rate can be as high as 90 per cent in acute cases and about 50 per cent in subacute cases. Animals with the subacute form may recover completely or may never be completely better as their average daily gain may be lower than unaffected animals.

The causes of this serious nervous disease in cattle remain inconclusive, but could result from long-term thiamine deficiencies in the rumen and other tissues due to an interplay of several factors. The following are some of the factors and conditions that may predispose your cattle to a thiamine deficiency and subsequently to polio:

- Thiamine may be destroyed through an increase in the amount of thiaminase, an enzyme in the rumen. There are two types

of this enzyme: thiaminase type I and type II. These exoenzymes (bound to the cell surface of certain types of ruminal bacteria) destroy thiamine in the rumen. An increase in the amount of thiaminase may occur when:

- The diet is abruptly changed to concentrates. This change may cause the amount of thiamine to fall rapidly. The decrease is usually associated with an increase in certain types of ruminal bacteria with thiaminase type I activity. Apparently, the sudden decrease in rumen pH (increase in rumen acidity) releases the enzyme. Therefore, acidosis (grain overload) has been linked to polio.

Certain species of fungi from mouldy feed produce high amounts of thiaminase and can lead to increased destruction of thiamine in the rumen.

- Thiamine in the rumen may be destroyed by amprolium (a coccidiostat), which acts as an anti-thiamine substance (anti-metabolite) and may accentuate the destruction of thiamine in the rumen.
- A cobalt-deficient diet may also lead to a thiamine deficiency, although the evidence for this is unclear.
- Excessive sulphur intake, as a consequence of high amounts in the feed and/or the drinking water of cattle, can lead to the destruction of thiamine in the rumen.

Prevention is difficult. It is prudent to supplement diets of concentrate-fed cattle as a method of preventing and controlling the disease. Increasing the roughage content of feedlot rations and supplementing the ration with thiamine at 1 g (1/28 oz.)/head/day for about two to three weeks may reduce the incidence of the disease. Research is needed to establish protective levels necessary to control polio in feedlot cattle.

Occasionally, polio occurs in pastured cattle. If this happens, removing the cattle from the problem pasture or adding extra thiamine to the trace minerals may work.



Call a veterinarian any time animals show nervous signs. Making a definitive diagnosis is difficult because nervous diseases look alike. The veterinarian should perform a complete autopsy for any death caused by a nervous condition. Often a lab needs to look at brain tissue in order to make a diagnosis. Polio causes the brain to fluoresce under ultraviolet light.

## Grass and Winter Tetany

Hypomagnesemic tetany is also known as grass tetany, grass staggers, winter tetany and lactation tetany. It is a complex metabolic disturbance characterized by low plasma magnesium (<0.65 mmol/L) and a reduction in the concentration of magnesium in the cerebrospinal fluid (<0.5 mmol/L) (Aiello 1998). Grass tetany refers to tetany-like symptoms that occur after animals are turned out on lush pasture. Winter tetany refers to similar symptoms exhibited by animals fed on winter rations. Clinical signs are relatively consistent in all cases, regardless of the cause. Winter tetany is often confused with milk fever, so ask your veterinarian to check the blood sample for calcium and potassium levels, as well as magnesium.

Symptoms of the disease include decreased milk production, reduced weight gain, depressed appetite, slight nervousness and muscle tremors. In acute cases, hyperexcitability, muscular spasms, trembling, lack of co-ordination, staggering and convulsions that eventually lead to death may be observed. Occasionally, affected cows look like those with milk fever in that they are down, very quiet and unable to get up. The condition is often seen in cows in late pregnancy or after calving. Often the first sign of this problem in a beef herd is a dead cow with marks of struggling or paddling on the ground around her head and legs.

Animals treated before they go down respond well to intravenous magnesium and calcium gluconate solutions. Animals treated in the late stages of the disease often fail to make a complete recovery.

If lactating cows are put out on lush pasture, magnesium needs to be included in their minerals at a rate of one to three per cent. Most mineral supplements contain little if any magnesium.

High magnesium levels result in reduced palatability of the mineral supplement. (Refer to the *Potassium* section in the *Nutrition and Feeding Management* chapter for more information.)

## Milk Fever

Low calcium levels in mature cows (five to nine years of age) may result in milk fever just before or after calving. Milk fever occurs as the formation of colostrum draws a high level of calcium from the blood serum. About 2.5 g of calcium are extracted from blood for each kilogram of colostrum produced. Acute milk fever is observed when the serum calcium level falls rapidly from the normal concentration, which lies between 2.2 and 2.6 mmol/L. Either increasing intestinal calcium absorption or increasing bone resorption or both must replace the calcium lost from the blood serum.

There are three discernible stages of milk fever. During stage one, cows are able to stand, but show signs of hypersensitivity and excitability. Cows may have fine tremors over the flank and loins and display ear twitching and head bobbing. Cows may appear restless, shuffling their rear feet and bellowing. If calcium therapy is not started, the cows will progress to stage two.

In stage two, cows are unable to stand, but can maintain sternal recumbency (laying on their front quarters). Other symptoms of this stage are depression, anorexia, dry muscle, subnormal body temperature and cold extremities, and decreased intensity of heart sounds. Smooth muscle paralysis leads to what looks like bloat, failure to defecate and loss of anal sphincter tone. Ability to urinate can also be lost. Cows often tuck their heads into their flanks, or if the head is extended, an S-shaped curve to the neck may be noted.

In stage three, cows lose consciousness progressively to the point of coma. They are unable to maintain sternal recumbency, have complete muscle flaccidity, are unresponsive to stimuli and can suffer severe bloat. The heart rate can approach 120 beats/min and the pulse may be undetectable. Cows in stage three may survive only a few hours.

The incidence of milk fever increases with the age and parity of the cow. It is very rare for milk fever to occur in heifers. A research study done by animal scientists at the University of Saskatchewan in 2002 to 2003 showed that beef cows from several farms affected with 'downer' cow symptoms showed several trends that indicated that diet may contribute to milk fever in beef cows near calving. All of the affected animals were fed a dry cow ration consisting of mainly cereal greenfeed. Cows fed these rations would have been consuming excess amounts of potassium. All diets had a significantly high dietary cation-anion balance (DCAB), partially due to the high potassium level. Most of the cows had low serum calcium, low phosphorus, or both, likely due to a combination of dietary and metabolic factors. Treatment of the affected cows required larger than normal doses of calcium/magnesium/phosphorus solutions. The researchers concluded that the potassium contributed to an increased DCAB in the dry cow ration.

There is a limited amount of published information about the significance of high DCAB values for beef cattle. Extensive research has been conducted in dairy cattle and recommendations for optimum dietary DCAB have been published. Dairy producers now use the dietary cation-anion difference to prevent milk fever by feeding a DCAB diet for one week before calving at a cost of about \$5 per day. However, in beef cattle operations the exact calving date is usually not known and the individual animals are not fed separately to the rest of the herd. There are no formal recommendations as to an appropriate DCAB level for the diet of beef cattle.

Another option that may help reduce the incidence of milk fever is to feed a ration that is low in potassium and high in calcium to the beef cow herd for about 45 days before the start of the calving season. (For more information on milk fever, refer to the *Calcium* and *Potassium* sections in the *Nutrition and Feeding Management* chapter.)

## Hardware Disease

Nails or other metallic objects swallowed by cattle may puncture the wall of the reticulum (second stomach). Acutely affected animals go off feed suddenly, move slowly and have pain in the area of the sternum. They are reluctant to urinate

or defecate and their feces are usually drier than normal. Chronic cases of hardware disease are hard to diagnose as the animal is usually just a little off. There may be chronic bloat if the vagus nerve is involved. The reticulum is close to the heart, so heart failure may be the end result. Hardware disease was often confused with Johne's disease as both result in diarrhea and weight loss in the later stages.

Treatment of acute hardware disease includes antibiotic therapy and anti-inflammatory drugs. Often a magnet is given in the hopes of preventing further migration of the metal. If a magnet is placed in a cow, it settles in the reticulum for the life of the animal. Metal is constantly attracted to the magnet and then digested by the stomach acids. It is important to choose strong magnets if you are going to the effort of putting them in. For extremely valuable animals, surgery may be performed to remove the foreign object.

Other preventive measures include installing magnets in milling equipment and cleaning up pastures, paddocks and hay fields. With the use of modern equipment more possibilities to ingest metal exist. As an example, silage cutters can make nice bite-sized pieces out of barbed wire. Check and clean the magnets on equipment frequently. You are likely to find nails, staples, wire and grease nipples.

## Sweet Clover Poisoning

Feeding mouldy sweet clover hay or silage that contains dicumarol causes sweet clover poisoning. Coumarin is contained in sweet clover and when it is metabolized by various moulds, dicumarol is produced. Dicumarol inhibits vitamin K absorption and induces a vitamin K deficiency. Vitamin K deficiency prevents normal blood clotting, causing susceptibility to haemorrhaging. Thus sweet clover poisoning is characterized by a susceptibility to hemorrhaging.

Not all mouldy sweet clover is toxic, and just because no mould is present or visible does not mean that the sweet clover is not toxic. Poisoning occurs less frequently in silage than in hay, and rarely occurs in animals on pasture. Dicumarol levels above 10 ppm in sweet clover hay are suggestive of possible toxicity problems.

Cattle that suffer from sweet clover poisoning usually behave normally until the problem becomes severe. The main sign of sweet clover poisoning is hemorrhaging, either external or internal. Internal hemorrhaging results in obvious subcutaneous (under the skin) swellings caused by pools of blood. Under severe conditions, animals are very weak, stiff and reluctant to move because of hemorrhaging in joints and muscles. The mucous membranes are pale. The animal becomes progressively weaker and dies without a struggle. Animals fed mouldy sweet clover hay can have a prolonged blood-clotting time before internal hemorrhaging occurs. Minor surgery, such as castration or dehorning, may lead to profuse hemorrhaging and death.

It is important to consult with your veterinarian immediately if animals show signs of poisoning. Animals that show signs of sweet clover poisoning can sometimes be saved by a direct blood transfusion. Intramuscular administration of vitamin K can also be done. It is also important to remove all animals from the sweet clover and place them on high quality alfalfa that is high in vitamin K and calcium.

Other preventive measures include:

- Grow sweet clover varieties that are low in coumarin. Make sure the hay is thoroughly dry. This can take more than 14 days because of the coarse stem and high moisture concentration of sweet clover. An alternative to lengthy curing is to silage the sweet clover, decreasing the chances of mould and toxicity.
- Ammoniation of stored sweet clover hay using anhydrous ammonia reduces dicumarol concentrations by inhibiting mould growth.
- Feed sweet clover hay or silage for only two weeks at a time, then feed another type of forage for two weeks, then feed sweet clover for another two weeks (two weeks on, two weeks off program). This helps to neutralize the toxicity. Intermittent feeding is safer than mixing good hay and mouldy hay together.
- Do not feed sweet clover for three weeks prior to calving, or before any surgical procedures like dehorning and castration.

- Supplement rations with vitamin K to help neutralize toxicity.
- Supplement rations with calcium to help prevent hemorrhaging.

## Vagus Indigestion

This condition is difficult to diagnose. It is caused by damage or irritation to the vagus nerve, the nerve that makes the rumen move. This problem is often the result of hardware disease as the nerve runs close to where the metal penetrates the reticulum. Affected animals are poor doers, eat poorly if at all and may appear full on the left side of the abdomen, as if they are bloated.

Treatment is the same as for hardware disease, but shipping for slaughter is often the best option.

## Impaction

Impaction occurs when poor quality feed moves through to the abomasum (fourth stomach) before it is properly digested by the rumen micro-organisms. It becomes impacted in the abomasum.

The signs of impaction develop slowly, over a couple of weeks. They are often not noticed until one or two animals become weak and go down. An affected animal initially becomes sluggish and goes off feed. As the abomasum becomes more impacted, water is prevented from passing through the large intestine and the animal becomes dehydrated and produces firm, scant manure. Sometimes a weak, staggering gait is noticeable before the cow goes down. The problems are made worse if the cow is heavily pregnant as her energy demands are greater and the fetus takes up more room in the abdomen, reducing the physical gut capacity. Cows carrying twins or those low in the pecking order are more likely to be affected if limit feeding is used.

Wintering cows that are fed large amounts of poor quality ground or hammered roughage (e.g. straw) are susceptible to impaction. Frequently the grain or energy intake is low. Impaction occurs in cold weather or during late gestation when an animal's nutritional requirement increases, the consumption of feed increases, but the animal's ability to digest is poor. The cows keep eating in

order to keep warm in winter. They look big and full, but upon close examination they are generally quite thin, with their ribs showing.

Treat the first case of impaction as the tip of the iceberg. Examine the rest of the herd closely as other animals may soon develop the condition. Because treatment is futile in advanced cases, slaughter is recommended. Laxatives and mineral oil may help cattle in the early stages of the condition. Calcium may also help to get the rumen micro-organisms to properly digest food. Herds showing early signs of impaction and/or individual cows with impaction should have free access to fresh water through the recovery period. Good nursing care and shelter are required to help recovery.

Preventive measures include ensuring that the energy and protein content of the ration is adequate in cold, wet or windy conditions, and in the last trimester of pregnancy. Supplementing the ration (especially poor or low quality roughage rations) with grain is advised, especially for first-calf heifers and thin cows. Avoid finely chopped poor or low quality roughages.

## Reproductive Problems and Diseases

### Bovine Virus Diarrhea (BVD)

Bovine virus diarrhea (BVD) is a viral disease in cattle. Several syndromes involving BVD have been identified. There is a respiratory form that is often associated with mycoplasma pneumonias. There is also the abortion, fetal mummification, congenital defect syndrome, with defects involving the brain or eyes. The thrombocytopenic (anemic) hemorrhagic form is caused by type 2 BVD.

Bovine virus diarrhea spreads through the herd by contact with infected animals and the ingestion of feed contaminated by manure or urine from infected animals. It is widespread in most cattle herds, appearing on a farm and then disappearing in subsequent years. The disease is usually subclinical, meaning clinical signs are not observed, but occasionally a severe fatal diarrhea affects young animals between six and 24 months of age.

Whether or not an animal dies of the fatal form of BVD depends on whether the animal was exposed to a mild form of the virus before birth. A fetus exposed to the mild form of the virus 120 days or more before gestation, may become a carrier of the mild form and show no signs of the disease. If an animal between six and 24 months of age is exposed to the virus for a second time, through vaccination with the live form of the virus, a fatal, untreatable diarrhea usually develops.

The severe form of BVD is seen as a persistent, watery diarrhea associated with sores in the mouth. Often there is also inflammation of the eyes. Occasionally, affected animals become lame as a result of sores on their feet near the coronary band (tissue band just above the hoof). Survivors of this form of BVD are rare and usually unthrifty.

Infections caught during pregnancy may result in abortions, stillbirths, mummified fetuses, birth defects or normal calves that are carriers of the virus. The severity of the problem depends on the stage of the pregnancy when infection occurs.

Control is directed towards vaccination of all female breeding animals in an attempt to prevent infection of the developing fetus. Two types of vaccines are available: a modified-live vaccine (MLV) and a killed vaccine. The killed vaccine is safe to use on pregnant animals, but the modified-live vaccine can only be used on open animals that are kept completely separate from pregnant animals. A veterinarian should be consulted regarding precautions in using these vaccines.

### Abortions

Abortions can be one of the greatest losses to the cow-calf producer during the early winter months. The average abortion rate in Alberta is two to three per cent. Most often, abortions are seen from November to January, when cattle are most easily observed. Others occur throughout the gestation period, but are harder to observe.

As previously discussed, vaccinations can prevent the two main causes of abortions, IBR and BVD. Abortions also stem from problems with the environment, as well as maternal causes. By pregnancy checking cows in the fall and determining if the open rate is high, abortions or other reproductive problems can be investigated.



Any fetus (if found) and placenta (if still available) should be submitted to a veterinarian for testing, especially if the abortion rate has crept above three per cent or several abortions are observed in close proximity. Make sure the submitted tissues contain the placenta and the cotyledons (buttons on the placenta). Submitting the placenta with the cotyledons attached doubles the success rate of diagnosis. It is important to submit a clean piece of placenta from inside the cow. Severe genetic abnormalities result in abortions, but most aborted fetuses do not reveal any gross abnormalities. Therefore, further diagnostic testing is necessary. However, even with proper submissions, only 50 per cent of abortions are positively diagnosed. Depending on the diagnosis, your veterinarian may recommend changes to your management practices to minimize problems in coming years.

Fungal problems can be responsible for outbreaks of abortions. Fungal abortions occur from four months to calving and usually occur more often in winter. It is believed the fungi gain entry in feed, through the mouth and the respiratory tract (trachea and lungs) and travel through the blood to the placenta. For control, mouldy feed should be avoided. Mouldy feed can be given only to non-pregnant animals.

Recently, the protozoan *Neospora caninum* (a microscopic parasite) has been identified as a cause of reproductive loss in beef herds. In the past, this parasite was primarily seen in dairy cattle. It commonly causes abortion at four to six months, or causes fetal mummification that is similar to some BVD abortions. The parasite must cycle through a definitive (final or end) host where it replicates. Dogs have been identified as one definitive host for this parasite. Other canines, such as coyotes or foxes, may also serve as hosts. Cows are intermediate hosts. They ingest the oocysts from dog feces. Feed sources contaminated with dog feces are a common method of transmission. Once established, the organism crosses the placental barrier and infects the fetus. Diagnosis relies on blood testing of aborted cows, as many of the fetuses that are aborted early in gestation are not found.

Additional references to abortion are included in the information on specific diseases in this chapter. Producers should discuss all the

reproductive diseases with their veterinarian before making vaccination decisions as conditions and recommendations vary from region to region.

### **Vibriosis (*Campylobacteriosis* (C.))**

The organism *Campylobacter fetus venerealis* or *C. fetus fetus* causes a venereal disease in cattle that is characterized by early embryonic death, infertility, a protracted calving season and occasionally abortion. It is transmitted by the reproductive organs of cattle during breeding.

The symptoms in cows usually include prolonged heat cycles and a drop in the conception rate. Conception problems can last from two to six months, or longer. The problems last until the cows develop immunity. Abortions are observed occasionally.

The diagnosis is not easy to make and is based on herd history or isolating the organism from an aborted fetus. One reason it is hard to prove the existence of the organism is that it is very fragile.

In the past, bulls were thought to be permanent carriers of the disease. However, recent evidence indicates that a young bull can spread the infection from an infected cow to a non-infected cow, even when he is not infected. The infection will clear up on its own in young bulls that are rested from breeding. Older bulls develop a carrier state that can be treated, but they are very susceptible to becoming re-infected.

To prevent vibriosis, administer the first vaccination to the cows about 40 days before the breeding season starts, followed by a booster vaccination 10 days before the breeding season starts. The vaccines are very effective when used on breeding females, but immunity after vaccination is short-lived. This is why females must be vaccinated just prior to the breeding season. Artificial insemination is another method of preventing the disease as semen is only drawn from bulls known to be negative for vibriosis.

Fortunately, this disease is not common. Veterinarians often recommend vaccinating where large groups of cattle are gathered for breeding, such as at community pastures.

## Trichomoniasis

Trichomoniasis is a contagious venereal disease that causes infertility, abortion or pyometria (a pus-filled uterus). It is a true venereal disease because transmission occurs only through sexual contact. The disease is caused by a flagellated protozoan (a micro-organism with a whip-like tail) that lives in the reproductive tract of cows or the sheath area of bulls.

Bulls are carriers and show no symptoms. They spread the organism during breeding. Bulls often remain permanent carriers. The trichomoniasis organism grows best where there is no air and thrives in little pockets or crypts that line the sheath. Older bulls have a higher infection rate as they have more of the crypts. Older bulls can start infecting cows at the beginning of the breeding season and can greatly increase the chance of exposing a large number of cows to the disease.

Recently infected cows develop a mild, white, sticky discharge from the vulva, which can last for up to two months. Often the cow conceives normally, but reabsorb the fetus at approximately 60 days gestation. A large number of cows will be affected in herds that have not encountered the disease before. Repeat breeding or infertility of individual cows can last up to five months. Again, the reason for repeat breeding appears to be death of the embryo. Eventually, cows begin to cycle again and can carry a fetus to term. Cows develop immunity and conceive later, if the breeding season is extended. A prolonged calving interval results.

Testing involves culturing the sheath of suspect bulls. One test is about 80 per cent specific. It takes three tests at weekly intervals to ensure 100 per cent accuracy. The bulls also need to be rested for two weeks prior to the test. An ideal time to test is when a breeding soundness exam is being performed. The culture can be taken while the bull is still restrained.

Preventive measures include:

- purchasing only virgin bulls
- keeping the bull battery young, as bulls that are over five years of age are more likely to harbour the organism

- never using rental bulls or bulls with unknown backgrounds
- keeping bulls separate from cows, except during the breeding season
- pregnancy testing all cows and heifers 60 to 180 days after breeding and cull all open cows and heifers
- not lending bulls or exposing them to cows of unknown origin
- raising your own replacement animals
- buying cow-calf pairs or pregnancy-tested cows, as it is extremely rare for pregnant cows to carry the disease
- keeping fences in good repair to avoid getting the disease from a neighbour's cattle
- checking bulls for the disease during the breeding soundness exam if pregnancy rates are low
  - test bulls especially those more than four years of age
  - test all new bulls before placing them with cows
- not purchasing and mixing cattle from many sources as this poses the greatest risk for spreading trichomoniasis and many other contagious diseases
- buying open cows for feeding, not breeding
- an effective vaccine has been developed, but is restricted to use in endemic areas
  - in severe cases, the vaccine can improve the pregnancy rate by 10 to 15 per cent

## Retained Placentas

Fetal membranes that are retained for more than 24 hours are a common occurrence in the cattle industry. The method of treatment has changed a lot over the years. In the 1960s and 1970s, many veterinarians spent a great deal of their time cleaning cows. This process has since proven to be harmful, as cleaned cows take longer to rebreed than those that are left alone.

The incidence of retained placentas is influenced by the nutritional status of the herd. Both overly thin (body condition score of 1 to 2) cows and overly fat (body condition score of 5) cows have a higher incidence of this problem. (For more information on body condition scoring see the *Body Condition and Reproduction* section of the *Herd Management* chapter.)

Nutritional shortages of vitamins A and E or the mineral selenium may contribute to a higher percentage of retained placentas. Discuss this with your veterinarian or nutritionist to determine the levels required in your area.

Any prolonged labour, hard pulls or extended intervention during calving drives up the incidence of retained placentas. Cows that abort commonly have retained placentas as immaturity prevents the cotyledons from being released. Twin pregnancies often cause retention for the same reason, as the average gestation for twins is one to two weeks shorter.

If a cow has a retained placenta, a fever and is off feed, antibiotics should be given (e.g. long-acting tetracycline). More commonly, the cow looks perfectly healthy despite having a very smelly membrane hanging out. Treating the uterus internally has been found to be detrimental because the membranes are retained longer. If there is evidence of discharge three to four weeks after calving, a veterinarian may recommend injecting prostaglandin to induce heat because cycling is a cleansing process.

Preventive measures to reduce the incidence of retained placentas include:

- ensuring that the cows have a condition score at calving of 2.5 to 3.5
- providing adequate nutrition, including trace minerals and vitamins (especially vitamins A and E, and selenium)
- following dystocia or the birth of twins, at the discretion of a veterinarian, oxytocin may be given to cause the uterus to contract
- keeping hands and equipment clean if you do need to intervene in a birth



*Preparing to replace uterine prolapse.*

- investigating all abortions
- vaccinating for all infectious causes of abortions in your area

## Prolapsed Uterus

This refers to the entire uterus (calf bed) being pushed inside out after the delivery of a calf. It commonly occurs within minutes or seconds of calving and is a veterinary emergency. The entire uterus is the size of a 20 L (5 gal.) pail and is identifiable by the red buttons or cotyledons present on it. Prolapsing can also occur several days after delivery, often as a result of straining from a retained placenta. This is most commonly seen in first-calf heifers because of dystocia (calving difficulty), but it is also seen in older, multiparous (experienced) cows.

Unlike a prolapsed vagina, this is not a hereditary condition. The odds of this cow prolapsing again are no greater than any other cow in the herd. Therefore,



it is recommended that once a cow has been treated successfully for a prolapsed uterus and rebred, she should be retained in the herd.

It is important to verify this problem as quickly as possible and call your veterinarian immediately. If the cow is kept quiet and can be restrained (caught in a maternity pen), treatment success is high. Keeping the cow quiet is key because it prevents the rupture of the large blood vessels that feed the uterus from inside. If the uterus is allowed to bounce around it can rupture, leading to death by internal bleeding. If the uterus can be returned undamaged and fairly clean, the cow's chance of rebreeding is good to excellent.

The veterinarian gives an epidural anaesthetic and replace the uterus (preferably without the placenta attached). Antibiotics are generally given systemically and intrauterine. Sutures are usually placed around the vulva to prevent reoccurrence. In most cases the uterus has contracted down enough in one week to allow the removal of the sutures.

A cow that has cast itself in a downhill position and is unable to get up, may prolapse. Cows that get up directly after calving have gravity working for them, and mothering the calf stimulates the release of oxytocin. Oxytocin is a natural hormone causing milk letdown and uterine contraction.

## Prolapsed Vagina

Prolapsed vagina is a condition in cows where the hind part of the genital passage protrudes from the body, usually two to three weeks before calving. The exposed vagina becomes dirty and sore, causing the cow to strain and make the condition worse. Further straining can result in the rectum being pushed out as well.

Prolapsed vagina usually worsens over time. It starts as a little red ball that only protrudes through the vulva when the cow is lying down. Such animals should be culled in the fall because the condition is likely to recur annually. There is a hereditary/genetic susceptibility to this condition. As a result, female offspring may be culled.

Treatment involves having the veterinarian freeze the tail head, then clean and replace the prolapse. Several techniques are used depending on the severity of straining. A couple of procedures

allow calving to occur without intervention. However, in most cases these cows must be watched closely near calving so the sutures can be removed to prevent tearing the vulva during delivery.

Generally, a cow will not prolapse again until the next year, unless breeding irritation or retained placentas also result in prolapses. When purchasing individual pregnant cows, make sure they are not sutured from prior prolapses. If they are, you may be buying more than you bargained for.

## Prolapsed Rectum

Prolapsed rectums are usually a sporadic occurrence. Finding them early is critical as they swell and harden rapidly. Coccidiosis can cause this condition in young calves. Older bull calves can prolapse from riding aggressively. The crushing of implants can lead to bullers (steers that act like bulls) with prolapses as a symptom. Constipation, if severe enough, can cause prolapsing from increased straining.

Bad vaginal prolapses can sometimes result in the rectums also being pushed out. The treatment is the same as for vaginal prolapses. There are no known hereditary components to prolapsed rectums and keeping the animal is acceptable as long as scarring does not restrict the rectal orifice.

## Cancers

### Cancer Eye

Cancer eye (*squamous cell carcinoma*) is the most common cancer in cattle. It occurs on or around the eye and involves either the eyeball, eyelids or third eyelid. This condition is more prevalent on white-faced cattle because of the ultraviolet irritation. Initially it resembles pinkeye, but there is little to no sign of pain (e.g. squinting) in the early stages.

If diagnosed early, several treatment options are available including: cryosurgery (using liquid nitrogen), heat therapy or surgical removal. If detected early and if only the third eyelid is affected, it can be surgically removed and the eye can be saved. If the eye (entire mass) is successfully removed, a cow can be maintained for several years. As with blind cows, producers need to be





Cancer eye

careful handling one-eyed cows. Producers should watch for relapses of the cancer.

The shipment of cattle with cancer eye has become an animal welfare issue and the condemnation rate is high. Cattle with advanced stages of cancer eye should be operated on or put down. Surgical removal is the most economical option. Some cancer eyes are removed to ensure passing the slaughter inspection.

## Enzootic Bovine Leukosis

This is the second most common type of cancer in cattle, but in this case the cause is viral in nature. This disease is commonly referred to as leukemia or *bovine lymphosarcoma*. Four types of lymphosarcoma are documented, but only the adult form is of viral origin. The other forms of lymphosarcoma are rare. The virus is spread through blood transfer. It can be transmitted through biting insects, shared needles used for injections or possibly even vigorous rectal palpating. Other management procedures such as dehorning, tagging or tattooing also have the potential for spreading this disease.

Dairy cattle are more susceptible because of their close proximity to one another. Less than five per cent of infected cattle actually develop tumours and die of the disease. The clinical signs develop over a period of years and vary depending on where the tumour develops. Weight loss is common. The tumour can develop behind the eyes, which causes them to bulge out.

There is no treatment for this disease and confirmation is often made through an autopsy. Blood tests can be conducted on herdsmates. This is a mandatory test for purebred animals that are being exported to other countries. Positive animals can be shipped or managed to prevent spread of the disease to herdsmates.

Producers can control the spread of this disease by taking a few precautionary steps. Ensure that you have adequate control over biting insects. Clean and disinfect nose leads, ear taggers, dehorners and other equipment that comes in contact with blood. Change needles frequently, after at least every 10 to 15 head, when vaccinating. If you have a known positive animal, treat it last when vaccinating. Culling a positive animal may also be in order to minimize spread. Dairy animals, especially those used in embryo transplant programs or as recipient mothers on beef farms, should be tested prior to acceptance.

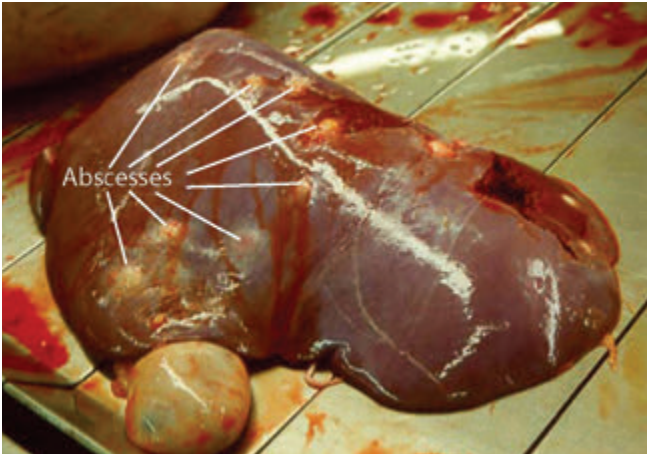
Your veterinarian will test any cows suspected of having the disease. If a positive animal is found, it may be necessary to monitor and test the herd.

## Abscesses

### Liver Abscesses

Liver abscesses (Figure 57) occur in all ages and breeds of cattle, wherever cattle are raised. They are most common in feedlot and dairy cattle fed high-grain rations or in cattle after the accidental consumption of toxic levels of grain.

Grain overload is associated with several digestive disorders and may result in clinical and subclinical acidosis, liver abscesses or bloat. These disturbances arise from the ingestion of large amounts of highly fermentable cereal grain, which fosters proliferation of acid-tolerant bacteria and production of excessive quantities of acid and bacterial slime in the rumen. The excessive production of acid can damage the rumen wall (rumenitis, sloughing of the rumen wall) and reduce feed intake. The acid condition can produce lesions in the rumen and allow bacteria to enter the bloodstream and form abscesses in the liver. Feedlot cattle have the highest incidence of liver abscesses.



**FIGURE 57.** Liver abscesses

No clinical signs are noticeable unless the abscesses are massive or spread to other organs in the body, such as the lungs. Grunting and other signs of pain may occur with movement or when the animal lies down. However, feed conversion is reduced for feedlot steers with multiple liver abscesses, and affected livers are condemned at slaughter.

Adequate forage in the diet, optimal processing of cereal grain, timely adaptation to diets, various dietary additives and proper bunk management are the keys to prevention of grain overload in feedlot cattle. (For more information, refer to the *Grain Overload* section in this chapter.)

Avoid sudden changes of diet, especially from a forage-based ration to a high-grain (carbohydrate) ration. Bacterial populations that digest cereal grain differ from those that digest forage. The populations require time (14 to 21 days) to adjust as the diet is changed. One of the easiest ways to achieve this transition is to introduce cattle to a mixed as-fed diet consisting of 30 to 40 per cent cereal grain and 60 to 70 per cent forage upon entrance into the feedlot. Maintain the cattle on this diet for seven to 10 days, and if no digestive disturbances are noted, decrease roughage by 10 per cent every two to four days until the diet contains 10 to 20 per cent forage. Most finishing feedlots already minimize sudden changes to their ration.

Providing feedlot cattle with a product called Tylan® (tylosin) has proven to be effective in achieving a 50 to 60 per cent reduction in liver abscesses in addition to improving weight gains. Ionophores have little or no effect on the incidence of liver abscesses.

Producers can gain valuable information at slaughter as livers can be evaluated and scored. Given the results, producers can tell how well their cattle are adjusting to their feeding program. A higher than average incidence of liver abscesses at slaughter may also be indicative of grain overload. If multiple animals have more than one liver abscess, producers should be checking with their veterinarian.

### External Abscesses

At some point producers are likely to see large areas of swelling develop over just about any part of an animal's body. These abscesses are commonly the result of contaminated needles being used when injecting, injuries or abrasions, or an old navel infection if the abscess occurs on the belly. Cattle with poor immune systems are most likely to develop abscesses. Multiple abscesses may be the result of a systemic disease that is spreading down the lymphatic chain. A veterinarian may need to explore the underlying cause.

Most abscesses, if encased by the body in a thick membrane, do not cause many problems until they get very large. The first thing a veterinarian will do to deal with an area of swelling is to aspirate it or suck the contents into a syringe. This is done to ensure that there is pus in the swollen area and not blood or gut contents. The presence of blood, clear fluid or gut contents signal other conditions. If the abscess is ready, it is then lanced at a place that allows good drainage and minimizes the risk of recurrence. If an abscess occurs over a vital structure, such as the jugular vein, one must know anatomy well before attempting this. The incision is then flushed and in some cases packed with antiseptic-soaked gauze, which is removed a few days later.

A preventive measure is to always change needles after approximately every 10 to 15 animals when vaccinating.

## Toxins

### Ammonia and Urea Poisoning

Urea and many ammonia derivations are substitutes for natural protein in ruminant feeds. If not used properly, they can also be lethal poisons. Urea is recommended in ruminant rations at a rate of no more than three per cent of the grain ration or about one per cent of the total ration. Too much urea in the feed leads to diarrhea and bloating as early symptoms. Frequent urination and defecation are also signs.

Ruminants suffering from malnutrition or disease, or those not used to having urea in their feed, do not tolerate urea well.

Accidental poisoning with urea fertilizer (46-0-0) has occurred from ingestion. Because the product tastes salty, cattle will ingest it. Do not use urea fertilizer to thaw areas around watering bowls. Several handfuls of urea are toxic to a full-grown cow.

### Organophosphate and Carbamate Poisoning

Organophosphates and carbamates are insecticides that are used in many products. Some are applied to the backs of cattle to kill grubs and are quite safe when used in accordance with the manufacturer's instructions. It is critical with all products to know the weight of the animals (especially the young calves) and adjust the dosage accordingly.

These insecticides are also widely used for a variety of purposes in agriculture and can either contaminate cattle feed or be eaten by cattle if not stored safely. When absorbed or ingested in toxic quantities, these insecticides act on the nervous system in various ways. Most new insecticides have lower toxicity, usually requiring five to 10 times the dosage to be toxic.

The symptoms of organophosphate or carbamate poisoning include initial excitement, difficulty in breathing, profuse salivation, sweating, tears, urination, bluish gums, colic and sometimes diarrhea, muscular twitching, staggering, paralysis, depression and death.

Your veterinarian may use the antidote atropine if the poisoning is detected early enough.

## Reportable Diseases

Reportable diseases are defined by the federal *Health of Animals Act* and are listed in the Reportable Disease Regulations under section 2 of this act. The *Health of Animals Act* requires that anyone caring for or having control over animals, immediately notify a veterinary inspector of the Canadian Food Inspection Agency (CFIA) when the person suspects one of the diseases or when the person becomes aware of any fact indicating the disease's presence. The purpose of the *Health of Animals Act* is to prevent the introduction of animal diseases into Canada and to control or eliminate diseases that either affect human health or could have a significant economic effect on the Canadian livestock industry.

### Anthrax

Anthrax instills fear into many producers, and with good reason. It is a reportable disease, meaning it must be reported to the CFIA. Cattle, along with many other species including man, are susceptible.

A spore-producing bacterium causes this disease. The spores can remain infective in the soil for more than 50 years. Outbreaks occur in hot, dry summers that have followed a wet spring. Approximately 20 outbreaks were reported in Canada between 1966 and 2001. Thus, the incidence of anthrax is rare.

Sudden death caused by a toxemia is usually the initial sign of anthrax. There is little rigour to the carcass and the blood does not clot. Any sudden death should be autopsied by a veterinarian. If anthrax is suspected, further lab tests are necessary to confirm the cause of death.

If a diagnosis of anthrax is made, federal veterinarians are called in. They help with the quarantine procedures and proper disposal of dead carcasses. Compensation, to a maximum of \$500 per animal, is given for disposal as long as the diagnosis is substantiated. The federal government veterinarians also vaccinate the herd for two years following the outbreak. After the two years, it is the choice of the producer and herd veterinarian as to whether to continue vaccinating.



The preventive vaccine is a nonencapsulated spore vaccine. It offers almost 100 per cent protection after two weeks and is comparable in price to other vaccines. The vaccine is administered subcutaneously and must be given to all ages of cattle by a licensed veterinarian. Since anthrax is relatively rare, veterinarians don't routinely recommend the vaccine as part of the regular vaccination protocol. Most veterinarians only recommend it if your farm or a neighbouring farm has contracted anthrax. It may also be advisable to vaccinate if farms share the same waterway with an infected farm.

### Foot and Mouth Disease (FMD)

Foot and mouth disease (FMD) is one of the most contagious conditions known, with an incubation period of three to six days. This reportable disease affects all cloven-hoofed animals. It is a viral (*picorna*) disease that affects the inside of the mouth, as well as the skin on the teats and feet. Cattle slobber from the sore mouth and are lame. If you detect any symptoms similar to these, call your veterinarian immediately as it is important to distinguish between FMD and similar, less devastating diseases as soon as possible.

Morbidity (the number of animals that contract the disease) approaches 100 per cent. While adult animals rarely die from the disease, they stop eating and become very ill.

In Canada, FMD was last seen in Saskatchewan in 1952. The devastation the disease causes was quite evident during the outbreak in Britain and neighbouring countries in the spring of 2001.

The disease spreads mainly through direct contact. The virus can also spread mechanically on people's clothing, and it can last for months in processed meat and dairy products. If foot and mouth disease were introduced to Canada, it would probably be the result of one of these methods. The federal government prevents meat and by-products from infected countries from entering Canada. Monitoring occurs at points of entry.

A vaccine is available for each of the seven different serotypes of foot and mouth disease, but eradication must be done to maintain export markets. Although vaccinating protects the cattle,

vaccinated animals develop titres (a measurable response in their blood). This response is indistinguishable from exposure to the real disease and makes eradication very difficult. Therefore, vaccinating is not even considered when exporting cattle beef is the final goal.

If this disease were diagnosed in Canada, export markets would close immediately, and whole regions of the country would become quarantined until the disease was eradicated. The Canadian Cattle Identification Program (tagging program) makes it easier for reportable diseases to be traced back to their origin.

Every producer must be vigilant and practice on-farm biosecurity (see the *Biosecurity* section below for more information). This helps prevent foot and mouth disease and many other diseases from entering or spreading on your farm.

### Bovine Spongiform Encephalopathy (BSE) (Mad Cow Disease)

*Bovine spongiform encephalopathy* (BSE), or "mad cow disease," is a progressive, fatal disease of the nervous system of cattle. BSE causes large sponge-like holes in the brain.

BSE is a relatively new disease of cattle. It was first recognized and defined in the United Kingdom in 1986. BSE is one member of a family of diseases called transmissible spongiform encephalopathies (TSE). Other TSEs include scrapie in sheep, chronic wasting disease in deer and elk, and Creutzfeldt - Jakob disease (CJD) in humans.

Although the exact cause of BSE is unknown, it is associated with the presence of an abnormal protein called abnormal prion. Normal prion proteins are already present within an animal's body. Cattle can be exposed to abnormal prions through contaminated feed, or more rarely, through infected cows passing them to their calves (less than 10 per cent of known cases). BSE is not transmitted by animal contact.

There is no treatment or vaccine currently available for the disease.

BSE occurs in mature adult cattle of both sexes. It is a neurological disease involving pronounced changes in mental state and abnormalities of



posture, movement and sensation. The clinical disease usually lasts for several weeks and it is characteristically progressive and fatal. Animals with BSE may show a number of different symptoms including:

- nervousness
- apprehensiveness
- aggressive behaviour directed at other cattle or humans
- abnormal posture
- head shyness, with head held low
- high stepping gait, particularly hind legs
- lack of co-ordination
- difficulty in rising from a lying position
- skin tremors
- reluctance to turn corners, or enter gates or pens
- decreased milk production
- loss of condition or weight loss despite an increased appetite

These symptoms may last for a period of two to six months before the animal dies. Stress appears to cause the more rapid development of clinical signs in some animals, particularly when brought in before calving or if transported. For more information, visit the United Kingdom website on BSE at <http://www.defra.gov.uk/animalh/bse/science-research/bse.html>

BSE has a long incubation period, about four to five years on average, between an animal's exposure to the disease and the onset of clinical symptoms. Most cattle are slaughtered for human consumption between 18 and 22 months of age and are therefore considerably less likely to have developed infective levels of the disease when they enter the food system.

BSE has been a reportable disease in Canada since 1990. The National Surveillance Program was put into place in 1992 to test animals most at risk for BSE. The first case of BSE diagnosed in Canada was found in a beef cow in Alberta in 1993. It had been imported from Britain in 1987. The animal carcass and the herd it came from were destroyed.

Alberta has had a BSE surveillance program in place since 1996. Any suspected case of BSE must be reported to a federal veterinarian. Control and eradication measures are the responsibility of the Canadian Food Inspection Agency (CFIA).

Through Canada's national BSE surveillance program, nine cases of BSE have been found in Canada since 2003 (as of early 2007). The infected animals were condemned at slaughter and no meat from the carcasses entered the food system. The national BSE surveillance program continues to effectively detect periodic BSE cases as Canada progress toward the eradication of the disease. All cases confirmed in Canada have been identified through the program. Since, 2003 more than 117,500 cattle from the highest risk populations have been tested.

The CFIA's feed ban was introduced in 1997 to prevent BSE from entering the food chain. Scientists believe that feeding protein products made from infected cattle or sheep caused the spread of this disease in cattle 20 years ago in Great Britain. Prohibited materials comprise all protein, including meat and bone meal, derived from mammals such as cattle, sheep and other ruminants. Salvaged pet food, plate waste and poultry litter may contain prohibited material and are not approved for feeding to ruminants. Animal proteins exempt from the feed ban that can be fed to ruminants are pure porcine and equine proteins, poultry and fish proteins, milk, blood and gelatin, and non-protein animal products such as rendered animals fats (e.g. beef tallow, lard, poultry fat). For more information, visit the CFIA website (<http://www.inspection.gc.ca/english/animal/feebet/rumin/ruminfse.shtml>).

The CFIA, in December 2004, proposed amendments to the feed ban to strengthen the existing feed controls. The proposed amendments require the removal of specified risk materials (SRM) from all animal feeds, including pet food, and from fertilizer. These tissues are already removed from all animals processed for human consumption. The CFIA inspects feed mills and rendering plants throughout the year on a regular basis. A random selection of farms is also inspected each year. The federal Feeds Act provides the CFIA with the authority to verify that livestock feeds are safe, effective and appropriately labelled.

## MINIMIZING THE RISK OF BSE IN YOUR LIVESTOCK

- Check your feedbags carefully for the label “Do not feed to cattle, sheep, deer or other ruminants.” Such feed contains materials prohibited for ruminants.
  - BE AWARE: It is illegal to feed ruminants prohibited material.
- Store and handle ruminant feed separately from feeds for other animals.
- If you mix feed on your farm, make sure that you do not mix feeds for non-ruminants (such as horses, swine, poultry, etc.) with any feed for ruminants.
- If you have both ruminants and non-ruminants on your farm, or if you mix your own feeds on your farm, keep all invoices for feeds.
- If you notice an animal showing any of the symptoms of BSE, contact your veterinarian, or notify the local CFIA district office, which is listed in the blue government pages of the phone book.

For more information and updates on BSE contact the CFIA's Media Relations office at (613) 228-6682, visit the CFIA's website (<http://www.inspection.gc.ca/english/toce.shtml>) or visit Alberta Agriculture and Food's Ropin' the Web (<http://www.agric.gov.ab.ca/app21/rtw/index.jsp>).

## Brucellosis (Bang's Disease)

Brucellosis is another disease that must be reported to the CFIA. Brucellosis is caused by the *bacterium Brucella abortus*. This same organism can also cause undulant fever in humans.

Susceptible animals can contract brucellosis by eating feed or drinking water contaminated with uterine or vaginal discharges, fetal membranes or fetuses passed from infected animals. The organism persists for long periods if it is protected from direct sunlight. Freezing allows the organism to survive almost indefinitely. The infection is usually brought into the herd by an infected animal. Once an animal has developed the infection, it becomes a permanent carrier.

Clinical signs of brucellosis include late pregnancy stage abortion, retained placentas, infection of the uterus and infertility of the cow. Some animals may also have swollen knees. Bulls develop swollen testicles and become infertile.

Diagnosis of brucellosis is by means of blood serum tests. In the past, all auction markets tested for brucellosis, but the disease was eradicated from cattle in 1985. Since then most testing has ceased, even for export animals to the United States. The federal government still tests at several auction markets in northern Alberta to ensure the disease does not spread from Wood Buffalo Park, where bison are infected with brucellosis. Animals that test positive are slaughtered, as the meat is safe for human consumption. There is a federal compensation program in place through the CFIA.

## Miscellaneous Ailments

### Footrot and Other Common Causes of Lameness

Footrot is a contagious bacterial disease. It occurs all year-round, but more frequently under wet and muddy conditions. Soil-borne bacteria (*Fusobacterium necrophorum*) gain entry to the foot through abrasions caused by sticks or stones. Wet conditions also allow bacteria to more easily penetrate the foot.

An open wound develops between the toes, usually on one foot, and causes the swelling and rotting of these tissues. Hence the term footrot. This results in severe lameness. Many untreated cases progress to deeper tissues of the foot and result in permanent lameness with arthritis. The rotting tissue can shed lots of organisms back into the affected area and the surrounding environment.

Many antibiotics are successful against footrot, if the condition is caught early enough. Usually, an antibiotic's label states if it is effective for treating footrot. Most producers give long-acting products right at pasture. In severe cases, the rotten tissue is removed. This opens the wound to the air, which kills the organism.

Producers can prevent footrot by providing good drainage in feedlots and putting concrete pads around feeders and waterers. On pasture,

prevent cattle from having direct access to dugouts, streams and other bodies of water. This not only keeps the cattle's feet healthier, but protects the riparian areas and water quality. Trim the hooves of any long-toed cattle, especially bulls.

In problem herds, such as those pasturing on muskeg, consideration should be given to using a reliable vaccine that is now available. This may also be used on herd bulls, as it can be extremely costly if your bull comes down with footrot just prior to the breeding season.

Producers should consider culling for bad foot conformation as these cows are often more susceptible to footrot.

Historically, some producers have fed salts fortified with high levels of organic iodine (e.g. EDDI salt) to prevent footrot, but this practice is controversial. Organic iodine has been used at high levels (100 to 400 mg/head/day) to help prevent footrot in cattle. However, recent research indicates that 30 to 50 mg/head/day may be just as effective. The efficacy of treatment levels for the prevention of footrot is still being debated.

Prolonged use of high organic iodine levels may pose significant risks of toxicity in cattle. Signs of toxicity in cattle include elevated temperatures, dry coughing, and runny noses and eyes. Often young calves allowed to consume salt or mineral mixes high in iodine are the first to show signs of toxicity. High dietary levels of iodine result in elevated levels in milk and muscle of treated cattle and are a concern in human health. In Canada, the use of EDDI is now restricted to nutritional levels.

Producers sometimes assume that every lame animal has footrot, but several other conditions can cause lameness, such as sole abscesses, septic arthritis and fescue foot.

Sole abscesses cause severe and sudden lameness that sees the infected foot become almost non-weight bearing. In this case, the abscess needs to be pared out to allow drainage. It usually takes a skilled veterinarian or hoof trimmer to locate this problem. It generally starts as the result of a crack or injury to the outer surface of the hoof, allowing the organism to gain access underneath the sole. Once the abscess is drained and treated, the affected animal usually progresses rapidly.

Septic arthritis is a term given to a long-standing infection that has gained access to the last joint, hidden beneath the foot. This can be the result of long-standing untreated footrot. A clinical sign is a severely swollen toe on the infected side. These cases are often unresponsive to any antibiotic treatment. With cows, surgery can often be done to amputate the infected toe. Recovery is usually quite favourable and the cow can have many years of productive life using the remaining good toe. Bulls are too heavy for this surgery and their breeding ability is greatly diminished. Thus, most are shipped for slaughter. In the case of extremely valuable animals, more elaborate procedures can be performed.

Fescue foot, a metabolic condition caused by a toxic substance in tall fescue, and other foot disorders such as corns between the toes, sprains or strains, and infected cracks can also mimic footrot.

Preventive foot trimming on bulls and old cows goes a long way to preventing a lot of foot disorders. Remember to cull hereditary foot disorders such as corkscrew, claws and corns if they are found on cattle less than three years of age.

### **Lumpy Jaw (Actinomycosis)**

The bacteria causing lumpy jaw gain access to the tissues of the mouth through injuries such as tooth eruption and cuts from sharp awns, like foxtail barley awns. The bacteria localize in the bony tissues, usually the lower jaw. This results in a hard, immovable swelling on the upper or lower jaw. It gradually gets larger and eventually breaks open, discharging a granular straw-coloured fluid. As the swelling enlarges, the affected animal has increasing difficulty with chewing and eventually can't eat. Over a period of several months, the result is severe weight loss.

Because of the bone involvement, treatment may only stop further development of the lesion. Antibiotics and sodium iodide given intravenously are fairly effective in stopping further development of the lump.

Early diagnosis and treatment is the best control for lumpy jaw. If the swelling does not progress and there is no discharge, the cow can be kept as long as weight loss does not become an issue. The swollen jaw is simply a blemish at that stage.

Sometimes the lumps that develop on calves are simply abscesses from abrasions to the mouth and are not lumpy jaw. It is important to differentiate between the two.

Control of lumpy jaw involves avoiding very abrasive feeds. Isolate animals with discharging lesions because the discharge seeds the area with the organism.

## Wooden Tongue (*Actinobacillosis*)

This condition results in a hard, swollen tongue that may protrude from the mouth. Excessive salivation and difficulty in chewing cause the affected animal to lose weight. With all the salivation, the veterinarian may need to check the mouth, throat and esophagus with a gauge to rule out choke. A check for rabies should be done anytime salivation is encountered.

The bacterium *Actinobacillus lignieresii* is very similar to the one causing lumpy jaw. Bacteria gain entry into the tongue through abrasions caused by barley awns, foxtail barley awns or other injuries to the tongue.

Antibiotics and sodium iodide usually result in a rapid recovery, especially if treatment is started early in the course of the disease. Control is the same as for lumpy jaw.

## Pinkeye

This common and costly disease is caused by the bacterium *Moraxella bovis*. Stress factors are also important in outbreaks of this disease. They include excessive ultraviolet sunlight, eye injuries, vitamin A deficiency and irritation from the common face fly. The disease can be spread by contact with infected animals or by face flies that have come into contact with infected secretions. White-faced cattle are more susceptible. This disease is transmissible to humans.

Affected animals have an excessive discharge from one or both eyes as a result of inflammation of the eye linings. As the condition progresses, the cornea (surface of the eye) becomes cloudy, and ulcers may form in the centre of the eye. Exposure to light is very painful and the animal often closes the

affected eye. Weight gains or milk production drop significantly in affected animals. Pinkeye can appear in outbreak form with several animals affected.

Advanced cases of pinkeye can be confused with malignant growths (cancer eye) that require surgery. In very advanced cases, the ulcer may rupture the cornea, causing a pop-eyed appearance. These can be extremely painful and the only solution is removing the eye.

Early treatment of pinkeye is important for both achieving rapid recovery and preventing the disease from spreading. Antibiotic ointments are helpful, but must be applied to the affected eye several times a day. Injecting the eyelid with penicillin and corticosteroids usually gives a good response. More recently, sustained-release, injectable antibiotics (tetracyclines) have proven to be beneficial as they are excreted in the tears. Use of powders should be avoided. A flap may be glued over the eye or the area around the eye can be darkened to minimize sun irritation. A veterinarian should be consulted about the proper method of performing these treatments and which combination works best.

There are several signs that this condition is improving. Once the eye stops draining, the active infection is gone. A white, cloudy membrane appears when healing has occurred. In severe cases a permanent white scar may result, but cattle usually maintain some sight.

Good management practices are of paramount importance to reduce or prevent spread of pinkeye infection in cattle. When possible, separation of infected animals from healthy animals is beneficial. Ultraviolet radiation from sunlight may worsen the disease in cattle. Therefore, affected animals should be provided with shade.

Preventive measures include selecting cattle for dark pigment around the eyes or black cattle, controlling flies and vaccinating. Reducing the number of face flies (*Musca autumnalis*), an important vector for *M. bovis*, can reduce the incidence of pinkeye. Fly control can be achieved through the use of oilers, fly tags (providing control for 90 days) or pour-on insecticides (providing control for 60 days). *Moraxella bovis* vaccines can be administered before the beginning of fly season.



The efficacy of these vaccines is controversial. Although they are unlikely to prevent *M. bovis* infections, immunization may reduce the severity and duration of infection in affected animals (Kahn 2006).

### White Muscle Disease (WMD)

White muscle disease (WMD) is most common in areas with low levels of selenium in the soil, especially areas with Grey Wooded soils. These areas represent a large part of Western Canada. The cause of the disease is a deficiency of selenium and/or vitamin E.

White muscle disease is related to extra or unusual muscular activity. This can occur when calves are turned into pasture after barn confinement or if calves are chased during processing.

The skeletal or heart muscles may be affected. Symptoms are related to the dysfunction of these organs. If the heart muscle is involved, heart failure and sudden death are the result. Affected calves may be weak or die suddenly after exercise. The muscles are often found to be hard or swollen. There may be knuckling of the joints or trembling of the limbs. When the skeletal muscles are involved, calves want to lie down because walking is painful.

Selenium deficiency also results in reduced disease resistance and retained placentas. Deficiency symptoms are usually expressed in calves that tend to lay around, may lack an aggressive suckling ability and/or are chronically stiff.

Vitamin E metabolism is similar to selenium metabolism, and deficiency symptoms are similar. Vitamin E and selenium are usually administered jointly where clinical symptoms occur. In areas where the clinical symptoms have occurred, most producers supplement their calves with injectable

selenium and vitamin E at birth. When giving injectable vitamin ADE, remember that the levels of vitamin E in the supplement are not anywhere near the levels needed for treating white muscle disease. With injectable selenium and vitamin ADE, the vitamin E is used as a preservative. Additional vitamin E may be injected at a rate of 50 mg [68 international units (IU)] of vitamin E per 18 kg (40 lb.) of body weight to treat white muscle disease.

Supplementing selenium and/or vitamin E in the diet can prevent this disease. In Alberta, forages grown west of Highway 2 and north of Highway 16 are usually deficient in selenium. Selenium deficiency has shown up in forages in other parts of the province as well. Therefore, have feed, especially forages, tested for selenium content before supplementing with selenium. The minimum suggested allowance for selenium in the diet is 200 mg/kg. Higher levels than this may be required in some instances. In addition to selenium, supplement beef cows with 200 to 500 IU of vitamin E daily during the last 60 days before calving. (Refer to the *Nutrition and Feeding Management* chapter for more information on selenium and vitamin E.)

The addition of selenium to commercially manufactured supplements for cattle is regulated by Agriculture and Agri-Food Canada. Under current regulations, feed manufacturers can add the levels of selenium shown in Table 65.

Green hay and grains are good sources of vitamin E. However, because rancid fat destroys vitamin E, prepared rations that are supplemented with oils and fats should be fed when they are freshly mixed. They should not be stored for more than a few days.

TABLE 65. Summary of levels of supplemental selenium permitted in cattle feeds

Feed Type	Allowable supplemental selenium levels
Limit-fed feeds	Selenium can be added at a level not to exceed an intake of 3 mg of selenium/head/day.
Complete feeds	Selenium can be added at a level not to exceed 0.3 mg of selenium per kilogram of diet.
Trace mineralized salt	When fed free-choice, selenium can be added at a level not to exceed 120 mg of selenium per kilogram of trace mineralized salt.
Minerals	When fed free-choice, selenium can be added at a level not to exceed 30 mg of selenium per kilogram of mineral.

Selenium is efficiently transported across the placenta of pregnant cows to their calves. Injections of sodium selenite have been used for decades to treat selenium deficiency disease and for selenium supplementation. Although these injections rapidly supply selenium to the animal, they provide only partial selenium supplementation for a period of time lasting from 28 to 45 days. Injections of selenium can be effective as strategic supplementation if given one to two months before calving. Alternatively, if pregnant cows are supplemented with selenium in salt mineral mixes during the last three months of pregnancy, they can easily give birth to selenium normal calves.

However, selenium is not well transferred through the milk. If only the cows are supplemented with selenium after calving, the calves will have normal selenium stores until they are about three to five months old. These calves may have a low weaning weight and are at risk of other selenium deficiency problems if they are not supplemented directly with selenium, either by injections or feeding salt-mineral supplements.

Do not over-supplement selenium. Selenium can be toxic when given in excess.

### Navel Ill (Omphalitis)

Bacteria that enter the body through an unhealed umbilical cord cause navel ill. The navel becomes hot, swollen and tender. A fever is often present and the calf may refuse to suck. Scours, dehydration and depression may accompany navel ill. If the infection enters the bloodstream, two or more joints will become swollen and painful, and the calf will refuse to get up. The prognosis in such advanced cases is grave.

Treatment includes administering antibiotics by injection and cleaning the navel thoroughly, while allowing for drainage. The three keys to prevention are: making sure a calf receives an adequate supply of colostrum (1.5 to 2 L) before the calf is more than six hours old; calving in clean surroundings; and, making sure the dam's nutrition is adequate. If you are weighing calves, try not to handle the navel cords at all. Cords that break off short or are chewed on by the cow allow the infection to more easily wick up inside. Warm, moist areas lead to growth of the bacteria. Under these circumstances a weak calf is likely to get navel ill.

Prophylactic antibiotics are given at birth in herds where there is a high incidence of this problem. Surgery may be performed on valuable calves with advanced cases of navel ill. The surgeon follows the blood vessels up to either the bladder or liver to make sure the entire infection is removed.

### Mastitis

Mastitis is inflammation of the mammary gland (udder). There are over 100 different types of mastitis-causing organisms. Unlike the dairy industry, most cases that occur in beef cattle are chronic or acute.

Acute mastitis is common right after calving when organisms gain access from the environment as heavy producing cows leak milk. The udder becomes swollen and hard, with one or all quarters involved. The cow is visibly sick and runs a high fever. Some bacteria produce gas and the quarters involved may become gangrenous. When the udder is stripped out, the discharge is often more like water than milk. Veterinarians will recommend the use of antibiotics, both injectable and intramammary. Constant stripping of the quarter helps to physically remove the organism.

Chronic mastitis infections have most likely been brewing since the previous season. These infections often affect cows with bottle-like teats. Calves do not suck these teats properly and stagnant milk is often the result. Stagnant milk is a great breeding place for infection. The discharge is very often thick and yellow. The common organism here is *Corynebacterium*. These infections do not clear up without treatment and with time the entire quarter of the udder may become gangrenous and slough off.

In dealing with chronic mastitis, the veterinarian may have you try and dry up the affected quarter. Products developed for this purpose are infused up the teat and create a chemical mastitis. Note that it is difficult to cause one gland to dry up while the others are still trying to produce milk. The veterinarian may have you use a dry cow treatment as the calf is weaned.

It is very important to cull cows with pendulous (drooping down and swinging) udders and poor teat structure. The selection of replacements should come from cows with good udders. This helps maintain longevity in the herd.

## Warts

A virus (*papova*) that enters the body through skin abrasions causes the common wart in cattle. It can be spread directly by contact with infected animals or indirectly on instruments such as hypodermic needles, ear taggers and tattooing equipment.

Warts appear as cauliflower-like lesions on the head and neck of affected animals, but may spread over the entire body. Young animals are most often affected.

Treatment is not normally required as warts disappear spontaneously in the majority of animals. Autogenous vaccines (made from warts on your farm) have been successful in some situations. Warts can also be surgically removed. Removing warts through surgery or twisting them off helps establish immunity quicker and usually other warts will regress. Occasionally, warts will form on the penis of a breeding bull. A veterinarian can spot these during a semen evaluation and often they can be surgically removed. Once recovered, cattle seldom contract warts again.

This condition is not an economic disease unless the warts start to grow together to form infected masses.

Preventive measures include isolating infected animals and keeping surgical instruments clean.

## Ringworm

Ringworm, which is caused by several types of fungi, occurs commonly in animals housed inside and close together for long periods of time.

*Steer with ringworm.*



Young animals are affected more often than adults because animals build up immunity over time. The disease is spread either directly from animal to animal or indirectly by contact with contaminated bedding, stalls or grooming equipment.

A grey-white circular crust rising above the skin is commonly observed on the head or neck, but it may appear on any part of the body. These lesions are usually not itchy and clear up spontaneously. Ringworm will not reduce performance unless it spreads over large areas of the animal's body.

Be sure to use caution when treating affected cattle because ringworm spreads easily to humans and is much more difficult to treat in humans. Use gloves and thoroughly clean up after treating cattle.

Scrub the lesion with a stiff brush, and then apply a topical medication such as a mild iodine solution (Kopertox or Thiabendazole). Do not use the scrub brush for any other application. Generally, two treatments one week apart are recommended.

As a preventive measure, make sure the mineral you are feeding has adequate levels of vitamin A. Vitamin A is necessary for healthy skin and is often given as a single shot to treat ringworm.

Ringworm appears to clear up spontaneously when cattle are put on pasture because the sunlight helps kill the fungus, and grass has high levels of vitamin A.

Thoroughly disinfect clippers used for grooming as animals can carry spores in their hair without developing lesions. Disinfect contaminated pens or buildings with solutions of 2.5 per cent to five per cent phenol, or 0.25 per cent sodium hypochlorite or two per cent formaldehyde mixed with one per cent caustic soda.

A vaccine for ringworm is now available. Although it is expensive, it is quite effective. For producers with an extreme problem or show cattle, it could be an option.

## Water Belly (Urinary Calculi)

Urinary calculi (stones) are formed by the crystallization of mineral salts in the urine. The small stones block the passage of urine through the penis.

Water belly occurs in steers and, to a lesser extent, bulls. This is because the males have a longer and smaller urethra, allowing a stone to be lodged. Initial signs are stretching, stamping of the hind feet, tail switching and straining while trying to urinate. Complete obstruction of the urine flow will rupture the urethra (in the penis) or the bladder. At this stage the pain from the full bladder disappears, as do earlier symptoms. A ruptured urethra causes a large swelling under the skin of the belly. A ruptured bladder results in accumulation of the urine in the abdomen, giving the calf a bloated appearance.

Feeds high in silicates or feeds with the mineral phosphorus occurring in higher levels than calcium are commonly associated with water belly. Areas in the southern half of Alberta have a higher incidence of this problem due to the high silicate rough fescue that is grazed.

Feeding high levels of grain, such as in many finishing programs, frequently leads to calculi formation and urethral obstruction. Thus, any feeding program incorporating concentrate feeding must include appropriate calcium supplementation. The most important factor is to provide a calcium to phosphorus ratio between 1.5:1 and 2:1 in the complete ration.

Traumatic cases can occur from botched Burdizzo jobs, where the penis is accidentally crushed. With surgery the penis is brought out the back, shortened and the trapped urine is drained. If performed early, most veterinarians have a 75 per cent success rate using this procedure.

Slaughter is an option provided the urethra or bladder has not ruptured. If a rupture has occurred, surgery is the only method of treatment. It is much more successful if done early.

In areas of high incidence, late castration is used as a preventive measure. It allows the urethra to grow larger.

Several preventative preventive measures can be taken.

- Keep calves intended for slaughter off high silicate content pasture.

- Provide an adequate water supply. Water supplies should be checked if a cattle operation has several cases of water belly. Heating the water in the winter time may improve water intake.
- Induce animals to drink more water by increasing the salt intake. Ingestion of salt at a rate of about 1 g/kg body weight increases water intake enough to eliminate calculi formation. This can be accomplished by providing a grain mix, supplemented with 15 per cent salt, in a creep feeder for calves beginning at about four months of age (Cheeke 1998). This should be fed continuously through the first winter until the calves are about one year of age in order to reduce the formation of urinary calculi. When salt is provided loose or as a lick, it is not be consumed in sufficient amounts to influence water intake.
- Evaluate the ration. In operations with a significant urinary calculi problem, this is the most important measure to reduce the incidence.

## Spondylitis

This condition is a form of arthritis. It results in new bone proliferation on the vertebrae. This causes swelling, which puts pressure on the spinal cord and causes varying degrees of paralysis to the hindquarters.

Spondylitis is usually seen in older, overweight bulls that have been used primarily for breeding on rough pasture. Weakness or paralysis of the bull's hind legs may develop slowly or appear suddenly. The bull may appear drunk with staggering and lameness on the hind legs only. The bull may also look apprehensive or bemused. The bull can be made to fall to the ground by pulling on his tail.

No treatment is available for this condition. If the bull is able to walk, emergency slaughter is recommended before the condition progresses and results in a downer. Full slaughter value can be obtained in some cases.

Early in the breeding season is a common time to see this condition. It is only rarely seen in cows.



# Administration of Drugs

Throughout the entire management cycle of your beef operation there is hardly a time when some animals in your herd are not being administered some sort of animal health product. You can help to maintain and improve beef quality by being certain that these products are handled and administered properly. When handled properly, cows and calves will have less stress, consumers benefit and your bottom line is improved.

When administering animal health products, follow these tips:

- Consult a veterinarian on proper use of all medicines.
- Restrain animals properly before injecting.
- Give subcutaneous (under the skin) shots in the neck area or above the shoulder blade and use pour-on products whenever possible. Most new injectable vaccines and antibiotics are being formulated for subcutaneous injection because it minimizes any damage to the muscles.
- If it is necessary to give intramuscular injections, use the neck region to avoid the high priced cuts over the hip.
- Keep the injection site clean.
- Change needles after every 10 to 15 animals when injecting. This avoids abscesses and other disease problems from dirty needles.
- Read and follow label directions:
  - Follow label dosages, frequency of treatment and length of treatment.
  - The drug is most effective when used according to the manufacturer's time regime.
  - Follow the route of administration.
  - Follow the withdrawal period strictly and keep good records.
- Store the drug according to label directions.
- Use transfer needles to reconstitute vaccines.
- Don't mix more vaccine that you will use during a one-hour time frame.
- Keep vaccines out of the sun and in a cooler to prevent degeneration.
- Use separate syringes for each type of vaccine being given.
- Don't combine different antibiotics and vaccines in the same syringe.
- Use proper syringe technique. For example, avoid administration of air and use the proper injection technique.
- Use the injection site recommended.
- Use the injection site that damages the least amount of high-priced muscle.
- Keep syringes, vaccine bottles and needles clean.
- Use the proper size of needles for the injection route, site and product being given.
- Keep the animal needles out of the vaccine bottles.
- Discard needles when they are bent, dull or burred.
- Develop a record keeping system for all drug administration to each animal.

## Avoiding Antibiotic Residues

Drug residues are rarely found in slaughtered beef carcasses in Canada. This indicates that most livestock producers and veterinarians are using antibiotics responsibly. Nevertheless, there is still a significant degree of consumer concern regarding the presence of drugs and chemical residues in meat and milk.

Consult your veterinarian regularly about what drugs are or are not to be used on the farm. Follow label directions and obey stated withdrawal

times to avoid residues. The withdrawal period is the interval between the removal of the medicine and the permitted time for use of the milk or meat for human consumption. Withdrawal times vary with the drugs used, dosage and the route of administration. Remember that drug residues do not reach an absolute zero level within the stated withdrawal period. Withdrawal times assist in attaining low residue levels to meet government regulations for human health.

Table 66 lists some commonly used antibiotics in beef cattle and the appropriate withdrawal times. Always check the label of the antibiotic, insecticide or vaccine and follow the withdrawal directions.

TABLE 66. Withdrawal times for some antibiotics, insecticides and vaccines

Product (company)	Route	Withdrawal time
Aureomycin® Vitamin premix Crumbles	Oral	5 days
BRSV Vac® (Bayer)	Intramuscular	21 days
Bovaid® Fly Tags (Novartis) Bovaid <i>Note: Remove tags before slaughter.</i>	Ear tags	0
IBR-P13 48TM (Boehringer)	Intramuscular	21 days
Ivomec® Injection for Cattle (Merial)	Subcutaneous	35 days
Oxy LA (Citadel)	Intramuscular	28 days
Oxy LP (Citadel)	Intramuscular, intravenous	18 days
MGA 20 (V-S Feed & Agri Supplies)	Oral	48 hours
Trivettrin™ Injection Pr. (Schering-Plough)	Intramuscular, intravenous	10 days
Tylan® 200 (Elanco)	Intramuscular	21 days
Penmed (Medprodex)	Intramuscular	5 days
Penlong XL Pr. (Pfizer)	Intramuscular	14 days

Animal health products may be administered in a variety of ways. To determine the best route of administration, follow the label instructions. If you are still unsure about how to administer the product, contact your local veterinarian.

TABLE 67. Abbreviations for drug administration methods

IA	intraarticular	IM	intramuscular
IMM	intramammary	IN	intranasal
IP	intraperitoneal	IR	intraruminal
IU	intrauterine	IV	intravenous
SC	subcutaneous		
d	days	h	hours
C	controlled drug	Pr	prescription

## Methods of Administering Medications

Table 67 lists abbreviations used in the livestock industry for the administration of animal health products.

### Injections

#### INJECTION EQUIPMENT

Using the proper injection equipment when administering medications and vaccines is an integral part contributing towards high beef quality. Remember, that infected needles can spread diseases and cause abscesses.

When vaccinating, change needles after every 10 to 15 animals. Also change the needle if it has become burred, bent or blunt. Disposable needles are more desirable than steel needles as they maintain their sharpness and can be disposed of at low cost. New needles that can be detected by metal detectors at packing plants are now being manufactured to enhance the safety of the industry.

Before filling a syringe, the cap of the bottle should be wiped clean and a sterile needle inserted into the bottle. This needle should be left in place and syringe filling should take place via this needle. This avoids contaminating the material left in the bottle.

Several automatic syringes are available on the market and they are commonly used during the mass processing of cattle. The accuracy of these has greatly improved over the years. Accuracy is extremely important as a lot of vaccines have a dosage of only two cubic centimetres (cc). It is essential to calibrate all equipment prior to administering medications or vaccines to ensure proper dosage.

Use the proper needle size for the desired route of administration, the size of the animal and the viscosity (thickness) of the product injected.

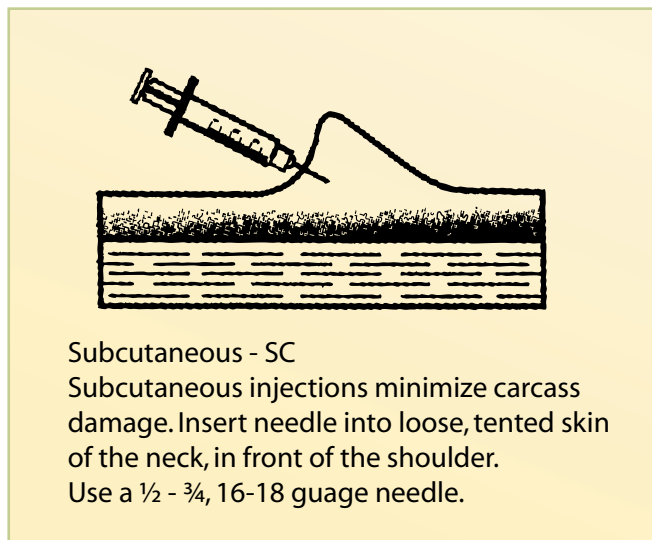
- for subcutaneous injections, use a 16 or 18-gauge needle from  $\frac{1}{2}$  to  $\frac{3}{4}$  inches long
- for intramuscular injections, use a 16 or 18-gauge needle from  $\frac{3}{4}$  to  $1\frac{1}{2}$  inches long
- for intravenous injections, use a 14 or 16-gauge needle 1 to 2 inches long
- use subcutaneous injections instead of intramuscular whenever possible
- a 16-gauge needle is the most commonly used size for large animals
- remember, the higher the gauge, the smaller the size of the needle
- for newborn calves, use a 20-gauge needle
- if unsure, ask your veterinarian which size is ideal for the intended purpose
- If a needle breaks:
  - Mark the animal immediately.

- Try to retrieve the broken needle.
- If the needle isn't retrieved, mark the animal permanently.
- Enter a note in your records, including animal ID.
- Call packer before shipping to allow separate processing.

## SUBCUTANEOUS INJECTIONS

The ideal location for a subcutaneous injection is any point where there is loose skin. The location should also be accessible and not dangerous for the operator. The skin over the neck and shoulder blade meets these specifications. The loose fold of skin in front of the brisket is often used and so is the skin over the chest, near the elbow. Newer chutes are being designed to provide good access to these areas.

Shorter needles are used for these injections. If only longer needles are available, insert them at an angle. The skin should be picked up between the forefinger and thumb (Figure 58). Then the needle should be thrust in to its full depth, parallel to the underlying structures. Make sure that the tip of the needle doesn't lodge in the skin itself, thus blocking the opening of the needle. If the needle is inserted at an angle, it greatly facilitates delivery of the product just under the skin.

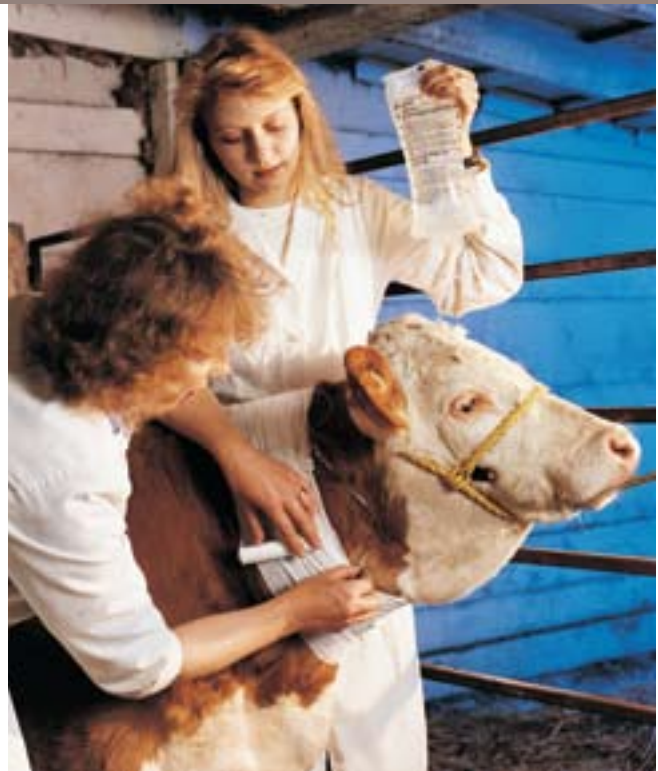


**FIGURE 58.** Subcutaneous injection

## INTRAMUSCULAR INJECTIONS

Intramuscular injections are absorbed relatively quickly and must be given into heavily muscled masses that are located away from bones and joints. Give all injections in the neck area, away from the hip. Intramuscular shots are not given in the hip area to avoid the high priced cuts of meat from this area. All intramuscular shots, especially when high volumes of product are given, cause scarring in the area. These result in gristle (scar tissue), which makes the meat less desirable.

Make sure you have the animal fully secured before giving the injection. A 16 to 18-gauge needle should be used for this type of injection. The needle length will vary depending on the size of the animal. To insert the needle, remove it from the syringe, grasp the butt of the needle firmly between the thumb and index finger, and sharply stab the needle into the selected site (Figure 59). The syringe should be reattached to the needle and the plunger slightly withdrawn. If blood appears, the needle must be relocated. If the needle is not relocated the product is injected directly into the bloodstream. With some products this causes an allergic reaction. These injections should be made slowly because they can be painful if given rapidly.

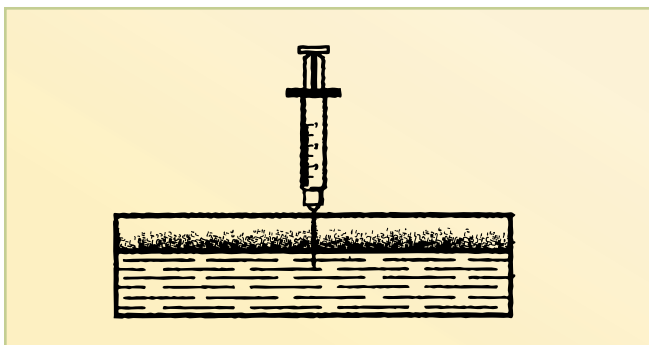


*Intravenous injection.*

They start to act immediately and there is no muscle damage. Restraint is crucial and there is a skill that must be acquired. Generally, veterinarians administer products intravenously as they have the ability and knowledge to accomplish this. They also know which products can be safely given intravenously. Certain products must also be given slowly to prevent cardiac shock. A veterinarian should provide advice about or help with the administration of these products.

## SUB-CONJUNCTIVAL INJECTIONS

In serious cases of pinkeye, the introduction of drugs into the conjunctiva (pink tissue under the lids) that lines the upper eyelid has considerable value. Fine needles, 20-gauge or smaller, are best for this purpose. With the head rigidly restrained, the lining of the upper lid may be rolled outwards with upward pressure to the eyelid. Then the needle is inserted beneath the conjunctiva. Note that the needle passes close to sensitive structures of the eye. Therefore, it is advisable to have a veterinarian demonstrate this technique. Always have the needle pointed away from the eye in case of sudden movement. Drugs are then released over time into the area around the eye. Only small volumes of antibiotics can be injected into this area (1 to 3 cc).



**FIGURE 59.** Intramuscular injection

Most new products are being formulated to give subcutaneously. This avoids damage to the muscles and absorption takes only a few minutes longer.

## INTRAVENOUS INJECTIONS

Farmers are advised to seek veterinary advice before attempting to take this action. These injections are made directly into the bloodstream.



## In Drinking Water

Some products are formulated for use in drinking water. This applies when mass medication is in order. Fortunately, sick cattle often still drink after their feed consumption stops.

The medication is either added to a large tank or through medication dispensers that provide a preset amount of medicine into the waterline. For medication in water to work, no other source of water can be available to the cattle. Make sure the medication is formulated for use in water. Effectiveness after mixing must be maintained until all the water is consumed.

Most products for use in water are flavoured so consumption is not depressed. Flavours such as strawberry or apple gelatin can be added to mask undesirable tastes. Cattle are more particular about the taste of water. Even the introduction of chlorinated water suppresses consumption for 24 to 36 hours.

Follow all drug withdrawal requirements. Remember to calculate the amount of medication for all the stock that are drinking, as the healthy animals are also being medicated.

## In Feed

Some medications are given in rations to treat or prevent disease and to improve animal performance. As with any form of medication, improper handling of feed additives can contribute to drug residue problems. (Refer to the *Nutrition and Feeding Management* chapter for more information on feed additives.)

## Drenching

The art of drenching (providing liquid by mouth) lies in allowing the animal time to swallow. Usually, a 750-millilitre (mL) unbreakable bottle makes a convenient drenching vessel. The product being given must have taste to stimulate swallowing. Mineral oil by itself should not be drenched as it's highly likely that the animal will get some into the lungs.

With the animal restrained in a stanchion or chute, stand on the left side of the animal's head and place your right hand on the side of the animal's nose, below the eyes. Then slip your hand into its mouth, and hold the upper jaw by the dental pad (the toothless upper jaw). The animal will then open

its mouth automatically, allowing you to pour some product inside. Do not elevate the head more than a few degrees above horizontal. Do not hold the bottle too high so that the mouth becomes flooded. During this procedure the animal will chomp and swallow, and ideally drink the medication a little at a time. Be careful not to get your fingers between the back molars. Keep your hand on the dental pad until the drenching is finished.

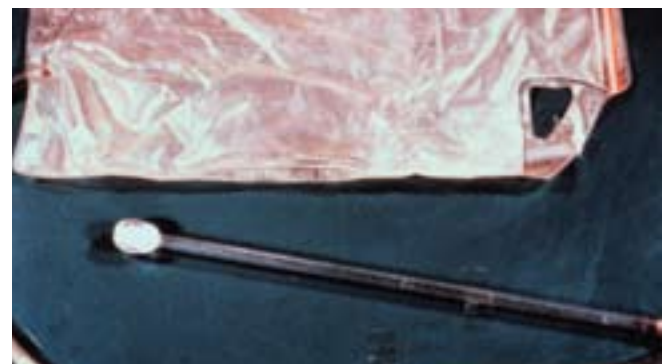
## Stomach Tubing

The use of a stomach tube is not recommended unless the operator has been thoroughly trained in the procedure. A stomach tube may be used to relieve bloat or to administer large quantities of fluid. For most animals, the tube should be 13 to 19 mm (0.05 to 0.07 in.) in diameter, with a thick, firm wall. It should be at least 2 m (6 ft.) long.

For baby calves (less than two months old), a human enema tube or special esophageal feeder should be used. These feeders have a stiffer tube with a flared end to stimulate swallowing. You can also palpate the tube going down the esophagus to ensure that the lungs are not flooded. These feeders or the human enema tubes are used to give baby calves colostrum in the hours immediately following birth or electrolytes for treating calf scours.

With the animal adequately restrained in a chute, the tube is inserted into the mouth. For adult animals a speculum (hard tube) is placed inside the mouth and the tube passed through it. The presence of the speculum prevents the animal from chewing the tube and stimulates a swallowing action. Using gentle pressure, the tube is passed through the speculum and down the throat. On passing down the neck, the tube may be palpable from outside. Only rarely is it passed into the lungs. On mature animals it is not always possible to feel or palpate the tube going down.

*A fluid administration kit.*



Check for the odour of ruminal contents coming up the tube. This indicates that the tube has passed into the rumen. If still in doubt, you can blow down the tube and listen for a bubbling sound in the area of the last rib on the left side to ensure that it is in the rumen. Coughing or gagging is a sure sign that the tube is in the trachea (windpipe). If you hear coughing or gagging, remove the tube immediately and try re-inserting it more carefully. Pumping fluids directly into the lungs can kill the animal.

## Balling Gun

Many medications may be made up as capsules or boluses, which may be administered by using a balling gun. Rumen magnets may be given in the same way.

Good restraint is important. The balling gun should only be placed over the prominence at the back of the tongue before the bolus is released. If used incorrectly, a balling gun can inflict serious injury to the mouth or throat tissues. Take care not to cause mouth injuries and be quick when discharging the product out of the balling gun.

Plastic balling guns get very chewed up and should be discarded after several uses. Stainless steel balling guns should be disinfected after each use.

If the product is swallowed, the cow will lick its nose. This is a surefire sign that swallowing has occurred. Allow a few seconds after administration to make sure this has happened. Improper application of the bolus results in gagging, salivation and the bolus is spit out.

## Medications in the Uterus

### TABLETS

The value of placing tablets in the uterus after calving is low because the procedure is more likely to introduce an infection to the animal. The operator must wash the vulva with disinfectant solution and must use a new disposable plastic glove for each animal that is treated. The tablets should be well separated in the uterus and placed as far forward as possible in the uterus, after the

cow's afterbirth has been adequately cleaned off. Most veterinarians now advise systemic antibiotics as a better way to treat intrauterine infections.

## UTERINE INFUSION

Uterine infusion is the use of pipettes, similar to those used for artificial insemination, for inserting liquid products into the uterus. Inexperienced operators should not attempt this technique. Only a few products are cleared for usage in the uterus. The uterus is easily irritated and scarring can result in infertility. Use only recommended products and make sure the withdrawal information is known and followed. Your veterinarian can advise on which product to use and what cases will benefit.

## Topical and Pour-on Medications

Topical medication is applied to the external surfaces of the animal's body. This type of medication is used in the treatment of ringworm, lice, wounds and pinkeye. When topical medication is applied extensively, such as for warble control, the manufacturer's instructions must be followed and the operator should wear protective clothing. Rubber gloves are recommended in case spillage occurs.

Pour-on products need to be applied properly. Rain or snow interferes with absorption. Excessive tag (dirt and manure) or excessive shedding prevents proper absorption through the hair follicles. Product application guns should be working properly. Discard them if they are sticking.

## Intramammary Medication

Prior to treatment, the udder should be completely milked out. Milk from a mastitic quarter is infected and flies or hands can easily transmit the infection. Follow the label recommendations for the proper insertion technique. Adhere to label withdrawal time requirements and only use single treatment syringes up the teat end.

The teat end should be disinfected with alcohol pads or an approved teat dip before treating. All the medication in the syringe should be injected

(infused) into the teat canal. When you administer intramammary products, use a short infusion cannula (3 mm) using the partial insertion technique. This reduces the chance of forcing micro-organisms into the teat cistern. The quarter should then be massaged to distribute the drug. After treatment, disinfect the teats again with an approved disinfectant or teat dip.

## Caring for Sick Animals

### Signs of Disease

Beef cattle usually show they are not well by abnormal activity and appearance. Before you can recognize an abnormality, you have to become thoroughly familiar with the normal behaviour, habits and appearance of the healthy animals you have under your care. Although the first signs of disease are often slight and easily missed, early detection of these signs can result in early treatment, speedy recovery and prompt control of the situation.

One of the first signs of disease is a change in behaviour. Some of the behavioural changes that indicate disease are: not eating (or off feed), reluctance to get up and walk, separation from herdmates, showing pain by kicking the belly, rapid breathing, groaning or grunting when forced to walk, irritability, uncontrolled body movements (convulsions), excitement or mania, or excessive straining.

Another sign of disease is a change in appearance. Some of these are: unusual stance, loss of body condition, hair loss, enlarged joints, droopy ears, snotty nose, crusty muzzle or dull hair coat.

Once you have observed visible signs that an animal is sick, you need to examine the animal more closely. First make a general inspection of the animal and then do a detailed examination. Carry out the general inspection from a distance to avoid upsetting the animal. This allows you to detect unusual behaviour that may not show once the animal has been disturbed. Observe the animal from different angles to determine what body

system(s), if any, appear to be most affected. Note the general demeanour of the animal. Evaluate body condition and appearance of hair coat. Note the rate and depth of respiration, as well as the presence of abnormal discharges or absence of normal secretions.

After the general inspection, remove the sick animal from its healthy herdmates and place it in isolation. Restrain the animal in a chute or head gate in order to conduct a more detailed individual examination. Measure the animal's vital signs including temperature, pulse and respiration rate. Record the body temperature at the start of the examination, after the animal has calmed down. Deviations of the vital signs from normal should be interpreted, as they may help you describe the signs of disease to the veterinarian.

### Temperature

An animal's body temperature is generated and maintained by basal metabolism, muscular activity of the body and the heat lost from the body. Approximately 85 per cent of heat loss occurs through the skin. The remainder is lost via the lungs and through digestive and urinary secretions. Abnormal body temperature is often a very reliable indicator of disease. When an animal's temperature is above normal limits it is considered to have a fever.

Domestic animals do not have a constant normal temperature. In general, animal temperatures vary with physical activity, stage of pregnancy, the time of day and environmental surroundings. The normal rectal temperature of mature cattle is 38.5C (101.5F). Generally, body temperature does not exceed 41.7C (107F) in cattle. If the temperature gets into the critical range of 40.5C (104.5F), consult your veterinarian immediately. Normal temperatures for baby calves ranges between 37.7C and 39.2C (99.8F and 102.5F).

### Pulse

The pulse rate is mainly a reflection of the force and rate of the heartbeat. Taking a pulse requires practice and its interpretation requires experience. Although it is not generally used by livestock owners, it is still useful to know how to take a pulse and what is considered a normal pulse.

The pulse rate has even greater variation than body temperature and is affected by age, size, exercise and the physical and emotional state of the animal. Disease conditions affecting the pulse rate are diseases characterized by fever, panting, colicky abdominal pain and acute inflammatory conditions. The usual sites for pulse taking are at the lower edge of the jaw, the inner surface of the upper part of the foreleg or high up under the tail. The average normal pulse rate for cattle is 60 to 70 heartbeats per minute.

## Respiration

Respiration consists of inspiration and expiration. Inspiration, or chest expansion, results in the flow of air into the lungs. Expiration is the expulsion of air from the lungs. When you examine respiration in an animal, check the following:

- Count the number of inspirations per minute (the rate of respiration). Compare this number to the normal range of 10 to 30 inspirations per minute for cattle.
- Note the character of breathing. Normal breathing involves an observable expansion and relaxation of the ribs and abdominal wall. Abnormal breathing can indicate disease. Check for rhythm, which is the regularity of inspiration and expiration patterns.
- Listen for sound. Normal breathing is very quiet except when the animal is exercising or at work. Snuffling, sneezing, wheezing, rattling, honking or groaning indicates that something is wrong.
- Check for laboured or difficult breathing (called dyspnea).

## Treating Your Own Animals

A correct diagnosis is essential before you can start treatment. This requires skill in diagnostic techniques and the ability to differentiate diseases that show similar signs. Many cattle owners can and do treat disease conditions in their own animals. The extent to which you can diagnose and treat your own stock depends on your knowledge, experience and natural aptitude for such things. Some people are much more competent than others. Know

your limitations and develop an excellent working relationship with your veterinarian.

The sooner you call your veterinarian after you notice a sick animal, the better the chance there is of successfully treating it. You can maximize the benefits from your vet's visit by doing the following:

- be there when the veterinarian arrives
- confine the sick animal in suitable quarters, with the necessary restraint facilities and other necessary equipment ready
- if the animal is outdoors, arrange temporary shelter in inclement weather
- provide adequate lighting at night
- provide plenty of warm water, soap and a clean towel
- if you are required to give follow-up treatments, make sure you fully understand the treatment instructions before the veterinarian leaves

All disease treatment must be supplemented by good nursing. Good nursing means keeping the animal clean and comfortable, and helping it to perform essential functions that it cannot do by itself. Good nursing often spells the difference between success and failure in the treatment of disease. Although there are many powerful and effective drugs available, medication alone will not produce a rapid and complete recovery. The best results come from the use of the proper medication in combination with the simple nursing procedures listed below:

- Provide plenty of clean bedding, both for comfort and to help the animal to retain body heat in cold weather.
- Provide shade and good ventilation during hot weather to prevent heat stress.
- Provide fresh feed daily. Remove leftover feed at each feeding and replace it with fresh feed in smaller amounts. An animal that will not eat of its own accord often eats when food is placed in its mouth. Ensure the animal is alert and able to swallow.
- Feed easily digested carbohydrates that provide a quick source of energy.



Supplement vitamins, especially B vitamins. Extra protein may be necessary, depending upon the condition of the animal and nature of the disease. Consult your veterinarian.

- Provide fresh, clean water and change the water often. Sick animals tend to slobber in their drinking water and food causing it to develop an odour that is unpalatable to the animal. Animals that will not drink on their own may be given water by a stomach tube.
- Maintain animals that are unable to get up in the position that they normally adopt when they rest. Prop them up with straw bales to help keep them upright. Cattle should not be left lying on their side. In this position they bloat quite readily and die unexpectedly.
- If possible, turn downer animals every three hours, both day and night. This prevents bed sores which develop when prominent parts of the body are in constant contact with the ground.
- Remove manure frequently to prevent soiling of the animal's legs, skin and genitalia.
- The muzzles of animals suffering from respiratory diseases are often encrusted with dried nasal discharges, making it difficult breathe. Moisten this material and then wipe it off to enable the animal to breathe a little easier.
- Isolation is an important disease control or biosecurity measure. It is critical to put a sick animal in a place that features little or no stress and easy access for treatment.

Above all, have consideration and compassion for the animals in your care. Be patient with your sick animals and give them a chance to recover successfully.

## Care of Downer Animals

A downer is defined as an animal that cannot rise, remain standing or walk without assistance. Animals invariably seem to go down in unsuitable or inconvenient locations. If you have to move a downer, the following procedures are recommended:

- For short distances of about 3 m (10 ft.) or less, the animal may be slid along on its side on a layer of dry straw. Traction should be applied to a halter and a rope attached to the under forelimb. A rope around the hindquarters can also be used to give assistance.
- For longer distances, a skid must be provided. A field gate may also be used. The apparatus should be covered with a tarpaulin and straw. Then, the animal should be rolled onto the skid, on its side. The head should be tied down and the entire load hauled away by tractor. Care must be taken that the ears and tail do not get caught between the skid and the ground.

Downers must be given protection from the elements. Place the animal in a well drained location. A base of damp bedding (manure pack) about 225 mm (9 in.) thick should be covered with an equal layer of dry bedding. Many downer animals could rise if they had good footing, but fail to do so because they lose the will to try when the floor is slippery. Hard, slippery floors, such as cement floors, are dangerous and should be avoided at all costs.

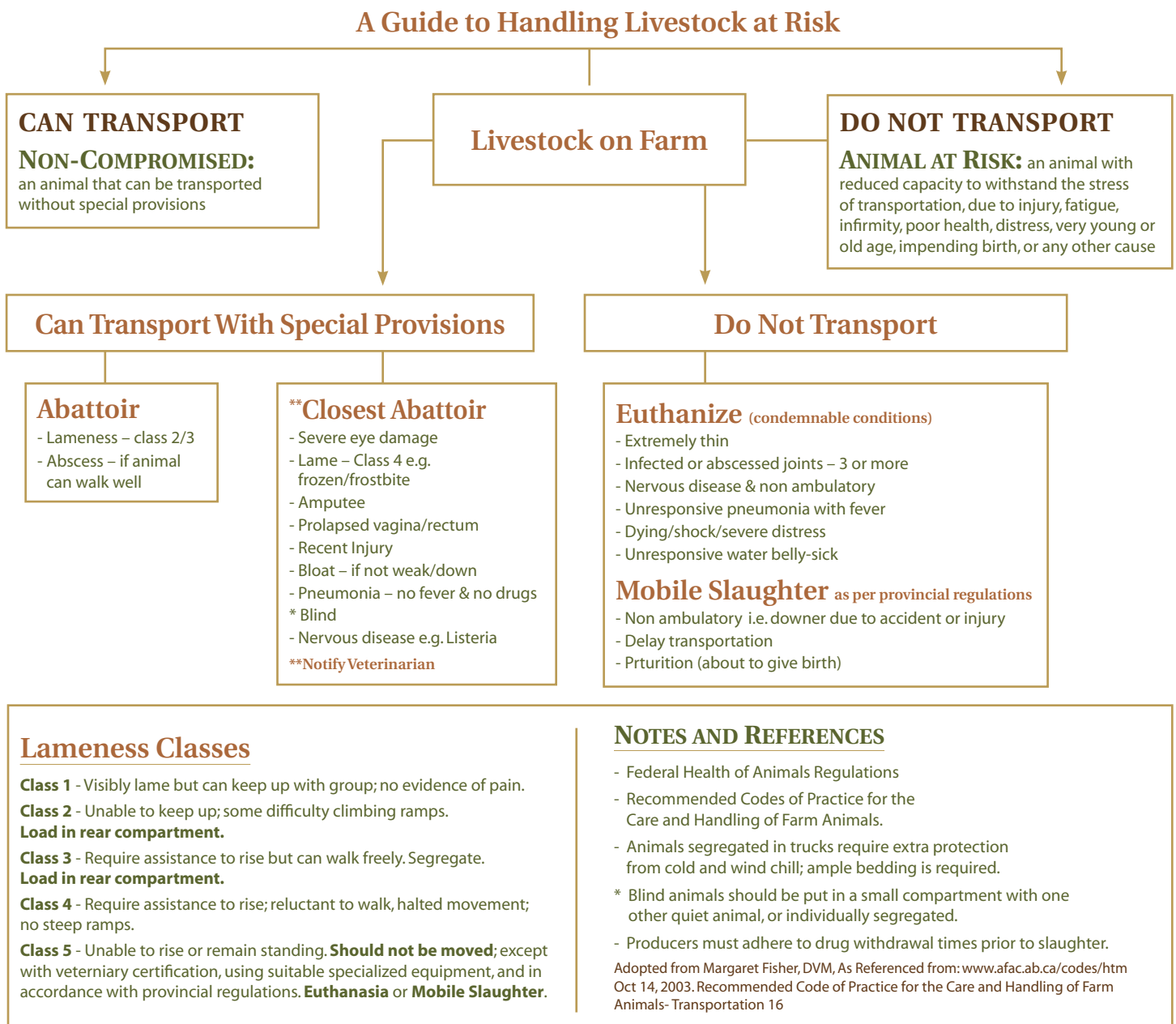
A weak animal tends to lie continuously on one side. The weight of the body compresses the blood vessels, nerves and muscles of the lower limbs and reduces the animal's functional status. A downer animal must be turned every three hours, both day and night. Make sure these animals are left in a natural sitting position, or prop them up with straw bales.

Moving a bulky animal from side to side can be a near impossible task for two men. However, a 3-m (10 ft.) rope can be of assistance if it is drawn under the body by "sawing" forward under the buttocks. One end may be applied around the lower foot and the other end pulled over the body. This technique enables one person to roll an animal quite easily.

If, while you are attempting to get an animal up, its legs keep spreading apart (splay legging), the back legs can be hobbled to allow 0.6 m (2 ft.) of space between them. Use either commercial hobbles or a soft cotton rope. Hobbles allow one leg to support the other when the animal attempts to rise.

Hip lifters should only be used when the animal is making good attempts at rising. The animal is lifted and then allowed to bear some of the weight. Do this for 15 minutes, twice daily. All-body slings have been developed to allow weight transfer, evenly minimizing the pressure points. Cattle can be transported in these devices and lifted for extended periods of time.

Sick, injured and disabled cattle, in severe distress, should not be subjected to the rigours of loading and transportation. These animals should be slaughtered or euthanized on farm. Under no circumstances should a sick, injured or disabled animal be transported to a livestock auction market, or long distances to a meat packer. Slaughter at local abattoirs is an alternative if the animals are free of residues and have a salvageable meat value. Figure 60 is a decision tree that was developed by Dr. Margaret Fisher, DVM, of the Canadian Food Inspection Agency. It is a guide for handling cattle at risk and is recommended by the Alberta Farm Animal Care Association.



**FIGURE 60.** A guide to handling livestock at risk

## Zoonoses (Transmissible to Humans)

Zoonoses are diseases that humans can catch from animals. Producers, especially when treating their livestock, must be diligent about cleaning up afterwards and using gloves in situations that warrant it. Extra precautions, including extra hygiene, must be taken with zoonotic diseases. People with poor immune systems or those on immune-suppressing drugs should avoid handling animals.

If postmortems are done on sudden deaths, your veterinarian can work with your medical doctor in cases where a zoonosis is a threat. Often you will find your veterinarian is a better source of information about zoonotic diseases as he/she has more experience with them.

Always have any strange neurological behaviour by an animal checked out by a veterinarian. Have any bites checked over by your family physician, regardless of the type of animal involved.

The federal government requires reporting of the most serious zoonotic diseases. Keep a list of those diseases that have a zoonotic potential.

Brucellosis was a common zoonosis that caused undulant fever in humans and abortions in cattle. In the past, many veterinarians contracted this disease when they cleaned cows as a way to treat retained placentas. During the removal of the placenta veterinarians were exposed to the organisms. The infection of humans was a major reason that a concerted effort was made to eliminate brucellosis in Canada. The use of obstetrical gloves eliminated exposure to brucellosis and many other diseases that could inhabit the reproductive tract of cattle.

Anthrax, another zoonosis, is fortunately rarely seen. Humans generally develop a milder cutaneous (of the skin) form of the disease.

Ringworm is the most common zoonosis. It is far harder to treat in humans than in cattle. Use gloves when treating infected animals and don't reuse the instruments on healthy cattle. Make sure you clean up extremely well using a good fungal disinfectant.

Rabies is the most dreaded zoonosis because it is fatal to humans. Although rare in Alberta, it does occur. Alberta's rat patrol keeps one potential source of rabies out of this province by patrolling the Saskatchewan border. The patrol also keeps a close handle on skunks, another potential carrier. However, bats are the main carriers of rabies in Alberta. Any animal exhibiting strange behaviour is a suspect and may need to be submitted to a diagnostic lab. Make sure to keep family pet shots up to date. Another important point to remember is that rabid animals die quickly enough to have them tested, and have any humans preventively vaccinated.

Over the last several years, hanta virus has been diagnosed with increased frequency on Alberta farms. This disease starts as flu-like symptoms in humans and progresses to pneumonia. It is contracted from the virus present on the droppings of deer mice. Mouse-proofing your buildings can prevent this disease. Droppings should be wet down with bleach before they are removed. Use a mask when dealing with mouse droppings to prevent inhalation of the virus.

Many other zoonoses can be contracted on the farm. Each livestock and pet species has its own list of potential zoonotic diseases. Be familiar with those zoonoses in your area so that you and your family are protected. Follow the hygienic principles talked about in the Biosecurity section to help prevent disease at your farm gate.

## Biosecurity

Biosecurity means protecting the health of your livestock by preventing the introduction of disease. This introduction could come from a different country, a different farm or within your own farm. It is even possible that it could come from a different species.

The 2001 foot and mouth outbreak in England brought biosecurity to the forefront, but it should always be a concern because of the transmission of a multitude of diseases, the most common of which is calf scours.

There is not a standard biosecurity protocol for everyone. Depending on whether you are feeding cattle, running a cow-calf operation or raising a purebred herd, the controls are different. However, several cost-effective measures can be implemented.

Preventive measures include:

- not purchasing livestock from herds of unknown origin
- knowing who is visiting your farm and where they have been
- developing a policy with employees about how to deal with unknown visitors
- making sure visitors are not wearing soiled clothing
- posting clear signs indicating that all visitors must report in and sign a log book
- asking visitors specific questions about having contagious diseases on their premises and recent visits to other farms
- not allowing any visitors from a country with foot and mouth until at least 14 days after their arrival in Canada (including your staff and yourself)
- having a footbath with 50/50 water/vinegar disinfectant solution and having all visitors use it
  - make sure your boots and visitors' boots are scrubbed clean of organic material before and after visiting livestock on your farm
- having visitors use clean footwear or providing footwear for them
- cleaning and disinfecting all used equipment such as stock trailers and chutes
- not bringing meat or dairy products into Canada from another country, unless they are approved for herd processing
- handling healthy cattle first then treating diseased animals (minimizing contamination back to the main herd with diseases like scours)
- using a boot dip to disinfect footwear and changing coveralls when leaving isolated areas where there are sick animals
- cleaning and disinfecting all syringes and equipment used in the treatment of sick animals
- using a different esophageal feeder for scouring calves than the one used for providing colostrum to newborn calves
- keeping diseased animals isolated from other cattle, thus minimizing contact
- properly disposing of the manure and disinfecting or cleaning the pens where sick animals have been
- making sure that, when you are visiting other ranch operations, you use the same level of biosecurity on their premises to avoid bringing any diseases home
- checking with your veterinarian if there is any doubt about the spread of certain diseases and any precautions that might be necessary
- being careful because certain diseases can spread to humans
- cleaning up well and in certain circumstances using gloves when handling sick stock



# Summary

## Health Management Tips that Return the Greatest Profits

**Colostrum management** - Make sure all calves get enough good quality colostrum. Have a frozen source on hand.

**Calf scours prevention** - Have a vaccination program and management scheme in place to minimize losses from this deadly disease complex.

**Castration and implanting** - Castrate early and implant. The rate of return on implanting is at least 10 to one on every dollar invested. Heifers can be implanted once with most products. Check product directions for more information.

**Bull soundness exams** - The bull is half the genetic potential of the herd. Make sure bulls are fertile. Reproduction is the most important production trait in a cow-calf operation. Up to 20 per cent of bulls are sub-fertile in some herds. Statistics from 1998 show that only 50 per cent of producers test their bulls.

**Bull selection** - Use an easy calving bull, especially on heifers, to avoid calving problems and subsequent rebreeding problems.

**Pregnancy examinations** - This is important for identifying open cows so they can be shipped. Removal of open cows lowers winter feed costs. Historically, cow prices are higher in the late summer or early fall, increasing net return. Another benefit of culling is it shortens the calving season. Pregnancy exams may also identify reproductive problems. Almost half of all producers in Alberta are pregnancy checking their herds.

**Feed analysis and body condition scoring** - Most production-induced metabolic diseases result when the intake of a nutrient is suddenly reduced or is excessively high in the face of a continuing metabolic need. Feed analysis should be done in conjunction with condition scoring your cows at weaning. Condition scoring determines if cows need to gain weight or can afford to lose a little before the winter feeding period. Feed analysis allows you to balance the nutrients in the ration to meet the cow's need to gain or lose weight.

**Disease prevention** - Proper herd management is the key to a successful herd health program. Preventing disease can improve the production of the cow herd and reduce treatment costs.

**Maintain biosecurity** - Your vaccination program must be maintained as part of your overall biosecurity program. Work with your veterinarian to develop testing for new cattle purchases and monitoring visitors. Vaccinate for the main reproductive diseases, IBR and BVD. In 1998, only 40 per cent of producers vaccinated. However, vaccination compliance appears to be increasing every year. Reproductive losses are the greatest health cost to the beef producer.

**Autopsies** - Producers should have autopsies performed on most of the animals that die on the farm. The cause of death may identify management changes that need to be made. Peace of mind comes from knowing which deaths were unpreventable and those involving non-contagious agents.

Work closely with your local veterinarian to plan an overall health program that best suits your operation. Your veterinarian can help you implement any or all of the above-mentioned programs.





## Cattle Pests

# and Their Control

To have profitable cow-calf production, an effective pest control program is a must. Internal and external pests are encountered all year round in cattle operations. Each year, insects and other parasites take their toll on profits through reduced weight gains, decreased milk flow for the nursing calf, damage to hides and meat, disease transmission and even loss through death of infested animals.

This chapter describes the biology, impacts and control options for common external and internal pests of cattle. It also discusses pesticide products, formulations, application methods and safety.

## External Pests

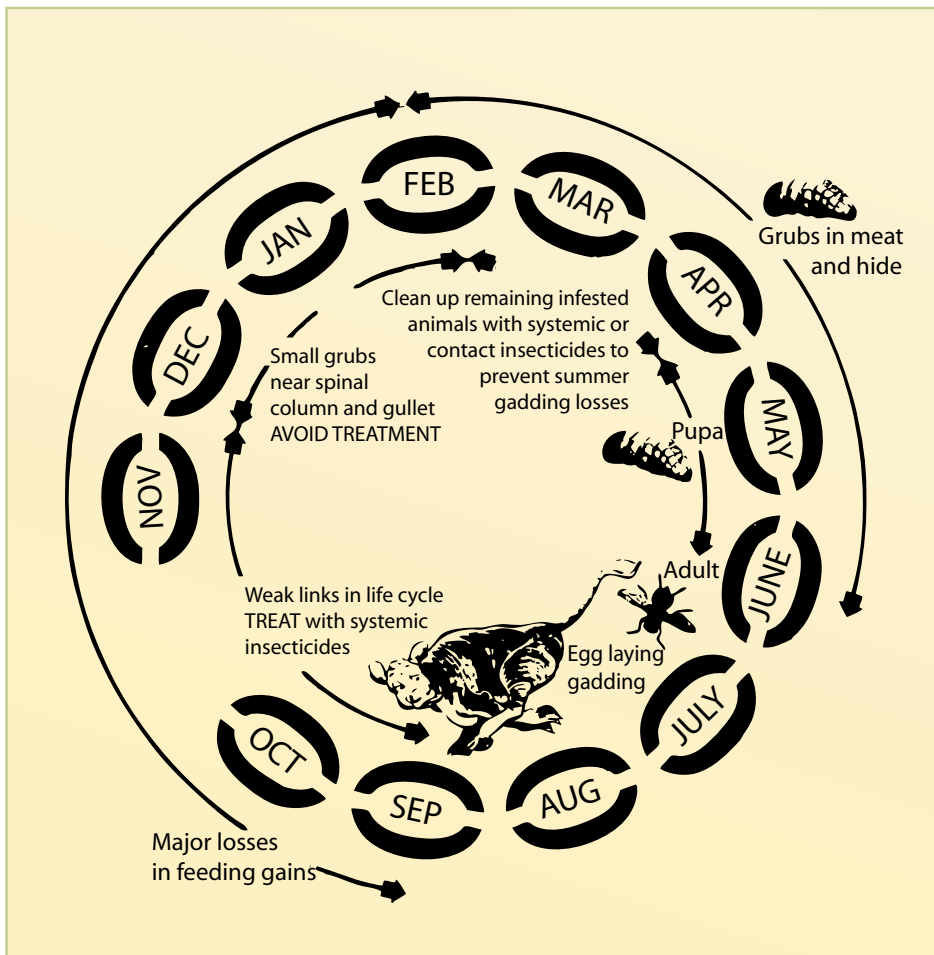
In Alberta, there are 10 major external pests of cattle: warble flies (cattle grubs), cattle lice, mange mites, black flies, horn flies, mosquitoes, houseflies, stable flies, face flies and horse flies. This section provides information to help producers recognize pest problems and to understand the biology, impacts and control of these pests.

### Warbles (Cattle Grubs, Warble Flies or Heel Flies)

#### Biology

Cattle are the only hosts of two species of cattle grubs: the common cattle grub and the northern cattle grub. They are generally referred to as warble flies, bomb flies or heel flies.

The life cycles of the two species are similar. The grubs, which appear in the backs of cattle in the spring, are familiar to almost everyone who handles



**FIGURE 61.** Life cycle of the warble fly

cattle. The grub-like larvae drop to the ground, pupate in the soil litter and emerge as adult flies. The adult flies, which resemble bees, are active in the spring and summer. They do not sting or feed on the animal. They simply mate and lay eggs on the hairs of the limbs or body of the animal, depending on the species of fly.

After only a few days, the eggs hatch and the tiny larvae immediately burrow into the skin of the animal. The larvae migrate for several months through the animal's body. The grubs reach the esophagus in the case of common cattle grubs, or the spinal canal in the case of northern grubs. The grubs stay at these locations for several weeks and then migrate to the back, directly beneath the hide. They form breathing holes to the outside at this stage and they are called warbles. This is where the hide damage occurs. After the larvae are fully grown in the warble cysts, they drop to the ground during the spring and begin their new annual life cycle (Figure 61).

## Types of Injury and Economic Loss

Warbles were a major economic pest to Alberta cattle. Due to monitoring at auction markets and imposing fines, the incidence and degree of infestation is now very low in Alberta. The inspections for warbles at auction markets were discontinued in 1988 because of the low incidence. However, if producers stop treating, the problems will come back.

Except for the pupa, every stage in the life cycle of the warble fly does some damage to the host animal. The northern species of the warble fly attacks and terrifies cattle during egg laying. The cattle react and run with their tails in the air to avoid the flies. This is referred to as gadding. Gadding causes physical injury to cattle when they run through fences and into other objects. It also results in reduced weight gains and milk

production. The weaning weights of calves may be reduced by 20 kg (44 lb.).

If over-wintering larvae are controlled in steers, they may gain an additional 0.1 kg (0.2 lb.) per day. Over a 180-day period, that can mean an extra 18 kg (40 lb.) per steer.

Warble grubs in slaughter cattle can cause considerable damage to carcasses and hides, resulting in discounts and downgrades. Trimming losses at slaughter can be up to about \$150 per head, according to the 1999 Canadian Beef Quality Audit. Trimming losses result from the bruising caused by larval migration in the muscle tissue. Time involved in trimming damaged carcasses is an indirect loss to the livestock industry. Producers can also suffer considerable economic losses from weight loss and hide damage caused by the warble larval migration through the body. As few as five warble holes in the back can reduce the hide value.



## Control

Applying systemic insecticides or broad-spectrum endectocides (chemicals that control insect pests and other parasites) in the fall to beef cattle and non-lactating dairy cattle can effectively control cattle grubs. The endectocides also deworm. Essentially, four groups of parasites (lice, worms, warbles and mange mites) can now be treated with one application of an endectocide. Insecticides and endectocides are available in spray, injectable, pour-on and spot-on formulations. More and more producers are now using the endectocides (especially the pour-ons) because of all the benefits realized with multiple parasite treatment. A treatment applied immediately after the first killing frost is more effective than a late treatment in November.

Always monitor cattle for several days after any pesticide application. Although rare, reactions can occur. Call your veterinarian about any adverse reaction.

## Cattle Lice

### Biology

Two types of lice are commonly found in Alberta: biting (or chewing) lice and sucking lice. Biting lice feed on outer layers of skin, scurf and dead tissue, while sucking lice feed on blood by piercing the skin.

Sucking lice are more common and suck blood by staying attached to the skin. They have very narrow mouthparts that allow them to do this. Biting lice have large mouthparts. They move around and also feed on surface debris. The chewing can cause intense itchiness and scratching in cattle. Patches of hair loss or hair that is wet from licking are common (Figure 62).



**FIGURE 62.** Signs of lice in cattle.

Sucking lice are visible to the naked eye as blue-like specks. They are commonly seen on the neck, around the eyes and around the udder or scrotum. In heavily infested stock, their white eggs may also be visible. The eggs are found stuck on the hair. Biting lice are just barely visible to the naked eye.

Cattle lice are specific to cattle and spread from one animal to the next through contact. They are permanently parasitic and spend their entire life cycle on the host. The egg, nymph and adult can all be found on the host animal. The female lice glue their eggs to the hair of cattle. The eggs hatch in one or two weeks. The newly hatched nymphs resemble the adult lice, except they are smaller. The nymphs mature into adults in two or three weeks. The adult can lay one or two eggs per day for about two weeks. The entire life cycle can be completed in one month. Lice occur on cattle all year round, but infestation becomes most noticeable and severe during winter and spring.

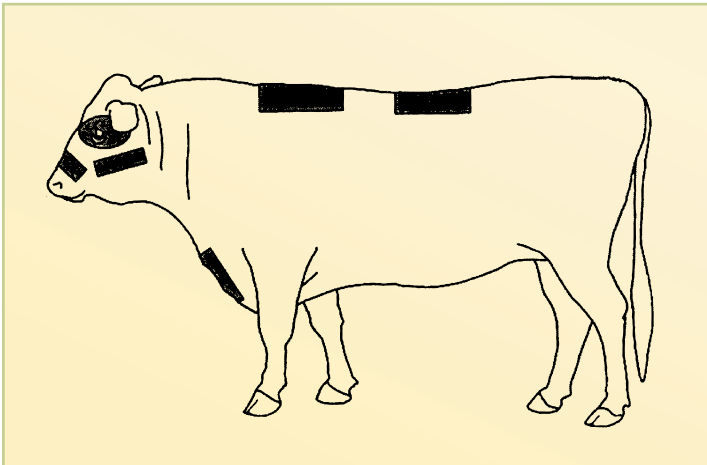
### Types of Injury and Economic Loss

Symptoms of louse infestation vary, ranging from excessive licking and scratching to hair loss. In extreme cases the result is anemia. Cattle that are heavily infested with sucking lice have bluish coloured patches around the face and brisket that result from excretions of digested blood by the lice. In severe cases the hair becomes rough, dirty, greasy and polluted with blood from crushed lice. The feeding activity of the lice irritates the skin and animals rub themselves trying to relieve the

itching. The constant rubbing of cattle irritated with biting lice results in open sores. These sores can also provide an entrance for other infectious agents. The irritation makes the animal nervous, edgy, go off feed and fail to gain at a normal rate.

Hair loss is a poor indicator of louse infestation. A wide variety of other organisms and conditions may lead to hair loss. Hair loss can also indicate ringworm (a fungal infection), mineral imbalances and allergic reactions.

Definitive diagnosis of louse infestation requires close examination of the skin surface. The examination should be conducted on restrained animals, held in a well-illuminated area. Several 10 to 15 cm (4 to 6 in.) long partings of the hair should be conducted at each of the sites indicated on the following diagram (Figure 63). The hair may have to be clipped and skin scrapings taken.



**FIGURE 63.** Areas to inspect for louse infestation  
Source: Colwell (2000)

Production losses from lice exceed \$30 million annually in the beef and dairy sectors, (Colwell 2000). Producers spend an additional \$8 to 10 million for treatments. Production losses result from blood loss, irritation and changes in behaviour, all of which reduce efficiency. Losses also occur from reductions in hide value from the response to sucking louse activity. Damage to facilities and equipment, resulting from scratching to relieve the skin irritation, is an additional cost.

Studies have shown that cattle treated for lice may gain an additional 0.05 to 0.54 kg (0.1 to 1.2 lb.) per day, depending on how severe the infestation has been.

## Control

An effective louse management program has four critical elements:

- adequate nutrition
- good husbandry, including provision of shelter and clean bedding
- genetics
- strategic treatment

Providing adequate shelter and bedding and applying strategic treatments are the two elements that are most applicable to beef cows:

- Provision of adequate bedding and shelter to keep animals clean and dry reduces stress on cattle. The additional drain on energy associated with keeping warm and the impact of stress on immunity can combine to make animals more susceptible to louse infestation. Clean, stress-free animals actively groom themselves, frequently licking most parts of their bodies. This behaviour is an effective way for animals to reduce louse populations.
- The application of an effective treatment is crucial to reduce and manage louse populations. However, it is unlikely that louse management is the only objective of most treatment programs. It is important to approach the management of lice as part of a complete parasite management program and to make treatment decisions accordingly. Thus, as much as possible timing of treatment should coincide with the management of cattle to control grubs and worms.
- The application of treatments should be timed to fit the biology of lice and to prevent population buildup. Thus, treatments should be applied in fall or early winter prior to the population peaks, in January. Delaying

treatment as long as is consistent with other management practices reduces the risk of louse populations rebuilding if new, infested animals enter the herd.

- The duration of activity of a product is crucial to assessing the need for retreatment. The hatching of eggs after adults have been killed means that the product must be effective long enough to kill nymphs hatching from the last eggs laid. Since egg development slows at lower temperatures, the product's activity must extend beyond the longest possible development time. Extremely cold winter temperatures can impact the effectiveness of various products.

To prevent the buildup of a heavy infestation in a herd, check animals early in the fall for signs of lice. It is particularly important to spot a carrier animal that becomes habitually lousy each year. These animals are a source of infestation to the entire herd and should be eliminated as quickly as possible. Because lice prefer cooler weather, the fall or spring is when the populations rapidly increase. Lice are ideally suited to Alberta weather.

In severe cases, where cattle become anemic and weak from blood loss, iron and blood supplements are needed. If any cattle are diagnosed with a louse infestation, it is likely the entire herd is infested to a greater or lesser degree and should be treated.

Treating cattle with endectocides has the added benefit of killing sucking lice. These products also last long enough to kill the eggs as they hatch, thus ensuring an almost 100 per cent kill. Biting lice are harder to kill because they don't feed continually. Pour-on insecticides are considered more effective on biting lice. The products licensed for treating warbles are also effective against lice, but do not last as long as the endectocides. Treatment at pasture is effective with the continual use of oilers or dust bags.

A preventive treatment early in the fall, using a pour-on or insecticide or endectocide, effectively controls the population of lice that occurs during this time. This is usually done at the same time as cattle are treated with a systemic insecticide for

the control of cattle grubs. As noted, the injectable endectocides will kill sucking lice, as well as cattle grubs, but not biting lice. Producers should consult with their veterinarian prior to treatment. Consideration also needs to be given to withdrawal periods when choosing which treatment to use.

A second treatment before the onset of cold weather ensures protection from a severe infestation. Self-treatment devices such as dust bags, oilers and backrubbers eliminate the work of applying insecticide. Concentrated pour-on and dust can be applied to individual animals.

## Mange

### Biology

Mange is a contagious skin disease caused by four species of very tiny mites that live on or in the skin of cattle. The infection spreads among cattle when they are in close enough contact for mites or mite eggs to move from one animal to another. Mange may also be transmitted via bedding, buildings and feeders. Infection is seen mostly in winter when animals are in close contact. As with lice, mites prefer cooler weather. Although animals of all ages can be affected, for unknown reasons herd bulls are usually the first to exhibit signs.

Of the four types of mange that occur in cattle, only chorioptic and sarcoptic mange are seen in Canada. Mange caused by either of the other two species, *Soroptes* and *Demodex*, is rarely seen.

### Types of Injury and Economic Loss

Chorioptic mange, often known as leg mange, is most common around the feet, legs, tail head and axillary (arm pit). It produces intense irritation with weeping scabs and self-inflicted injury.

Sarcoptic mange, or barn itch, is caused by the parasitic mite *Sarcoptes scabie var bovis*. Mange produced by this mite can be severe because the mite burrows deeply into the skin, causing intense itching. Cattle affected by sarcoptic mange lose grazing time and do not gain weight as rapidly as do uninfected cattle.

The feeding and burrowing activities of mites produce an intense irritation. Affected animals rub against posts, trees and feeder bunks to relieve the irritation. This rubbing can result in localized or widespread hair loss.

When cattle rub to the point of bleeding, the injury to the skin produces a fluid called exudate. The exudate hardens and forms a crust, which produces the condition known as scab or scabies. When this situation occurs:

- scabs can appear on the inner surface of the thighs, the underside of the neck and brisket, and around the tail head
- lesions can become widespread in advanced cases
- skin thickens and takes on an elephant-skin appearance

The speed at which an infestation spreads over an animal depends on several factors:

- number of mites transmitted
- site of the infestation
- susceptibility of the host

Visible lesions on cattle heavily infested with mites may appear in 10 to 14 days.

The skin damage associated with mange is different from that caused by lice. However, mange can be confused with lice infestation.

Consultation with a veterinarian may be necessary because the mites are too small to be seen with the naked eye. A positive diagnosis of mange is only possible by using a microscope to examine tissue from a deep scraping of the lesions.

Because mange is potentially a serious disease, all suspected cases must be reported to the Canadian Food Inspection Agency (CFIA).

## Control

Several drugs have proven very effective in treating mange. These are the same pour-on and injectable insecticides and endectocides that are used to treat for lice and internal parasites. Treating with endectocides in the fall keeps all parasites,

including mange mites, under control. In fact, the introduction of these new endectocides has made the diagnosis of mange a rare event on the Prairies. Contact a veterinarian to confirm the presence of mange and then get his/her advice on the most suitable treatment program.

Several strategies are available to prevent cattle from getting mange and scabies:

- clean stalls used to house infected cattle and add fresh bedding before reusing stalls for new animals
- disinfect grooming tools and other instruments used on infected animals
- isolate infected animals from the rest of the herd and then treat them
- examine replacement cattle for mites before putting them with the rest of the herd
- avoid overcrowding
- ensure animals are well-nourished as cattle in poor condition are more susceptible to infection than healthy, well-fed animals

## Black Flies

### Biology



**FIGURE 64.** Adult black fly  
Coutesy: R.V. Peterson, Diptera Unit,  
National Museum, Washington, D.C.

There are over a 100 named species of black flies [*Simuliidae* (S.)] in Canada, and there are more that have not even been named. However, only a small fraction of the species now recorded in Canada are pest species (Figure 64). In Alberta, *S. arcticum* and *S. luggeri* are serious pests of livestock.

Black flies are among the smallest of the biting flies that attack cattle. Adult females feed on blood, causing irritation and discomfort to humans,



domestic and wild mammals, and birds. They are sometimes referred to as sand flies or as buffalo gnats because of their humped back.

There are four stages in the life cycle of this fly. The first three stages – egg, larva and pupa – are found in running water. The eggs are laid by the female black fly on or in the water. The larvae remain attached to substrates such as rocks and submerged vegetation. They obtain food through a method called filter feeding. The larva is transformed into a pupa and remains attached to the substrate until it emerges as an adult fly. The adult flies feed on animal blood and plant juices. The females, when searching for a host, move in swarms to attack cattle and other livestock. The duration of each stage in the life cycle and the number of generations during the summer months vary with the species. In the boreal forest, they may be present throughout June and July.

### Types of Injury and Economic Loss

Black flies are attracted to host animals in swarms. As they fly about, they often get into the nostrils and mouth of the host. If they are inhaled, they form a ball of mucous-coated flies, which may mechanically choke or suffocate the animal. They either feed on exposed areas of skin around the eyes, ears, nose and mouth, or they crawl into the hair coat to feed. The bites cause severe itching, swelling and irritation that lasts for several days. Naive cattle (not previously exposed) have died following a heavy attack by black flies in Alberta. Cattle deaths result from suffocation and anaphylactic shock. Significant losses from reduced weight gain and reduced milk production have been reported during black fly activity. The weaning weights of calves can be affected due to damaged udders. In bulls, numerous bites on the scrotum and sheath can reduce the ability to breed.

### Control

Livestock can be protected from black fly attack by raising animals as far away as possible from black fly breeding grounds, providing shelters so animals can enter and avoid attack during



*A relatively simple shelter can protect cattle from black flies.*



periods of intense activity, treating animals with insecticides or repellents, and implementing a larviciding program.

During severe black fly attacks, cattle seek shelter in bush or semi-dark buildings, when available. Shelters that feature dark conditions provide relief to cattle, as black flies will not fly into them. Structures consisting of three solid walls and a roof are usually adequate. For example, a shelter 6 m (19 ft.) wide, 12 m (39 ft.) deep (front to back) and 2.5 m (8 ft.) high, with two solid sides, one end wall and a roof is adequate for 20 mature cattle. Cattle learn quickly to use the shelters.

Insecticide treatments must cover most of the animal's body to be effective. Only use repellents and insecticides that are specifically recommended for black flies. Follow the label instructions carefully. Withdrawal times and restrictions on use before slaughter must be followed.

An electrostatic sprayer allows efficient application of repellents or insecticides to cattle under pasture conditions. The insecticide or repellent solution is dispersed as charged droplets that are attracted to the hair of the animals. The advantages of this sprayer are that the animals need not be restrained or penned to achieve total body coverage, small amounts of spray solution are required and little time is needed to treat the animals.

Backrubbers (Figure 68) charged with insecticides or repellents provide protection from black flies, with minimum handling of animals. Free-use applicators can be placed in pasture or yard locations, where animals have convenient access to them whenever they want to use them. Forced-use applicators are installed in entrances to fenced-in mineral, or water sources or shelters so the animals receive a repellent or insecticide treatment every time they enter and leave the



*Horn flies rest on the back and shoulders and feed on the underbelly and udder.*

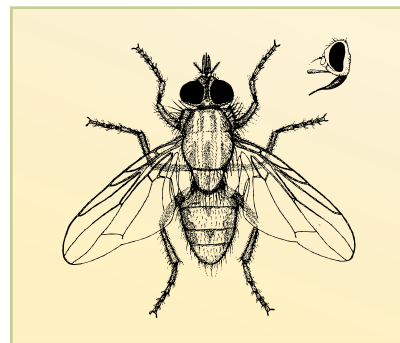
## Horn Flies

### Biology

Horn flies are small, dark grey flies that are about half the size of a housefly or stable fly (Figure 65). They are easily recognized as they rest on animals with their heads facing downwards. They congregate in clusters and always prefer the side of the animal that is in the shade. Unlike other biting flies, they live on the host animal. These flies consume five

times their weight in blood at each feeding, up to 38 times a day. After persistently feeding day and night, they leave the host animal only long enough to lay eggs in freshly dropped manure.

The female flies lay reddish-brown eggs in the manure and immediately return to the cattle. When the larvae hatch from the eggs and complete their development, they migrate down to the soil and are transformed into barrel-shaped dark pupae. Within a few days, adult flies emerge. Succeeding generations follow each other through the season.



**FIGURE 65.** Horn fly

Courtesy: R.V. Peterson, Diptera Unit, National Museum, Washington, D.C.

Horn flies overwinter as larvae and pupae.

The horn fly life cycle is very short, just 14 days. Therefore, as many as five generations may be produced in a single season.

enclosure. Forced-use application is usually more effective than the free-use method. Installing these self-administered devices at the entrance of the shelter has proven very effective.

Eradication of black flies over large areas is not feasible. However, focusing on larval breeding sites along sections of rivers and streams that can potentially produce outbreak populations can provide good control. Water level manipulations or larvicide applications at the correct time of the life cycle can substantially reduce the populations. At known breeding sites, a carefully calculated concentration of larvicide injected into the water can kill larvae and reduce black fly numbers.

A larval control program should aim to kill the greatest number of larvae possible with a single application of larvicide. Once the larval habitat of the pest species is determined, cost-effective control can be implemented when high numbers of larvae accumulate.

Small-scale larvicide programs involve the application of either undiluted or diluted insecticide from a boat. A variety of techniques including tank, barrels, backpack sprayers, or a watering can, may be used depending on the amount required and the type of stream.

Consult pest control personnel who have experience with in monitoring larval populations when a larvicide program is being considered. They know the techniques needed to develop an effective program.

A permit from Alberta Environment is required when insecticides are applied to flowing water. Application forms can be obtained from any Alberta Environment office or downloaded from <http://www3.gov.ab.ca/env/protenf/pesticide/index.html>.

### Types of Injury and Economic Loss

Horn flies are the worst biting species that affect cattle. Their numbers peak in July and August in most parts of Alberta. Horn flies are blood feeders and in heavily infested herds, as many as 3,000 to 4,000 flies can be found resting and feeding on a single bull. Cows and steers can carry 300 to 400 flies per head and up to 1,500 can be found on cows by mid-August. Horn flies are more attracted to bulls than cows. Calves are not attacked until they reach puberty (around six months of age).

Both male and female flies have beaks that they use to obtain blood meals. Studies conducted at the Lethbridge Research Station indicate that 40 or more flies per animal warrants immediate control measures due to the lower performance and productivity of the animal. Horn flies and face flies drastically reduce weight gains on grazing cattle.

## Control

Horn flies are one of the easiest pests to control because they remain on the animal day and night. To be effective, any fly control program should achieve 95 per cent effectiveness control rates or better. Watch the flies on bulls to determine if insecticide resistance is developing.

Several insecticides and application methods are available for combating horn flies:

**Self-treatment devices** - Providing access to self-treatment devices such as backrubbers and dust bags is effective. Installing these devices near a water source or a salt lick that cattle visit once or twice during the day is most effective. Dust bags and oilers provide good control as long as they are maintained and replenished with approved insecticides.

**Ear tags** - Insecticide ear tags revolutionized fly control when they were introduced in the 1980s. The tags provide good control for approximately 90 days. If one tag is put in each cow-calf pair, effective control is gained on both animals. Placing the tag on the cow is the better choice, as flies are most attracted to mature stock. To reap the maximum benefit throughout the summer, the fly tags should be applied just before the cattle are turned out. Remember that once an insecticide tag is placed in an ear, it starts dispensing chemical as the animal bends its head back to lick or rub its shoulder. Flies develop insecticide resistance quickly so it is best to check with your veterinarian about which tag is the most effective.

**Pour-ons** - More recently, a pour-on product has been developed which lasts approximately 60 days. Ivomec®, a pour-on endectocide, also has label approval for controlling horn flies for five weeks. This is an added benefit to treating at turnout.

## Horn Fly Insecticide Resistance Management

The appearance of horn flies on cattle treated with ear tags or exposed to backrubbers is a good indication that the horn flies have developed insecticide resistance to the product in use. To date in Canada, only horn fly resistance to synthetic pyrethroids has been confirmed. However, resistance to any insecticide can be expected under intensified-use programs. In the case of synthetic pyrethroid-impregnated ear tags, insecticide resistance developed after years of successive use. If a horn fly population develops resistance to one synthetic pyrethroid, it is resistant to all of them. Once established, resistance persists for a number of years.

When possible producers should alternate in successive years among synthetic pyrethroid, carbamate and organochlorine insecticides. Check the label for the active ingredient as different brands of tags may contain the same active ingredient. You can save money by comparison shopping and at the same time avoid inadvertently using the same active ingredient in successive years. Alternating the mode of action helps prevent pests from developing resistance to any one of the classes of insecticides and prolong their effectiveness. However, the ability to alternate between insecticide classes may be limited due to the type of cattle or compatibility of the treatment method with the herd management system.

Producers who suspect insecticide resistance in their herds should contact their insecticide supplier or Alberta Agriculture and Food's Ag-Info Call Centre [phone: 310-FARM (3276)] to get advice on alternative controls. Further treatments with the insecticide should be stopped. To reduce the number of resistant flies that reproduce in the overwintering generation, treat the cattle before the end of the fly season with another class of insecticide. The following year, use the same class of insecticide used at the end of the previous summer.

## Mosquitoes

### Biology

There are about 35 different species of mosquito in Alberta. Mosquitoes require water to complete their life cycle. The four stages of the life cycle are egg, larva, pupa and adult. The eggs are laid on or near water. When there is contact with water, the eggs hatch and produce larvae or wrigglers. These can be found in standing water in both pastures and roadside ditches. The larva is transformed into a comma-shaped pupa called a tumbler. It swims to shore and in a few days an adult mosquito emerges from the pupa.

Female mosquitoes are blood feeders, while males feed on plant juices. In most of the species there is only one generation per season. However, all the eggs do not hatch at one time and successive flooding of the pools may produce several broods during the season. Some species of mosquito over-winter as adults and others over-winter in the egg stage.

Of all the mosquito genera, *Aedes* (A.) or floodwater mosquitoes are the most serious pest of cattle. Most species belonging to the *Aedes* genus hatch in early spring from over-wintering eggs. These early hatching species account for the surge in mosquito numbers as soon as the leaves appear on trees.

### Types of Injury and Economic Loss

Female mosquitoes require a blood meal before laying their eggs. Severe attacks on cattle occur in the early morning and early evening hours. During mosquito attacks, cattle exhibit behavioural changes, such as stampeding, bunching together on higher ground and licking each other to get relief from the bites.

The losses resulting from mosquito attacks and the behaviour of cattle being bothered by mosquitoes are considerable. In affected areas, a drop in milk production has been noted in lactating cows, resulting in a lower rate of gain for calves. The loss of blood can result in poor weight

gains and loss of condition for both the cow and the calf. In extreme cases, the death of small calves has been attributed to worry and the loss of blood.

### Control

All mosquitoes require water for the immature stages to develop. Eliminating standing water, such as rain-filled ditches, ponds and shallow pools from spring snowmelt, greatly reduces the mosquito population.

Protecting cattle from mosquito attacks is possible through frequent application of fast-acting insecticides or insect repellent combinations. This can only be achieved if cattle can be handled frequently or if they have access to self-treatment oilers.

Organizing an area control program through the local municipality is another way to reduce the losses caused by mosquitoes.

## Houseflies

### Biology

A common pest that is well known to everyone is the housefly. The housefly is a greyish color with four dark thoracic stripes. The annoying habits of the housefly, along with its ability to carry disease, make it a public health concern. The housefly is closely associated with human activity and it uses a variety of forms of organic matter for breeding and feeding purposes. Livestock buildings and feedlots have an abundance of organic waste that is suitable for housefly multiplication.

The housefly has four stages in its life cycle: egg, larva, pupa and adult. The eggs are laid in manure, rotting bedding or silage pits. There, the larvae hatch and pupate. The entire life cycle is completed in two weeks. Houseflies over-winter as adults in farm buildings.

### Types of Injury and Economic Loss

The role of the housefly as a carrier of livestock diseases has not been extensively studied. It is suspected that flies transmit many diseases because they have ready access to the feces and wounds of infected animals.



Houseflies worry livestock with their persistent attention and are responsible for loss of condition. Cattle often suffer with inflammation of the eyes during fly season. This condition can be spread through a herd, from one animal to another, by flies.

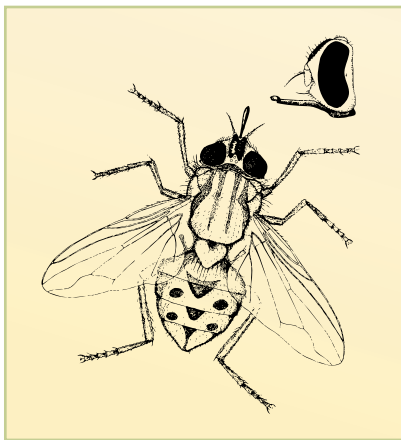
## Control

Eliminating the breeding sources through proper sanitary procedures can reduce fly infestations. A weekly schedule for cleaning up and disposing of spilled feed along feed bunks, in the silage pit and in other areas helps reduce the areas available to flies to lay their eggs in. It also helps to keep the pens clean and dry, and to collect and spread cattle manure on a weekly basis during fly season.

Other control methods include using residual wall sprays containing insecticides, flypaper and poisoned baits.

## Stable Flies

### Biology



**FIGURE 66.** The adult stable fly is about 6 mm (0.2 inches) long

Courtesy: R.V. Peterson, Diptera Unit, National Museum, Washington, D.C.

The stable fly, also called the biting housefly or dog fly, resembles the housefly. It is a brownish grey colour but the outer four thoracic stripes are broken. The abdomen has a checkered appearance. The stable fly has a pointed beak that points forward from beneath the fly's face when it is at rest (Figure 66).

These flies rest on the sunny side of the walls of stables or other farm buildings, with their faces pointing upwards, away from the ground.

Stable flies are not host-specific and will attack cattle, pigs, horses, dogs and even humans.

The life cycle and early stages of the stable fly are similar to those of the housefly. The entire life cycle is completed in 24 days. Stable flies can produce several generations per season. Wet feed or hay contaminated with manure, urine and mud are particularly good media for development of the stable fly. Sometimes, decaying weeds along a lakeshore or rotten lawn clippings are also breeding grounds for these flies.

## Types of Injury and Economic Loss

Both male and female stable flies bite cattle, most often on the legs. When these flies are numerous, cattle do not get any rest from daylight until dark. They continually stamp their feet and twitch their bodies. The bites are painful because the flies pierce the skin with their beak and suck blood.

Research shows that stable flies affect weight gains in feeder cattle and reduce milk production in dairy cattle.

## Control

Eliminating sources of stable fly breeding is the least expensive and most effective method of control, yet this is generally ignored. The accumulation of larval sustaining materials is often found to be responsible for a stable fly outbreak. These materials can include manure, old hay and straw in stacks around feedlots and farm buildings.

Spraying the outside of farm buildings, where flies tend to rest, also helps to control stable flies. A light spray of a 0.9 per cent dichlorvos solution can be used to keep stable flies off cattle. This is applied to the legs and lower part of the body on a daily basis, at the rate of 30 to 60 mL per head.

## Face Flies

### Biology



**FIGURE 67.** Face fly

Courtesy: R.V. Peterson, Diptera Unit, National Museum, Washington, D.C.

The face fly is an important, non-biting fly that affects cattle. It resembles a housefly, but it is slightly larger and darker in colour (Figure 67). Also, face fly pupae are white,

while housefly pupae are brown. Upon close examination the housefly and face fly can be distinguished by differences in the compound eye.

The life cycle of face flies is similar to that of houseflies. Eggs, larvae and pupae can be found in cattle droppings in the pasture. The adult face fly is about 8 mm (0.3 in.) long. Because of a short life cycle, many face fly generations can be produced in a single season. They over-winter as adults in animal shelters, under loose tree bark and in other protected places.

Face flies are active during daylight hours, especially on calm, bright, warm summer days. They prefer natural light and avoid darkened buildings and windy regions. They are strong fliers and can travel several kilometres.

### Types of Injury and Economic Loss

Face flies have an annoying habit of landing on the face and probing eyes and nostrils. They feed on the mucous secretions and tears produced by persistent probing of the eyes. During heavy infestations, cattle huddle close together trying to brush the pests away with their tails. This results in loss of grazing and reduced weight gains.

In areas where face flies are abundant, pinkeye and a condition caused by physical abrasion of the eye are often reported. Face flies may also play a role in disease transmission. Fifty or more flies per animal are considered abundant and can cause economic loss through loss of condition.

### Control

Face flies do not enter darkened barns and stables. Show animals can be protected by keeping them indoors. Self-treatment devices such as oilers can be equipped with face fly mops. Dust bags installed in the loafing areas may provide effective control. Insecticide-impregnated ear tags are also effective.

## Horse Flies

### Biology

Many species of horse flies attack cattle, horses, mules, hogs, dogs, deer and other mammals, including humans. Adult horse flies are large, about 20 to 25 mm (0.75 to 1.0 inches) in length. They are sometimes referred to as bulldogs.

Only one generation of horse flies is produced each year, usually for three to four weeks in August. Eggs are laid on the stems and leaves of aquatic plants, located in wetland areas. The larvae are carnivorous and feed on mosquito larvae and other aquatic insects. The larvae migrate to damp soil. They pupate in decaying organic matter near the shore of a pond. The pupae hibernate over the winter. The adult horse flies emerge from the pupae in late June and early July.

The adult horse flies are strong fliers that can move in from some distance away to attack animals. Horse flies like the shade and attack cattle resting in the shade.

### Types of Injury and Economic Loss

The female flies are intermittent feeders that are active during the day. The flies attack and feed on blood from the animal. Their bite, which is

extremely painful, causes considerable bleeding. Their bites generally elicit a response (movement) from the victim so the fly is forced to move to another spot or victim. A peculiar habit of the flies is that they bite several times before they feed. A large number of flies are often attracted to the blood pool.

The painful bite and buzzing sound the flies make while flying around animals may cause the cattle to stop grazing and cluster together for protection. This behaviour causes weight loss and reduced milk flow. Weight loss estimates have been as high as 45 kg (100 lb.) per animal during the season and estimates of reduced milk flow have been 20 to 30 per cent. The clustered animals often injure each other by kicking or hooking each other with their horns.

## Control

It is difficult to control horse flies at the breeding sites, as they are located in environmentally sensitive wetlands. Also, breeding sites may be very extensive or some distance away from where problems are occurring because these insects can fly long distances.

Frequently applying chemical repellents during the summer or keeping the animals indoors when flies are active on hot summer days can protect cattle. Unfortunately, neither of these methods is practical for most beef herds when they are grazing pastures.

Several factors have been suggested to explain the difficulties of controlling horse flies in the pasture or range situation. These include:

- the relatively large size of the horse fly increases the dose of insecticide necessary to produce death
- the brief feeding period on the animal means that the flies are not in contact with the insecticide long enough to be killed
- the insecticides used in self-treatment devices are very irritating to the flies and cause them to leave almost immediately after landing

Horse flies swarm persistently around animals and feed where the spray coverage was not complete (underbelly or legs) or where it has worn off. Fortunately, horse flies are sporadic problems for specific times of the year.

## Internal Pests

### Gutworms

#### Biology

Gutworms (*Strongyles*) are associated with acute or chronic diseases. Animals ingest the larvae (immature parasites) with their food (usually pasture grass). Once an animal eats them, these larvae migrate into the lining of the gut and then return to the cavity of the gut where they become adults. Under ideal conditions the whole cycle, adult to adult, takes about one month. Gutworm eggs are excreted in the infected animal's manure. The eggs require moist, dark conditions.

#### Types of Injury and Economic Loss

Gutworms generally cause hidden losses, such as decreased weight gain. Many infected animals show no obvious abnormalities. Affected animals show depressed production, a loss of condition and in some cases a lack of appetite. Scouring, dehydration, anemia or edema is usually only seen in acute cases. The effects are most important in young animals on pasture. However, they may also be seen in adult cattle, as well as housed and feedlot animals.

Several species of gutworms affect cattle and some cause greater harm than others. Tapeworms, a type of gutworm, are rarely seen and are not considered significant unless found in very high numbers.

## Control

Many anthelmintics (wormers) are effective against the adult parasites, as well as the larval and encysted forms in the gut. Many good pour-on and injectable products have been developed to treat both the adult and larval forms. These products include Ivomec®, Dectomax® and Cydectin®. These products are also used to treat for lice and warbles at the same time. Supportive treatment, in the form of good nutrition and adequate shelter, is important for severely affected animals.

Most cattle in Alberta are treated yearly (fall) for internal parasites. This keeps the gutworm levels low. By treating cattle before there is a problem, infestations are eliminated and weight gains are improved. Treating calves on entry into their summer pastures has improved gains by 11 kg (25 lb.) over the summer.

Control measures vary from farm to farm. Consult a veterinarian. Routinely have your veterinarian perform fecal exams to check the success of your deworming strategy. Most veterinarians use a level of greater than 25 eggs per gram of manure as being significant. With this level, clinical signs are not evident.

Several preventive measures can be implemented. Avoid overcrowding animals of mixed ages on areas where there is inadequate grass because older animals are the main source of infection for young stock. Rotational grazing and harrowing pastures prevents re-exposure because the manure piles are broken up. Exposure to sunlight and drying kills the eggs in the manure.

## Lungworm

### Biology

Lungworm is an acute or chronic infectious disease caused by the parasite *Dictyocaulus viviparus*. Animals acquire the infection as larvae (immature parasites) taken in with their food, usually from pasture grass. Wet weather and field conditions allow the larvae to hatch most prolifically. The larvae are shed in the manure of infected cattle. Once an animal eats them, the larvae migrate through the lungs. Adult worms then live in airways.

This condition often appears on a farm year after year, especially if there are sloughs or low areas in the pastures. The larvae can over-winter on pasture in Alberta.

### Types of Injury and Economic Loss

This disease is usually seen in young stock, towards the end of their first season on grass. Many infected animals show no obvious abnormalities. Clinical signs include a persistent cough, difficult breathing, poor feed consumption, loss of condition or scouring in the early stages. A common scenario is for many animals to have poorly bleached hair coats. There may also be a fever, if a secondary infection caused by bacteria or viruses develops. Persistent infection may cause a pneumonia condition that can become critical to the animal's health. Some animals may die from lungworm infection. When your veterinarian performs an autopsy, the adult worms are relatively easy to see in the windpipes of dead animals.

### Control

Some anthelmintics kill both immature and adult parasites. Treat all animals in the affected group. Affected animals may require antibiotics if there is substantial lung damage from the pneumonia.

Older animals are the main source of infection for young stock. Therefore, if possible, the two age groups should not be put on the same pasture.



In problem pastures, producers should deworm at turnout and again in midsummer. A product called Safe-Guard® (fenbendazole) can be used in grain or crumble, or mixed in midsummer minerals. This needs to be prescribed by a veterinarian, but is advisable in pastures with prior history of lungworm infections.

If you see coughing, unthrifty calves at pasture, then a complicated fecal exam (baerman) to specifically check for this parasite is recommended. Although this takes several hours, most veterinary clinics have the equipment necessary to perform the exam.

When treating clinical cases, watch closely as the clinical signs actually worsen before they improve. This happens because the killed worms must be coughed up and some individuals develop allergic pneumonias. Some cases may need antibiotics to counteract this.

## Parasiticide and Insecticide Products

Products for controlling external and internal livestock pests can be grouped into two major classes. They are:

- parasiticides including anthelmintics and endectocides
- insecticides including systemic and contact insecticides from several chemical families

### Parasiticides

Parasiticides are drugs or chemicals that kill parasites of cattle. Examples of the classes of parasiticides and the parasite they control are: anthelmintics for worm treatment (e.g. Safe-Guard®) and endectocides, such as ivermectin products, for killing internal worms and external parasites.

### Anthelmintics

Anthelmintics are drugs that are used to control nematodes (worms) in horses, dogs and cattle. The ideal anthelmintic agent should:

- be easy to administer
- have a broad spectrum of activity against mature and immature larvae
- be compatible with other compounds
- not leave a residue(s) requiring a long withdrawal period
- be economical to use

Anthelmintics can be administered in a variety of ways. Drenching, paste and injectable preparations allow a greater degree of control over the amount that is administered to an individual animal over when the drug is given in feed or medicated block preparations.

### Endectocides

Endectocides are a newer group of parasiticides that are active against a wide spectrum of external insects and mites, and internal parasites. They are used in the treatment and control of internal (endo-) and external (ecto-) parasites in certain animals. Due to their broad spectrum of activity, it is possible to treat several species of parasites with one dose of endectocide. Examples of insects and parasites controlled by endectocides are lungworm, warbles, horn flies, mites and lice. Moxidectin (Cydectin®), ivermectin (Ivomec®) and doramectin (Dectomax®) are examples of registered endectocides available for parasite/insect control in Canada. Depending on the active ingredient and registered label use, these endectocides can be applied to the skin (topically), injected or given in a bolus form (orally).

## Insecticides

The insecticides used on livestock to control arthropod pests (e.g. insects and spiders) are specialized chemicals with low vertebrate toxicity and very high toxicity to insects and related groups of animals. These insecticides are classified as either systemic or contact insecticides.

### Systemic Insecticides

Regardless of how these products are administered to the host, these compounds are absorbed into the blood system of the host and then ingested by the parasites living in or on the host's body. Organophosphorus compounds, such as coumaphos, fenthion, phosmet and trichlorfon, are systemic insecticides. They are applied to the skin for controlling cattle grubs that are lodged inside the animal's body.

### Contact Insecticides

These compounds are toxic only when brought in direct contact with the parasite. They are applied directly to the parasites living on the body of the host. Rotenone and malathion are examples of contact insecticides.

## Formulations

Several different kinds of formulations are available for insecticides and parasiticides. Some are ready-to-use directly from the container. Others require diluting and mixing before application.

### Injectable

This is a formulation in which the active ingredient (e.g. ivermectin) is injected into the animal with a needle and syringe. Then the active ingredient is absorbed into the bloodstream. These formulations are used to kill internal worms and external parasites. While injectable parasiticides continue to be used, oral and topical routes of administration are more common.

### Wettable Powder (WP)

This is a formulation in which the active ingredient is absorbed on a carrier material that is wettable in water. The formulation, when mixed with water, forms a suspension rather than a solution. Unless constantly agitated, the material will settle out. The formulation is applied as a spray. Pumps that are not thoroughly flushed out with water after using wettable powders may be damaged or clogged. Follow the label instructions carefully when mixing and using wettable powders. This helps avoid spraying difficulties and equipment problems.

### Dusts

Dusts are usually specially prepared formulations for dry application. The active ingredient is diluted to a low concentration with an inert dust. The formulation is then applied directly to the animal's skin.

Wettable powder formulations should not be used as dusts. The rate of absorption of the active ingredient by the skin is usually greater for a wettable powder than it is for a dust preparation with an equal concentration of the active ingredient.

### Emulsion, Emulsible Concentrate (EC)

An emulsion is a liquid concentrate that contains emulsifiers to keep the active ingredient in uniform concentration in a tank. Less stirring of the mixture is required as compared to wettable powders. The emulsion is sprayed onto the animal's skin.

## Application Methods

It is important for producers to become familiar with the commonly used insecticide and parasiticide application techniques and terminology. Most insecticide and parasiticide containers include specific information about the product, its uses, and proper mixing and handling techniques. Read and follow the instructions on the label. This is important for your protection, your cattle and the environment. In particular,

be sure to read the manufacturer's instructions regarding the following use information:

- the types of worms (e.g. nematodes), insects or other pests against which the chemical is active
- the class of animal host for which the product is recommended
- any limitations to its use
- dose rate and any difference in dose rate that may be used to deal with different developmental stages of different species or types of pest
- recommended method of application
- withdrawal period (in food-producing animals)

## Injection

Give all intramuscular (in the muscle) and subcutaneous (under the skin) injections in the neck. Do not give injections in the rump or thigh, as these are expensive cuts of meat and injection site lesions create significant muscle damage, scarring and tough beef. If the label indicates that the product can be given either subcutaneously or intramuscularly, then give it subcutaneously to reduce the risk of tissue damage. If possible, use products that can be given by routes other than by injection (e.g. pour-on). (Refer to the *Injections* section in the *Animal Health Management* chapter for proper injection techniques.)

## Livestock Spray

Diluted liquid insecticides are applied by means of high-pressure spray. The pressure should be about 2,400 kilopascals (kPa) [350 pounds per square inch (psi)]. This is important because wetting the skin is necessary to achieve thorough coverage of the cattle. Seven to 14 L (1.5 to 3 gal.) of spray per cow or 5 to 7 L (1.1 to 1.5 gal.) per calf may be required.

## Mist Spray

A hand-operated electric sprayer (mister) is used for applying small quantities of concentrated insecticides. The sprayer delivers a coarse spray to cover the hair coat of the animal. Mist applicators can also be used for spraying small, enclosed areas.

## Residual Wall Spray

A very low pressure of 550 kPa (80 psi) is required to apply insecticide to walls, ceilings and fences to the point of runoff. Wall sprays can be used for controlling houseflies and stable flies that rest on the walls. Usually, livestock should be removed from buildings before spraying. Avoid spraying feed and water.

## Backrubber

An inexpensive and effective device for applying insecticides is the backrubber (Figure 68). Various commercial types are available. Farmers can also manufacture backrubbers themselves. A simple form consists of 5 to 6 m (15 to 20 ft.) of cable, chain or wire around which several layers of burlap are wrapped. By regularly soaking the backrubber with a selected insecticide-oil mixture, these devices can be used year-round for controlling various pests.

## Pour-on

This quick and simple method of application was developed for systemic insecticides and can be used for controlling cattle grubs. Pour-ons are

**FIGURE 68.** Backrubber



usually concentrated solutions of either oil or water emulsions poured along the back line of the animal. They are most often used at the rate of 15 to 30 mL per 50 kg of body weight. Pour-on formulations are useful for treating cattle with lice during the winter months.

One of the disadvantages of topical medications is that they may be washed off before they are absorbed, if the cattle are exposed to rain or snow. Normal animal grooming may also remove the drug before it is absorbed.

### Spot Treatment

This method uses a highly concentrated solution of insecticide. Special applicators are used for applying the insecticides to the cattle. Small dosages, ranging from 4 to 20 mL, depending on body weight, are applied as spot treatment. Cattle grubs and cattle lice can be effectively controlled using this method.

### Dust

A small number of animals may be individually hand dusted with insecticides. Dusts can be applied by using a shaker can and then working the dust into the animal's hair coat with a brush or your hands. Make sure to wear plastic gloves rated for use with insecticide. Dusts are effective against both lice and horn flies.

### Dust Bags

A dust bag is a self-treatment device that consists of a heavy-duty burlap bag with a waterproof coating. These bags are hung in doorways or installed at the entrance to watering facilities or mineral salt licks. When the animal bumps or rubs against the bag, small quantities of dust sift through it and onto the animal.

Dust bags can be manufactured on the farm by purchasing insecticide and heavy burlap sacks. This is an inexpensive way of treating cattle for lice, horn flies and other insects.

### Insecticide Ear Tags

Insecticide-impregnated ear tags are a simple method for applying insecticides to cattle. The slow-release formulations of insecticide are spread on the hair coats and other parts of the body when animals groom themselves. Horn flies and face flies are effectively controlled using this method.

### Parasiticide and Insecticide Resistance

Livestock pests can develop resistance to insecticides and parasiticides. Resistance is the result of repeated use of one or more similar products over a number of years. In Alberta in the early 1990s, horn flies were confirmed to have developed resistance to synthetic pyrethroids.

Resistance to anthelmintics in nematodes has been slow to develop under field conditions in comparison to insecticide resistance in insects or antibiotic resistance in bacteria. However, resistance is likely to become more widespread because very few chemically dissimilar groups of anthelmintics have been introduced over the past decade. The development of resistance in nematodes seems to require nine to 10 generations of a nematode population.

Loss of control of one pest may be a sign that the pest is starting to develop resistance, especially if other pest species are controlled. Check to determine if the insecticide or parasiticide was adversely affected by weather conditions or misapplication.

Producers should attempt to prevent or delay the appearance of resistance through the rotation of insecticides and parasiticides by using chemicals with different modes of action. For example, if controlling horn flies, alternate control products in successive years among synthetic pyrethroid, carbamate and organochlorine insecticides. Alternating the mode of action helps prevent pests from developing resistance to any one of the classes of insecticides and parasiticides. This prolongs their effective use. However, the



ability to alternate between classes of control products may be limited due to the type of cattle or compatibility of the treatment method with the herd management system.

## Safety When Applying Pesticides

The *Pest Control Products Act* of Canada regulates the products used for the control of pests in animals. The Act and Regulations prescribe standards for registration, manufacturing, storing, displaying and use of pesticides to ensure their efficacy and safety. The *Environmental Protection and Enhancement Act* of Alberta and the *Environmental Code of Practice for Pesticides*, regulate the use, application, handling and disposal of pesticides in Alberta. If you are unsure if a product is a pesticide, look for a Pest Control Product (PCP) number on the container and read the label for indications that the product is regulated under the *Pest Control Products Act*.

## Personal Safety

To ensure the safety of you and your family, remember to:

- ensure pesticides are clearly labelled
- handle and store pesticides according to label directions
- store pesticides outside the reach of children
- store pesticides in original containers in locked, ventilated and climate-controlled areas
- apply pesticides at recommended doses
- wear protective clothing (e.g. gloves, respirator, suit) when handling pesticides
- wash thoroughly with soap and water immediately after handling pesticides
- dispose of empty pesticide containers according to label directions
- be careful do not contaminate lakes, streams, ponds, dugouts or sources of drinking water with pesticides

## Animal Safety

To ensure the safety of your animals, you should:

- follow label instructions for pesticide handling and storage
- apply pesticides at recommended doses
- not treat sick, emaciated or recovering animals with pesticides
- not treat animals less than three months of age with pesticides
- not contaminate animal feed or water with pesticides
- never store or mix pesticides within 30 m (100 ft.) of an open body of water
- not store pesticides near feed, water sources, or feed mixing and milling rooms
- not store pesticides within reach of animals
- not use pesticide-contaminated feed or water
- prevent animals from gaining access to feed that has been treated with insecticides to control grain insects
- keep animals away from pesticide containers
- follow the pre-slaughter withdrawal period recommendations (i.e. the time between pesticide application and slaughter) in order to avoid residue contamination of meat and milk
- check the label for restrictions regarding concurrent applications with other pesticides or other products
- not reuse pesticide containers

# Summary

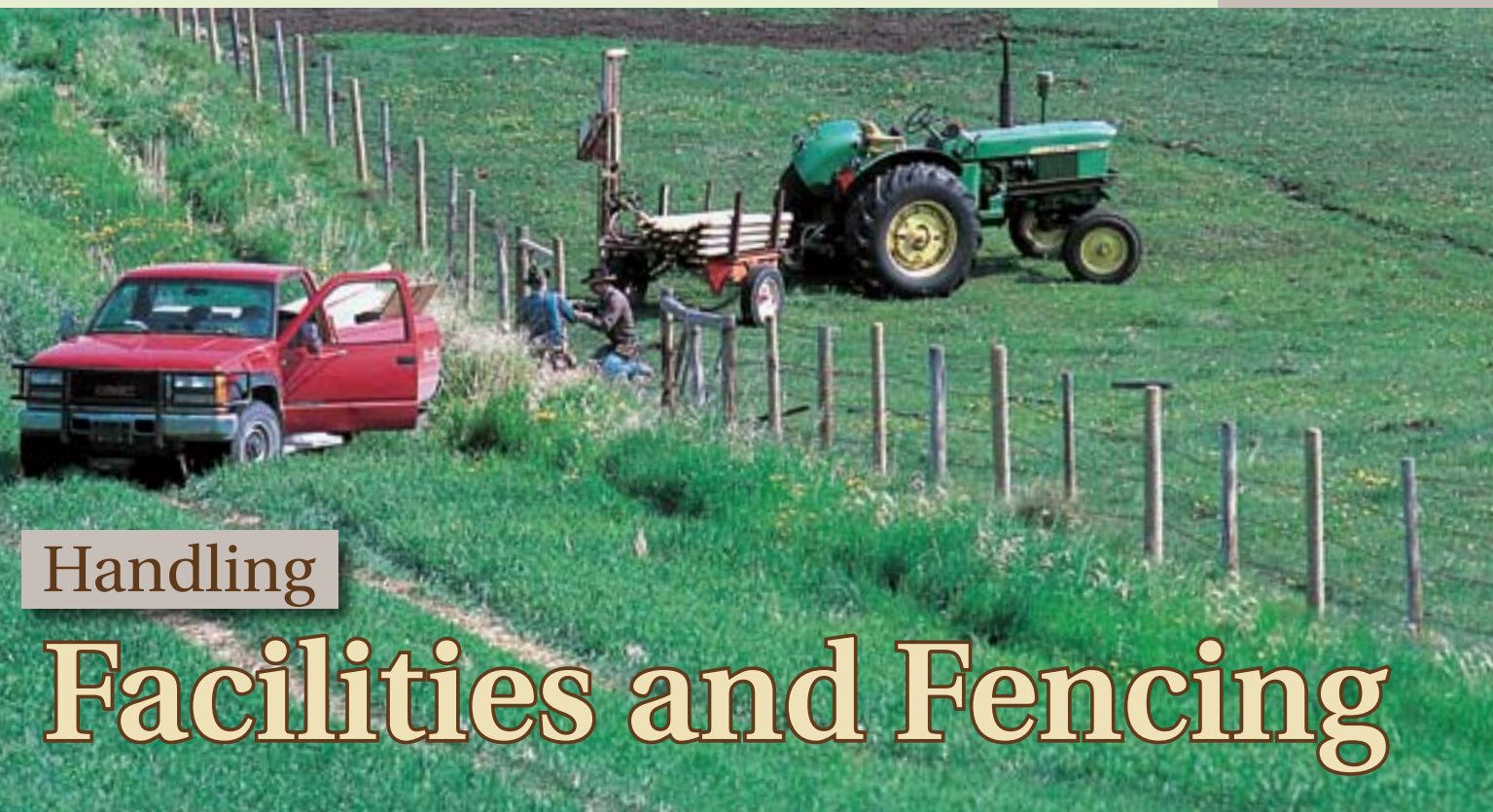
The impact insects and other parasites have on cattle can include reduced weight gains (cow and calf), decreased milk flow for the nursing calf, damage to hide and meat, and death.

The main external pests of cattle in Alberta are: warble flies, lice, mites, black flies, horn flies, mosquitoes, houseflies, stable flies, face flies and horse flies. The main internal pests are gutworms and lungworms. Pesticides, pasture and pen management, and nutrition can all play a role in reducing the impacts of pests on cattle. Specific control practices depend on the type of pest.

Pesticide products for use on cattle can be grouped into two main types: parasiticides including anthelmintics and endectocides, which control a wide spectrum of insects, mites and internal parasites; and, classical insecticides,

which control arthropod pests (e.g. insects and spiders). Insecticides and parasiticides are available in various types of formulations, including injectable products, wettable powders, dusts, emulsions and emulsible concentrates. Depending on the formulation, they can be applied in a variety of ways (injections, sprays, backrubbers, pour-ons, spot treatments, dusts, dust bags and ear tags). When possible, producers should alternate among the different classes of pesticides in successive years to prevent pests from developing resistance to any one of the classes.

Most pesticide containers include specific information about the product, its uses, and proper mixing, handling and storage methods. Read and follow the instructions on the label. This is important for protection of you, your family, your cattle and the environment.



## Handling

# Facilities and Fencing

Handling and housing facilities, and pasture fencing are important to the functioning of any cow-calf operation, both for the operator and for the livestock. This chapter provides information about designing cattle handling and housing facilities, including design considerations, recommended dimensions and helpful hints. It also describes various pasture fencing options and materials, provides recommendations for wire and post spacing, and outlines fencing practices and safety measures.

## Handling and Housing Facilities

The design of beef cattle facilities is largely a matter of providing the required space, shelter, feed, water, waste management and livestock handling features. The facilities must then be adapted to the natural features of the site and organized for efficient and easy operation.

Good cattle handling systems make work easy for limited manpower operations and confine cattle in a hazard-free environment. Well designed corrals:

- reduce handling time and operator requirements
- increase operator safety
- minimize animal injury and stress during treatment and handling operations

The operation of any cattle handling facility depends on cattle behaviour, corral design and the skill and technique of the handler.



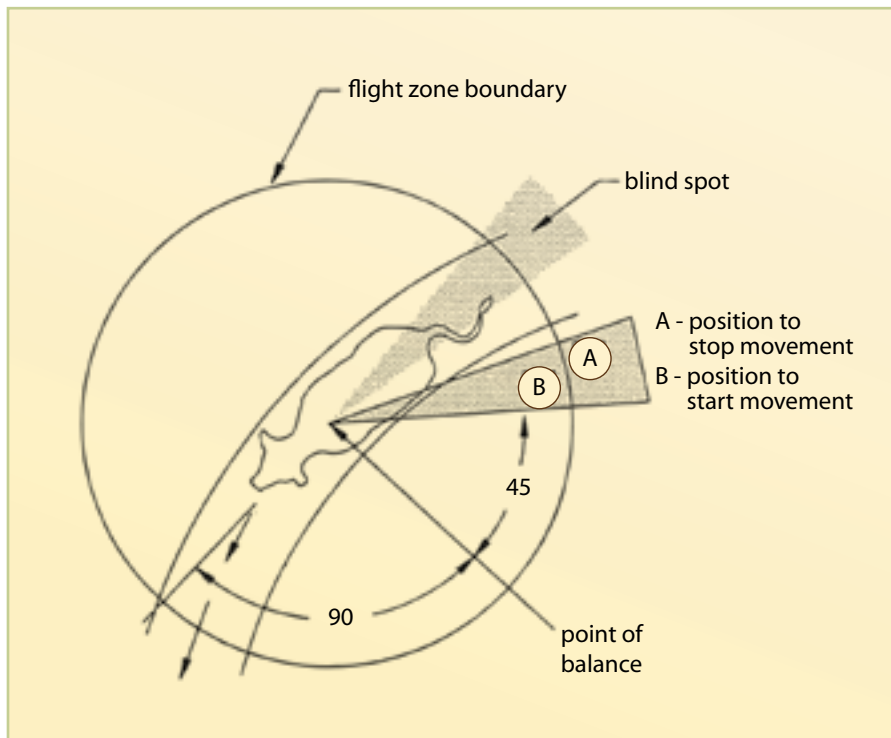
The number of cattle to be handled, the number of handlers and the time available all affect the appropriate corral design.

## Handling Behaviour

The “flight or fight” reaction is a common response in animals, including cattle, when they feel threatened. The flight zone is the animal’s personal space. If you move inside the flight zone, the animal moves away from you. When you back off, the animal stops moving.

The size of the flight zone depends on the wildness or tameness of the animal, angle of the handler’s approach and state of excitement of the animal. Cattle tend to move away from the people working with them. Work at the edge of the flight zone at an angle of 45° to 60° behind the animal’s shoulder. The cattle will circle away from you. If pressed too closely, they turn and charge, or try to escape by running past or over the handler. The flight zone radius may be 5 to 25 ft. for tame cattle and 300 ft. for range cattle (Figure 69).

Cattle have excellent wide angle vision, in excess of 300°, due to the position of their eyes.



**FIGURE 69.** Flight zone

Cattle can see behind themselves without turning their heads. Because cattle have a blind spot directly behind themselves, they circle so that they can keep a person, horse or working dog in view. Cows do have depth perception, but they have difficulty perceiving depth at ground level while they are moving with their heads raised.

Cattle are easily frightened or spooked by visual patterns of sharply contrasting bright and dark areas. For this reason, they resist going from a brightly lit area into a darkened doorway. They also balk when they see a shadow pattern of bars that appears to block their way as they go down an alleyway or working chute.

With this knowledge in mind, working corrals and chutes are designed with as few corners as possible. This stops the cattle from feeling trapped and reduces their desire to try to escape past the handler. Fencelines and working chutes are curved to allow the cattle to circle as they move away from the handlers. Circular crowding pens and chutes can reduce handling time by up to 50 per cent.

Working chutes and alleys near the working chutes have solid walls to eliminate shadow patterns and minimize the distractions caused

by outside movement that can cause the livestock to balk. Solid walls also help to reduce the chance of injury from legs being caught in the spaces between the planking of the working chutes.

Modern handling systems are designed to allow the cattle to think that they are escaping as they move away from the handler. Cattle move from the holding corral (through the working alley, the crowding gate and the working chute) to the squeeze where the processing is done.

Remember that the working corrals should be reserved for handling cattle. Cattle should be fed in a separate area that has easy access to the working corral system.



## Components of a Handling System

Cattle handling facilities are an essential part of any cattle operation. Well-constructed and functional handling facilities contribute much to the easy, safe and rapid handling of cattle. The handling system should be accessible to all pens and located in an area with all-weather access.

The main parts of the corral handling system are:

- holding corral
- crowding pen and gate
- sorting corrals and gates
- working chute and gates
- loading chute and alley
- squeeze and veterinarian gate
- scale
- hospital or sick pens (optional)

Corrals should be high enough to hold the “jumpers” found in almost every herd. Fences should be at least 6 ft. high. There should be 12 in. of free space at the bottom of fences to allow people to roll under if an animal decides to fight. Rough planking is stronger than planed lumber. It is more economical to use 2 x 6 lumber than 2 x 8 lumber.

### Holding Corral

The access to the holding corral requires careful planning. The gateway has to be a trap that the cattle will easily move into. A wing, provided

*Funnel and perimeter fence leading to a holding pen.*



*A crowding tub and alley.*



by corral-type fencing, may be used to lead the cattle to the pen. The closer the cattle get to the trap, the stronger the fence must be.

The shape of the holding corral must be designed to allow the fleeing cattle to imagine they are escaping. Ideally, it should have a curved perimeter fence and a funnel from the holding corral to the crowding gate leading to the working chute. Alternatively, a long narrow holding pen, 18 to 20 ft. wide, also works well.

In some cases the outer fence of the holding corral should be solid to avoid distracting shadow patterns that could cause cattle to shy away from it.

### Crowding Pen and Gate

Crowding pens are used to move cattle from a large holding pen to a single-file working chute. Use a small crowding pen or crowding tub that handles eight to 10 cattle at a time. It needs to be large enough to allow animals to turn and have room to move.

Crowding pens should have solid walls and a solid crowding gate. The solid walls act like blinders on a horse – the cattle can't see distractions outside the pen. They will leave by the one open path, being the entrance to the single-file working chute. Circular crowding pens are very effective as cattle can see only one escape route through the single-file working chute.

The crowding gate must be heavy, easy for the handlers to push and solid so cattle cannot see the handler and a possible escape route behind him. The only obvious escape should be through the exit to the working chute. The crowding gate is usually 12 ft. long and it swings in an arc from 180° to 300° behind the cattle. The gate should have a ratchet

latch that prevents the cattle from pushing it back against the operator. The gate must not sag or put strain on the fence itself. The gate should also be designed to lift easily over a buildup of snow. Commercially available steel gates, hung on steel posts, are the longest lasting and most economical solution.

## Sorting Corrals and Gates

Sorting corrals should have the same capacity as the holding pen. For most cow-calf operations, three sorting corrals are adequate. They all must have access so that cattle can be routed either back into the holding pen or to the crowding pen for reworking.

For many smaller farm herds, it is convenient if the corral system allows for one-man operation. This requires special attention to the placement of the sorting gates so they can be used to lead the cattle from the squeeze chute area into the sorting corrals.

## Working Chute and Gates

The working chute lines up the cattle in single file and sends them to the squeeze or scale. The chute should be tightly planked and be about 28 to 32 in. wide inside, for uniform mature animals. For handling calves and smaller animals, narrower chutes are needed (Table 68). Two options for varying the chute width are to taper it or use temporary filler panels in a straight-sided chute.

Many working chutes are tapered from a width of 28 to 32 in. at the top, to a width of 16 to 18 in. at the bottom for handling calves under 272 kg (600 lb.) (Figure 70).

*Fully tapered chute.*

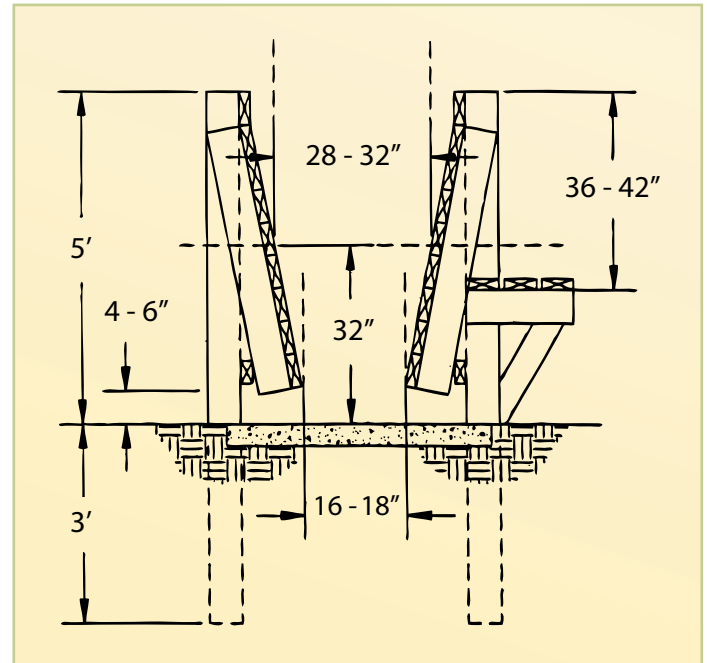


The width at 32 to 36 in. above ground level still has to be 28 to 32 in. This tapering allows the chute to accommodate the largest herd bull while still preventing most calves from turning around in the chute.

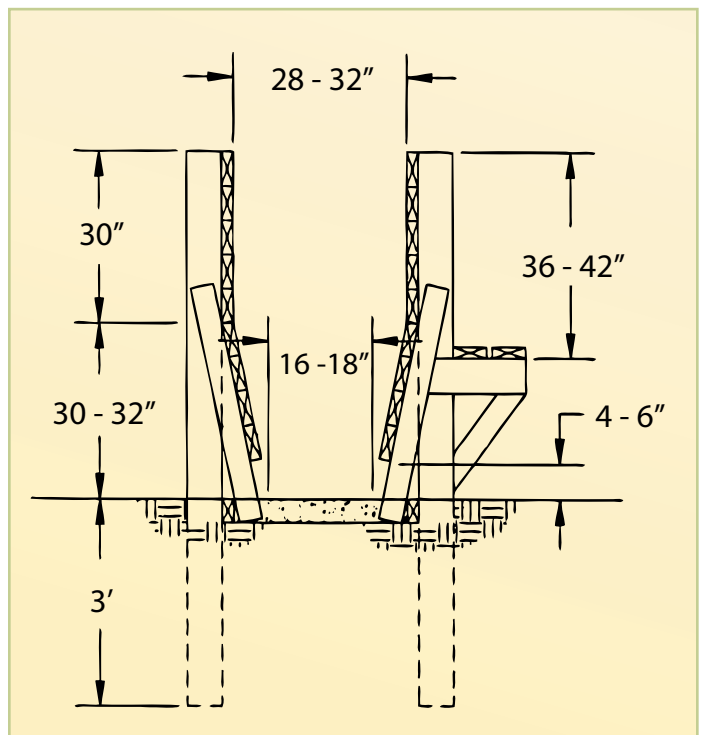
A half-tapered version, which is easier to build, can also be used (Figure 71). After the posts are set, nail a 2 x 4 along the inside at the bottom. This serves as a form for the concrete, as well as a support for the tapered side.

It is 16 to 18 in. wide at the bottom and 28 to 32 in. wide at 32 to 36 in. above the ground. Above this point the walls are straight.

Tapered chutes may be a problem with cattle that go down or topple backwards. If an animal rears up in a chute, back out of its flight zone.



**FIGURE 70.** Fully tapered chute



**FIGURE 71.** Half-tapered chute

TABLE 68. Minimum working chute width

Type of working chute	Animal Size		
	Under 600 lb.	600 – 1,200 lb.	Over 1,200 lb.
Straight-sided chute width	18 in.	22 in.	28 in.
Fully tapered chute - width at 32 in. height	18 in.	22 in.	28 in.
Fully tapered chute - width at bottom	15 to 16 in.	16 in.	18 in.

Source: Borg et al. (1993)

Working chutes should be at least 5 ft. high and should incorporate a catwalk for the handler to work from. The catwalk should be a minimum of 18 in. wide and should be 36 to 42 in. below the top of the working chute. There should also be steps for the handler to use to get onto the catwalk. The length of a working chute should be at least 20 ft. and no more than 50 ft. If cattle can see at least two body lengths ahead, they don't feel as if they are walking into a dead end.

Curved working chutes take advantage of the cattle's natural circling behaviour. The maximum curve for a curved chute is a 15° angle. This means the chute should be built on a curve that corresponds to the outside of a circle with a radius of 16 to 25 ft.

Blocking gates should be included as part of the working chute. Blocking gates at the entrance and exit of the chute prevent unwanted animal movement and allow safe and stress-free cattle containment. Three types of gates can be used as blocking gates:

- A solid blocking gate (Figure 72) is solid so cattle can't see through it. It is used at the entrance and exit of the working chute or between the chute and squeeze, or when a palpation or vet gate is needed. The gate at the entrance to the working chute or between the

crowding pen and chute should be open or "see-through" so that cattle can see an escape path. This prevents balking.

- One-way gates (Figure 73) or chains allow cattle to move forward in the chute, but prevent them from backing up. Locate the gate 12 ft. ahead of the squeeze.
- A one-way chain gate (Figure 74) has a suspended chain that allows cattle to move forward in the chute, but prevents them from backing up. Cows and calves can be handled by varying the chain height. Keep an 8 to 12-in. sag in the chain.

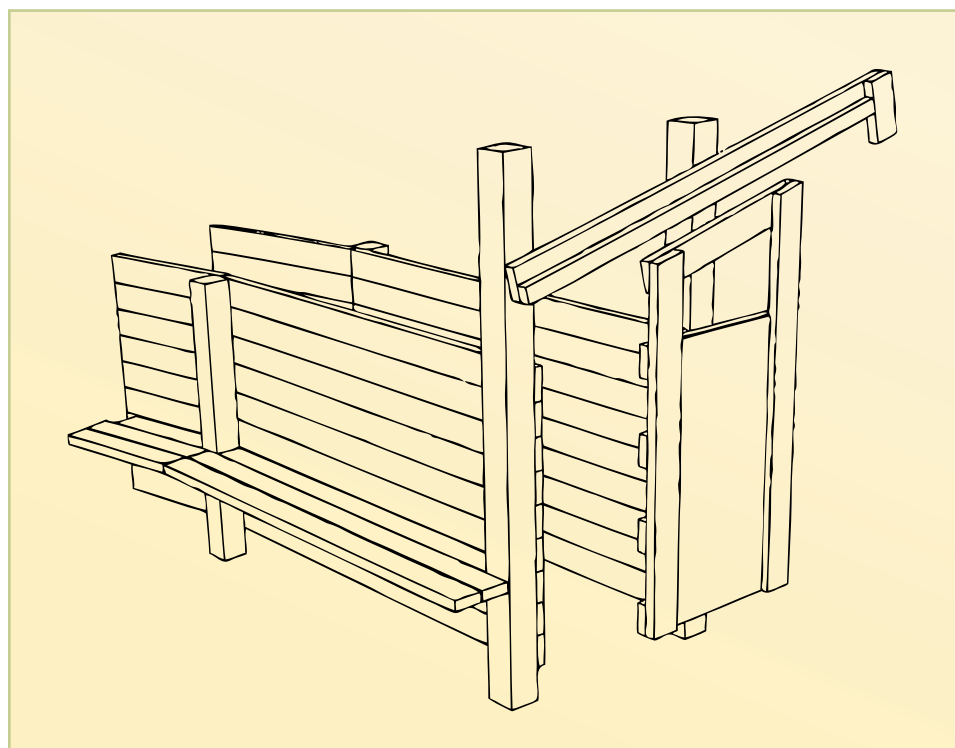
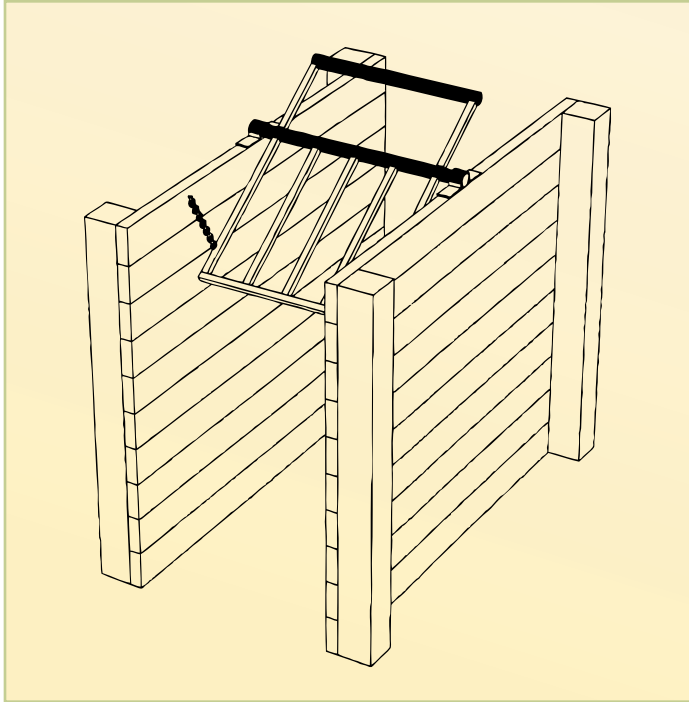
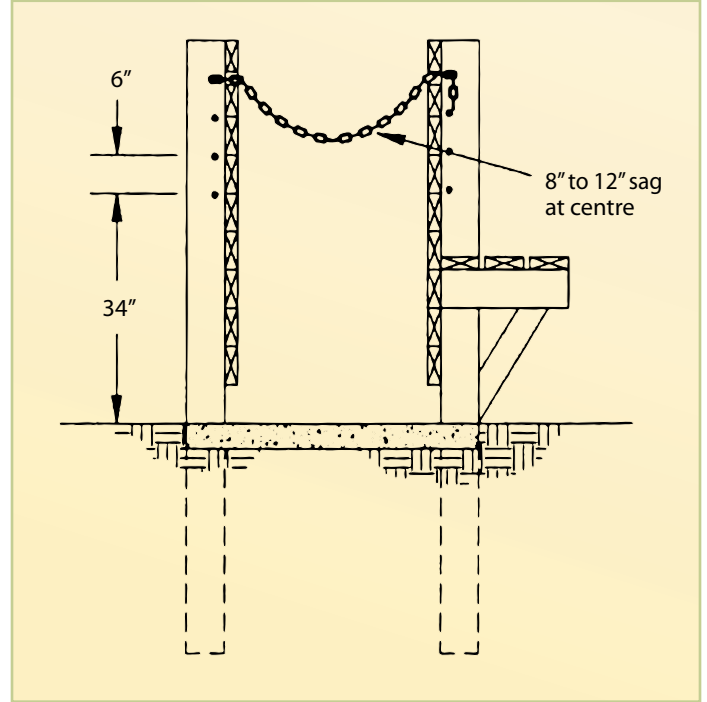


FIGURE 72. Solid blocking gate



**FIGURE 73.** One-way gate



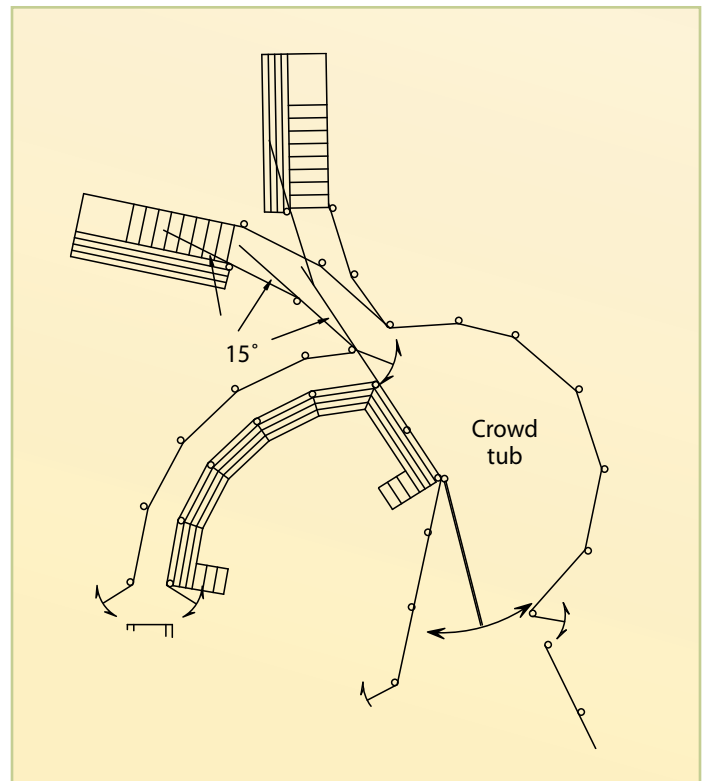
**FIGURE 74.** One-way chain gate

## Loading Chute and Alley

The lead-up alley to the loading chute (Figure 74) should be located at an angle to the working chute, directly past the crowding gate. The gate and fence between the two chutes become a baffle gate, which deflects the cattle either way. The loading alley shouldn't be any longer than about two animal lengths. This minimizes handling problems if the lead animal decides to balk. The loading alley should be curved in a "dog leg" so that cattle don't see the inclined ramp (chute) leading into the truck. Two or three 15° curves (about 2 ft. in 8 ft.), one at the loading alley entry, one in the middle of the alley and another at the bottom of the ramp, will do well.

The ramp should be 30 to 35 in. wide for single-file movement or 54 to 72 in. wide for larger groups. It should be about 16 ft. long. A flat landing stage, about 5 ft. long at the top of the ramp, provides good footing for cattle as they walk on or off of the truck.

Another option that works equally well is a long platform loading chute. It should be 28 to 32 in. wide by 16 ft. long and fully adjustable from ground level to cattle liner height.



**FIGURE 75.** Loading alley and chute



## Squeeze Chute and Veterinarian Gate

A squeeze chute can be purchased. Place the squeeze at the exit end of the working chute. Whatever the model, it should provide humane constraint without choking the animal, no matter what the size of the animal. The working chute should be designed with a 2-ft. access gate for veterinary work. It should be located immediately behind the rear entry to the squeeze.

## Scale

Scales can either be single or platform, mechanical or electronic, and fixed in place or portable. A single-animal scale is essential for obtaining accurate performance records of cattle. Most cow-calf operations do not need a large scale to weigh cattle in groups.

Avoid placing a scale in line with the working chute because every time an animal goes through the chute it would have to pass over the scale, which would put undue traffic on the scale. Use a bypass between the working chute and the squeeze to solve this problem. In some systems, cattle are weighed using a portable scale placed just in front of the squeeze chute. Another option is to outfit the squeeze chute with an electronic scale system. An electronic system consists of a digital readout and load or weigh cells that are placed under the squeeze.

The location of a platform scale is not as critical, but it should be located so both feed and cattle can be weighed. A platform scale can be used as a group scale to weigh groups of cattle, but it needs a cage added to hold the cattle. If groups of cattle are weighed on a regular basis before shipping, place the group scale before the loading chute. Most platform scales use electronic load cells and do not require pits. If the platform scale is used only for weighing bales, feed wagons or trucks, then a cage is not required and the scale should be placed out in the feedyard where it is convenient for vehicles to access it.



*A livestock scale.*

## Hospital Pens

A hospital or sick pen is a useful addition to any cattle lot, and a necessity for larger ones. It eliminates the need to separate an animal from the main herd each time it needs to be treated. This minimizes stress on both the ailing animal and the operator, especially when daily treatment is required for an extended period of time.

Sick pens should be sheltered, well bedded and located near the working facilities. The space required is not large, 15 to 20 square feet (ft.<sup>2</sup>) for a shelter plus 40 to 60 ft.<sup>2</sup> of pen area per head, based on five per cent of the herd.

## Housing and Shelter

Cattle suffer more from mud, harsh winds and excessive moisture than from low temperatures alone. Windbreaks and open-front sheds usually give adequate protection. For winter and early spring calving, a dry, draft-free area is desirable. Good planning of housing facilities can reduce labour, save time and feed and keep capital costs to a minimum.

Good tree groves make excellent windbreaks. Pens built 100 to 150 ft. downwind from the windbreak allow room for snow to get trapped before it gets into the pens. Windbreak fences are a good alternative to trees. They should be 20 to 30 per cent open and 70 to 80 per cent solid (e.g. an 8-in. plank with a 2.5-in. gap between the planks) and at least 8 ft. high.

To provide protection from wet snow, rain, wind and extreme temperatures, open-front sheds are often used. They normally are naturally ventilated buildings and the most common ones are of a pole construction. A single sloped shed is the least expensive to build. The runoff from the roof goes to the back of the shed and sunlight reaches to the back of the shed.

The open-front, clear span buildings can allow a deeper shed. This reduces the amount of snow entering the building. It also allows for easier entry

with a tractor and scraper for cleaning the shed. The open-end pole barn helps modify winter temperatures, but one can encounter moisture problems if relying strictly on natural ventilation. A cool, dry calving barn is much more desirable than a warm, humid one. A common practice is to make pens in the back of an open-front shed. If these pens are kept well bedded and a heat lamp or infra-red lamp is used, the conditions can be quite comfortable. Avoid completely enclosed buildings unless they are fully insulated, ventilated and heated.

TABLE 69. Recommended dimensions for beef cattle corrals and handling facilities

Facility	Measurment Units	Animal Size		
		Under 600 lb.	600 – 1,200 lb.	Over 1,200 lb.
<b>Holding area (per animal)</b>				
• Worked immediately	ft. <sup>2</sup> /animal	14	17	20
• Held overnight	ft. <sup>2</sup> /animal	45	50	60
<b>Working chute w/vertical sides</b>				
• Width	in.	18	22	28
• Desirable length	ft.		24	
<b>Working chute w/sloping sides</b>				
• Width at bottom	in.		22	
• Width at 5 ft. height	in.		32	
• Desirable length (minimum)	ft.		24	
<b>Working chute and feedlot line fences</b>				
• Recommended height	ft.		5	
• Depth of posts in ground	ft.		3	
<b>Corrals and bull pen fences</b>				
• Recommended height	ft.		5	
• Depth of posts in ground	ft.		4	
<b>Loading chute</b>				
• Width	in.		30 - 32	32
• Length (minimum)	ft.		12	
• Slope	rise:run		1.4	
<b>Ramp height for:</b>				
• Gooseneck trailer	in.		15	
• Pickup truck	in.		28	
• Van-type truck	in.		40	
• Tractor trailer	in.		248	
• Double deck	in.		100	
<b>Access or collecting alley</b>				
• Width	ft.		12	

Note: Cow-calf operations should use dimensions for over 1,200 lb.

Source: Adapted from Canada Plan Service M1800.

## Design of Handling and Housing Facilities

Table 69 provides the recommended space requirements for different classes of cattle in various handling facilities. Table 70 provides guidelines for housing beef cattle. These two tables should be used as reference guides when planning and laying out facilities.

### Working Area Options

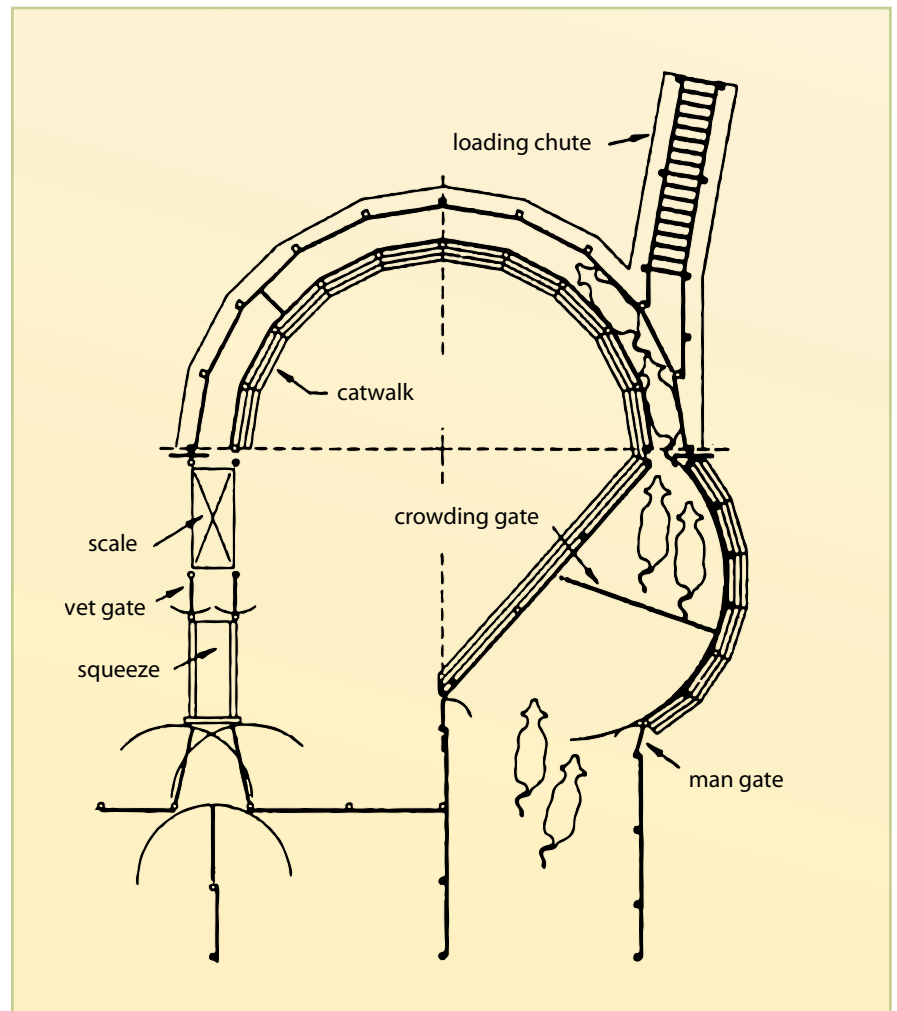
All handling systems consist of a series of individual components. After the crowding, treatment and loading areas have been designed, they must be combined into a working area that meets the requirements of the operation. Good working areas allow for a smooth flow of cattle and provide convenient access to the cattle for handlers. The proper combination of components in a working area can be the most important factor in the successful operation of the handling system.

The first consideration in developing a working area is the limitations imposed by the site. The design must be suitable for the amount of space, the topography of the land, co-ordination with other buildings and facilities and vehicle access. Beyond the site considerations, the layout of the working area is largely governed by personal preference and the way cattle are handled on the particular operation.

Several of the possible working area combinations are shown below (Figure 76 to Figure 79). The diagrams (where applicable) illustrate the main factors in working area design. The factors include:

- direction of cattle flow on entering and leaving the facility

- crowding pen size, curvature and handler location
- working chute length, style (half circle, quarter circle, “S” curve or straight), direction of curve and working side



**FIGURE 76.** Working area combination – option one

- scale design (single or group, combination cattle and truck) and location (inside or adjacent to the working area)
- loading chute and trailer loading designs and locations; and, an unloading system

TABLE 70. Guidelines for housing beef cattle

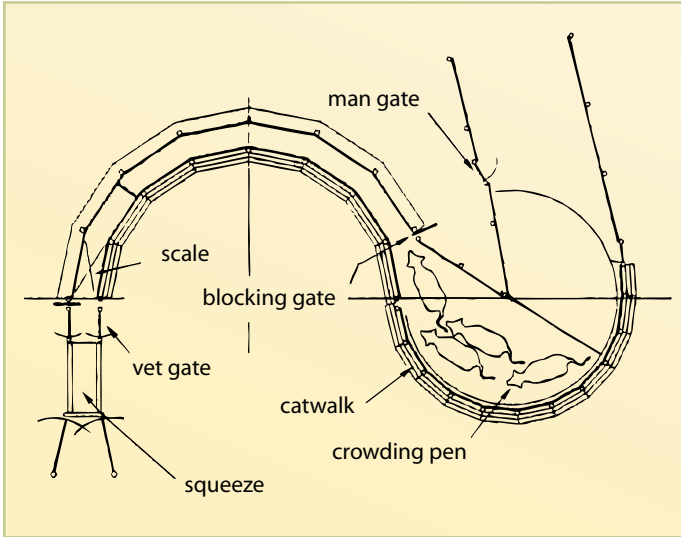
Requirements	Measurement Units	Cows and bred heifers	Calves to 500 lb.	Yearlings to 750 lb.	Heavy feeders to 1,100 lb.
<b>Feedlot without shed</b>					
Pen area - paved <sup>a</sup>	ft. <sup>2</sup> /head	80	40	45	80
- soil <sup>b</sup>	ft. <sup>2</sup> /head	300	150	250	300
- bedded mound area <sup>c</sup>	ft. <sup>2</sup> /head	35	25	30	35
<b>Feedlot with shed</b>					
Pen area - paved	ft. <sup>2</sup> /head	50	25	30	50
- earth	ft. <sup>2</sup> /head	300	150	250	300
Shed - floor area	ft. <sup>2</sup> /head	30	15	20	30
- min. clearance height	ft.	10	10	10	10
<b>Slotted floors</b>					
Space/animal (100% slotted)	ft. <sup>2</sup> /head	30	11	16	27
Or general rule of thumb	2 to 2.7 ft. <sup>2</sup> /100 lb. of live animal				
<b>Maternity pens</b>					
additional, not slotted	cows/ 10 x 10 ft. pen	1 pen/20 cows	-	-	-
<b>Water</b>					
surface area	ft. <sup>2</sup> /100 head	4	4	4	4
daily demand, average	gal./1,100 lb. live weight	11	5	8	10
daily hot weather demand, average	gal./1,100 lb. live weight	16	10	15	20
<b>Feed bunk<sup>d</sup></b>					
limit feeding	in. of bunk length/head	26 - 30	18 - 22	22 - 26	26 - 30
full or self-feeding	- roughages only	8	6	8	8
	- complete ration	6	5	6	6
	- grain and concentrates only	3	2	3	3
max. height at throat	in.	22	18	18	22
max. reach (top edge of throat board to far bottom corner)	in.	34	24	30	34
limit feeding roughages with electric wire or feed fence	in. of bunk length/head	20 - 24	12 - 16	16 - 20	20 - 24
<b>Feed storage</b>					
hay without silage	lb./head/day	26 <sup>e</sup>	12 <sup>e</sup>	15 <sup>e</sup>	11 <sup>f</sup> (6 <sup>g</sup> )
silage, 60% moisture, without hay	lb./head/day	60 <sup>e</sup> - 75 <sup>e</sup>	35	-	25 <sup>f</sup> (13 <sup>g</sup> )
	lb./day/100 lb. live wt	-	-	4.5 - 5 <sup>h</sup>	-
grain and concentrate, 10% moisture	lb./day/100 lb. live wt	0.25 - 0.5/cows 1.0 - 2.0/heifers <sup>f</sup>	0.7 - 0.9	4.5 - 5 <sup>h</sup>	7 <sup>f</sup> (10.4 <sup>g</sup> )
<b>Bedding storage</b>					
except for slotted floors	lb./head/day	5	3	4	5
<b>Manure storage</b>					
with bedding	ft. <sup>3</sup> /head/day	1.2	0.6	0.8	1.2
no bedding	ft. <sup>3</sup> /head/day	1.0	0.5	0.7	1.0

a. Slope: 2% to 4% on concrete. (Per cent slope example: 4% = rise of 4 ft. for 100 ft. of horizontal distance.)  
 b. Slope: 4% to 8% on soil.  
 c. Slope of mounds is 1:4 or 25%. Sawmill chips and shavings can be used as well as straw for bedding mounds.

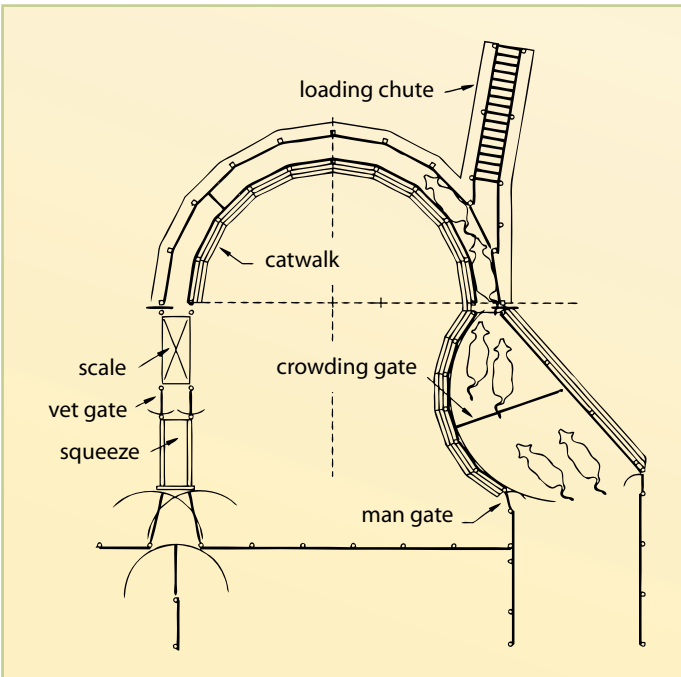
d. Bunk width: 47-in. if fed from both sides; 54 to 60-in. if divided; 18-in. bottom width, if fed from one side.  
 e. Maintenance only  
 f. High forage ration: average intake 26 lb./day based on 10% moisture content and feed intake 2.8% of live weight.

g. High grain ration: average intake 28 lb. based on 10% moisture content and feed intake 3% of live weight.  
 h. Grain may be substituted for hay at 1:15 respectively.  
 Source: Adapted from Canada Plan Service 1000, 84:07.





**FIGURE 77.** Working area combination – option two

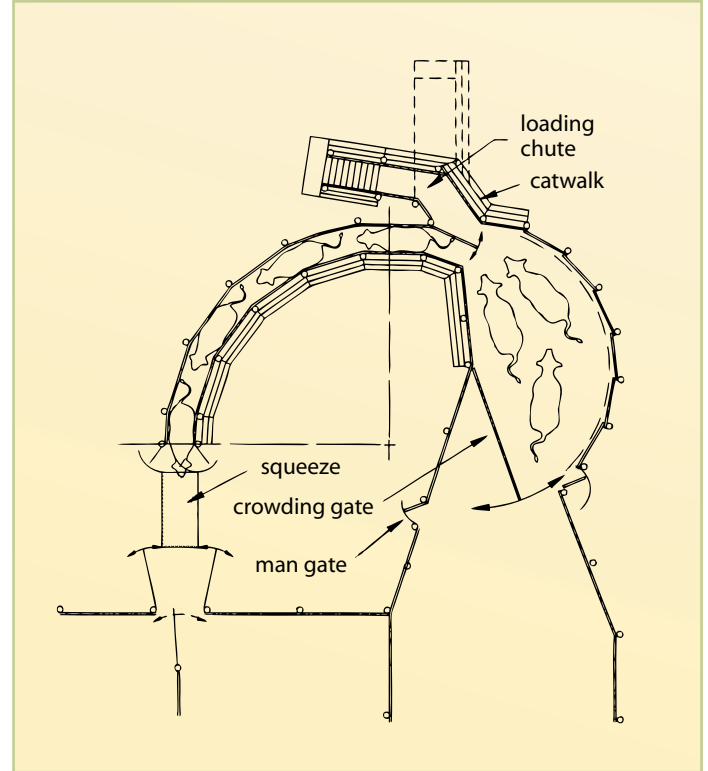


**FIGURE 78.** Working area combination – option three

## Steps for Laying Out a Corral Handling System

### Materials

Gather the following materials: a 50 or 100-ft. measuring tape, 100 4-in. to 5-in. nails, two colours of surveyor's flagging tape, 200 ft. of baler twine and a carpenter's hammer.



**FIGURE 79.** Working area combination – option four

Choose the most available building material. If lumber is to be used, rough is better than planed lumber and 2 x 6s are more economical than 2 x 8s. Before staking out the corral plan, you must determine the lengths available. Generally, 16-ft. lumber is best, with posts at stress spots at 28 ft. apart. If rails are to be used, fire kilned (peeled) rails are best. They should be sorted for uniform length.

### Location

As noted above, the working area's design must consider the site characteristics, personal preferences and the way cattle are handled on the particular operation. For example, if you usually brand your cattle, then the layout of the corral system is determined by the registered brand location on the cattle. Once in the squeeze, the brand side of the cattle should be exposed to the inside of the curved chute.

Once a plan has been chosen that fits the corral site, locate the position of the loading chute so as to allow easy access for trucks. This determines the location of the rest of the corral system.



*A one-way gate in circular alley.*

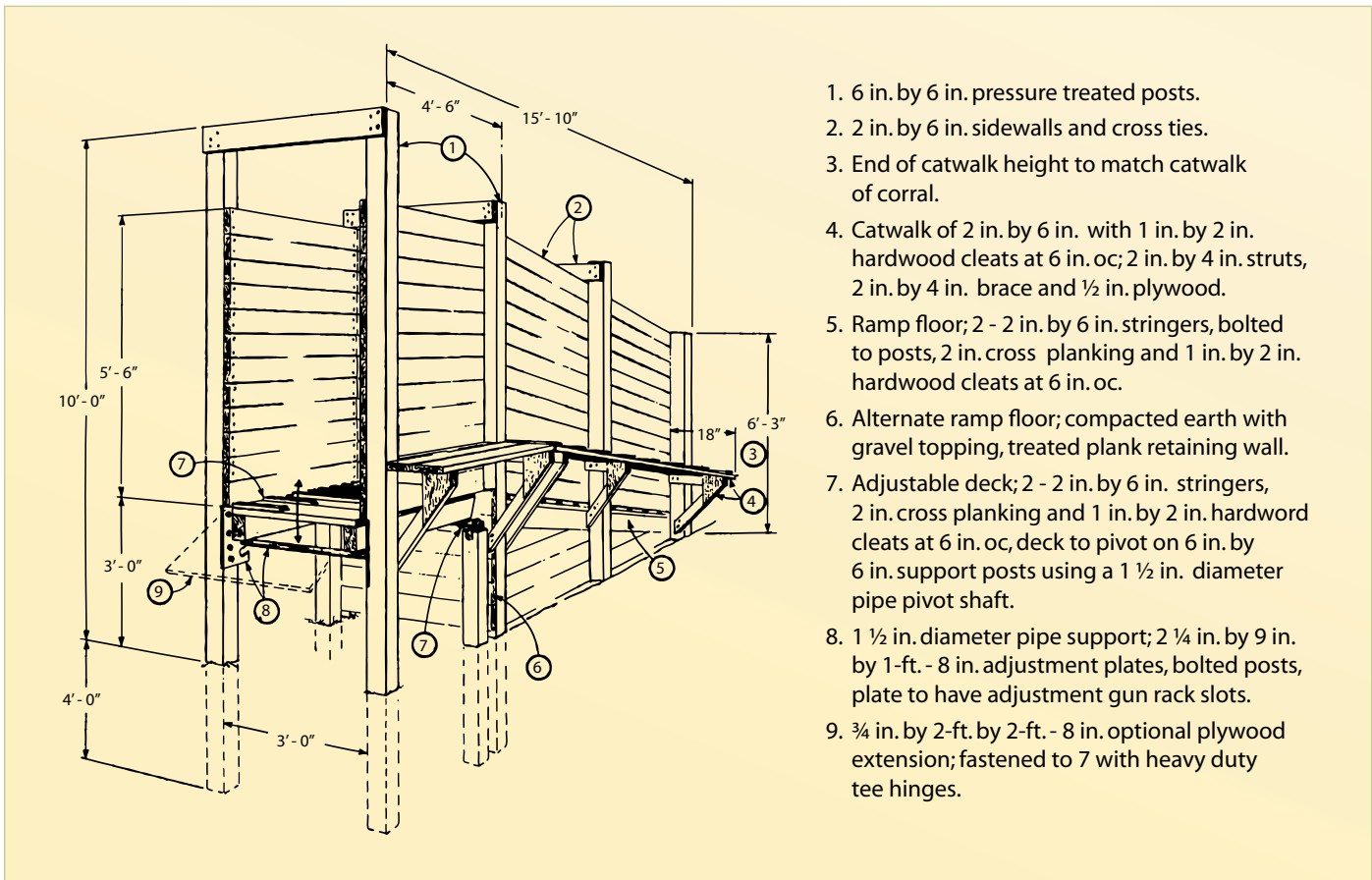
Choose one of the two colours of the surveyor's flagging tape and place two nails flagged with that colour to mark the posts at the end of the loading chute, where the truck will touch. These nails should be either 38 or 64 in. apart, depending on the width of the chute. Keep the other colour of flagging tape for locating the large gateposts.

## Laying Out the Loading Chute

With the measuring tape anchored on one spike at a time, measure back 8 ft. and flag, then 16 ft. and flag with the colour used at the end of the loading chute. Have a 15° bend, and be sure to keep the flagged spikes either 38 or 64 in. apart.

Note that the nail, which pierces through about 3 in. of flagging, is placed exactly where each post goes (Figure 80). Most of the posts will be 6 in. by 9 ft., allowing for 3 ft. in the ground and 6 ft. on which to nail planks.

The choice of a 38-in. wide loading chute with flags provides a finished inside dimension of 28 in. The 64-in. width provides a finished inside dimension of 54 in., the other width you may choose for your loading chute.



**FIGURE 80.** Loading chute design

## Laying Out the Curved Working Chute

The geometry of laying out curved fences, working chutes and crowding tubs is explained in the following diagrams (Figure 81 and Figure 82) and charts (Table 71, Table 72 and Table 73). Use a long tape measure to set out the circles. Anchor the end of the tape with a pin to establish the centre point of the arc.

1. locate the centre of the working chute (Figure 81). Draw an arc equal to the chute radius (R).
2. mark the post locations at distances of S along the arc marking the outside of the chute.
3. locate the inside posts at a distance of W on a line connecting the outside post to the centre of the working chute. The finished inside dimension is the critical dimension for any chute.
4. cut the planks to length and assemble the working chute.

Table 71 shows dimensions for various sizes of single-file working chutes. The layouts assume that 6-in. posts and 2-in. thick planks are used.

## Locating the Squeeze

After the arc is completed, place the last two flagged nails for the posts that will anchor the squeeze. Arrange these posts to provide a small gate for a veterinarian, behind the squeeze.

Measure the length of your squeeze, and temporarily outline its position at the end of the chute. If possible, actually put the squeeze in place.

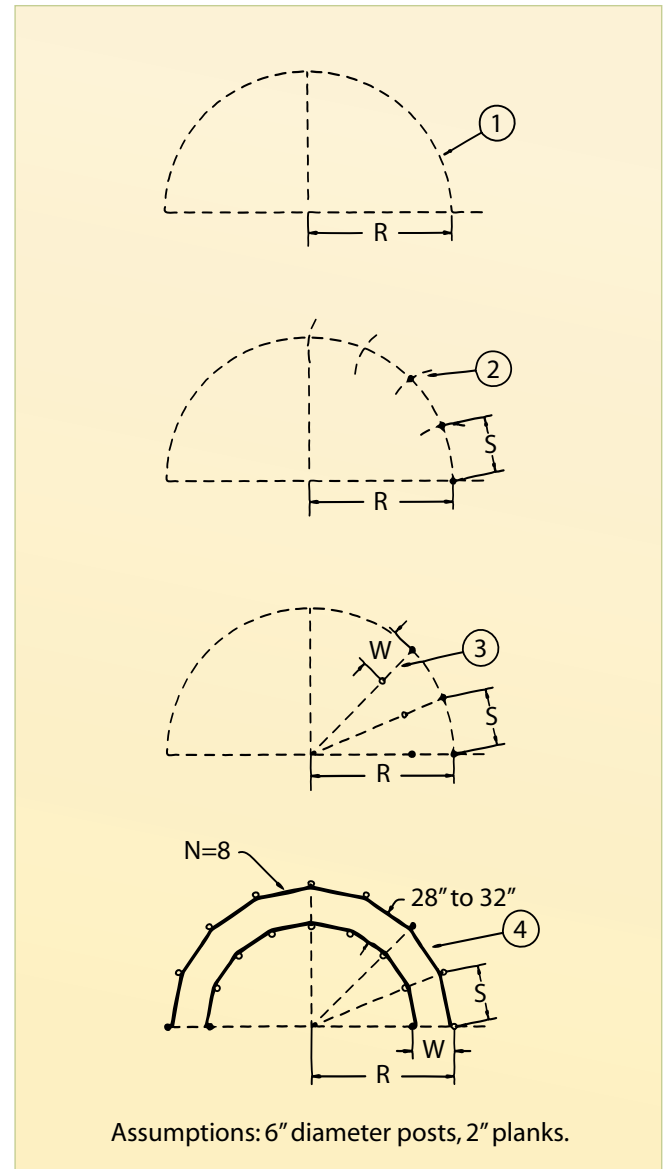


FIGURE 81. How to lay out a circular working chute

TABLE 71. Dimensions for various sizes of single-file working chutes

Chute radius (R)	Outside post spacing (S)	Number of sections (N)	Width of post spacing (W)	
			28-in. chute	32-in. chute
8 ft.	4 ft. 2 in.	6	3 ft. 3 in.	3 ft. 7 in.
12 ft.	6 ft. 3 in.	3	3 ft. 3 in.	3 ft. 3 in.
	4 ft. 9 in.	8	3 ft. 3 in.	3 ft. 7 in.
16 ft.	6 ft. 3 in.	8	3 ft. 3 in.	3 ft. 7 in.
	4 ft. 2 in.	12	3 ft. 2 in.	3 ft. 6 in.
20 ft.	6 ft. 3 in.	10	3 ft. 3 in.	3 ft. 7 in.
	4 ft. 6 in.	14	3 ft. 2 in.	3 ft. 6 in.
24 ft.	6 ft. 3 in.	12	3 ft. 2 in.	3 ft. 7 in.

## Laying Out Interior Fences and Gates

Now, lay out and flag the interior corral fences. The alley leading into the tub should not be wider than 12 ft. Sorting corral divisions should be laid out starting 10 ft. away from the front of the squeeze.

Finally, wind string around all your flagged nails, so that the details show up. Cut the string at all gates and substitute with surveyor's flagging. Walk through your corral and adjust it where necessary.

## Laying Out a Circular Crowding Tub

1. Locate the centre of the tub (Figure 82). This is the location of the crowding gate hinge post. Draw an arc equal to the crowding tub radius (R).
2. Mark the post locations at 4-ft. (Table 72) or 6-ft. (Table 73) distances (S) along the arc.
3. Put in the centre post and hang the crowding gate (G). Cut the planks and build the tub walls.

TABLE 72. Dimensions for a circular crowding tub with 4-ft. post spacing

Post spacing (S)	Gate length (G)	Tub radius (T)
4 ft.	8 ft.	8 ft. 8 in.
	10 ft.	10 ft. 7 in.
	12 ft.	12 ft. 7 in.
	14 ft.	14 ft. 7 in.
	16 ft.	16 ft. 6 in.

TABLE 73. Dimensions for a circular crowding tub with 6-ft. post spacing

Post spacing (S)	Gate length (G)	Tub radius (T)
6 ft.	8 ft.	8 ft. 11 in.
	10 ft.	10 ft. 10 in.
	12 ft.	12 ft. 9 in.
	14 ft.	14 ft. 9 in.
	16 ft.	16 ft. 8 in.

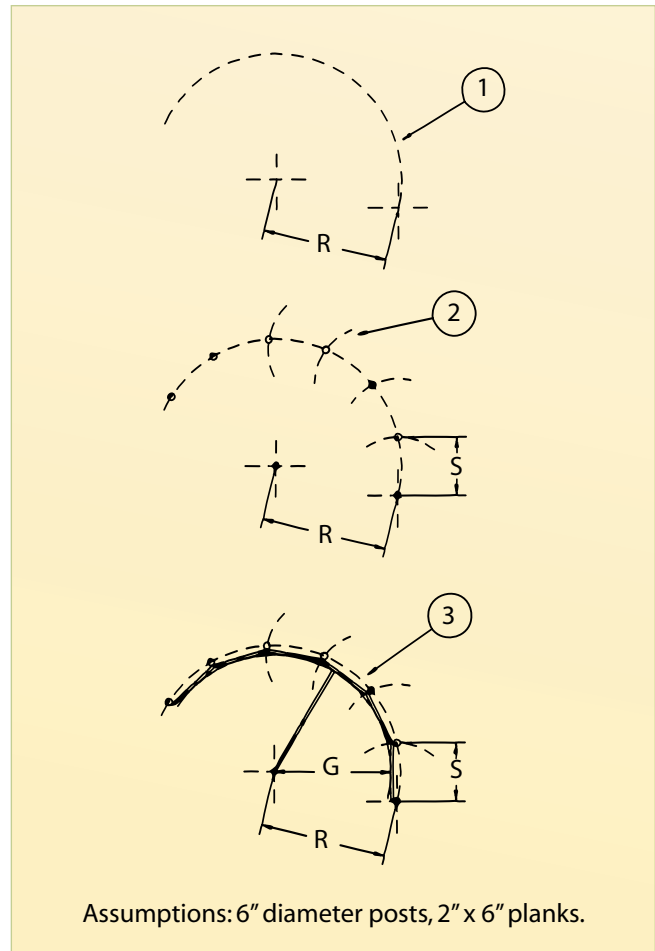


FIGURE 82. How to lay out a circular crowding tub

## Calculating Materials

Count the flagged nails to decide how many posts are needed. Add up all the 8-ft. sections, divide by two and multiply by six in order to determine the number of 2 x 6-in. by 16-ft. planks needed. Multiply this number by 16 board feet to calculate the total board feet of lumber needed for the 2 x 6 plank fences. Cattle are easier to handle if the fences are solid planked. This is particularly important at the tub and throughout both the loading chute and the chute leading to the squeeze.

## Construction

When planking a fence, first nail on the bottom plank so that there is a uniform 12-in. space between the ground and the plank.

Then, using a 6-in. spacer, nail on all the other planks. All the posts should be pressure-treated and



placed 3 ft. into the ground. All the posts should stick up at least 6 ft. above ground, except in the chute leading to the squeeze, where 5 ft. is enough.

This means that most of the posts should be 9 ft. long. The squeeze chute posts will be 8 ft. long. The main gateposts (with gates 12 ft. or longer) should be 12 ft. long. Preferably, these are made of steel. The sorting gateposts, positioned 10 ft. from the front of the squeeze, need to be 8 ft. long.

## Checklist for Corral System Design

Table 74 provides a checklist to follow when designing your corral layout. Use this table as a troubleshooting guide during planning. Work through the table, inserting a check on the left side of the table when the helpful hint has been addressed during planning.

TABLE 74. Checklist for designing a corral system

Helpful planning hints		✓
1.	Ensure that your planning of the corral system layout allows for expansion as your beef herd grows.	
2.	Ensure that the corral system layout suits any equipment to be used during cleaning and maintenance.	
3.	Double check dimensions regarding cattle space requirements.	
4.	Ensure alleys are no wider than 20 ft.	
5.	Have at least two sorting corrals in your plan, one that is 60 per cent and the other 40 per cent of the area of the holding corral.	
6.	Allow for the addition of another sorting corral near the squeeze by adding another gate at a later time.	
7.	To save time and improve convenience insert as many man gates as economically feasible.	
8.	Ensure that a power outlet is located at the squeeze to use for electric clippers, dehorers, branding irons and electric heaters.	
9.	Plan to install a yard light(s) for working areas; put the lights in locations that are not accessible to cattle.	
10.	Eliminate corners on a right angle as these can harm animals.	
11.	Don't dead-end your chute or locate it in a dark, unlit area.	
12.	Design the layout based on your registered brand location.	
13.	Locate working corrals wherever cattle normally like to travel.	
14.	Avoid long straight alleys as cattle should flow through the system.	
15.	Locate the load out where there is easy access for trucks and liners.	
16.	Make sure powerlines are not located in areas where vehicles or machinery may come into contact with the power line.	
17.	Make sure gates are secured and hung at the proper height to ensure safety.	
18.	Ensure a space is set aside for the working area to have a working station to hold syringes, medications, a recording system, ear taggers, etc.	
19.	Use wood preservatives wherever wood touches wood.	
20.	Use small washers under the spikes on rough planks.	
21.	Use rings or spiral 6-in. spikes for fences, and 4-in. nails for gates.	

For more information on design of handling and housing facilities, see Alberta Agriculture and Food's *Corrals for Handling Beef Cattle* (Agdex 420/723-1).



Corner bracing.

# Pasture Fencing

## Types of Fences

Pasture fencing for a beef operation is used to contain cattle and to manage their grazing. The two most common types of fencing are barbed wire and high-tensile smooth wire. Electric fencing is also an option. Traditional barbed wire and

high-tensile smooth wire fences restrain animals by providing a physical barrier.

Electric fences use psychology to restrain animals. Animals fear that an electric fence will hurt them if it's touched, so they avoid contact with it. With proper installation and maintenance, any of these fence types contain grazing beef animals.

## Barbed Wire

Barbed wire fences have traditionally been used as pasture fencing. Typical construction (Figure 83) features three or four wires on posts that are spaced 10 to 16 ft. apart, depending on the topography. Barbed wire suspension fencing on flat topography can also be used (Figure 84).

Barbed wire fences provide a physical barrier, as the sharp barbs can be somewhat painful for animals that come in contact with the fencing. Barbed wire is also unpleasant for the fence builder.

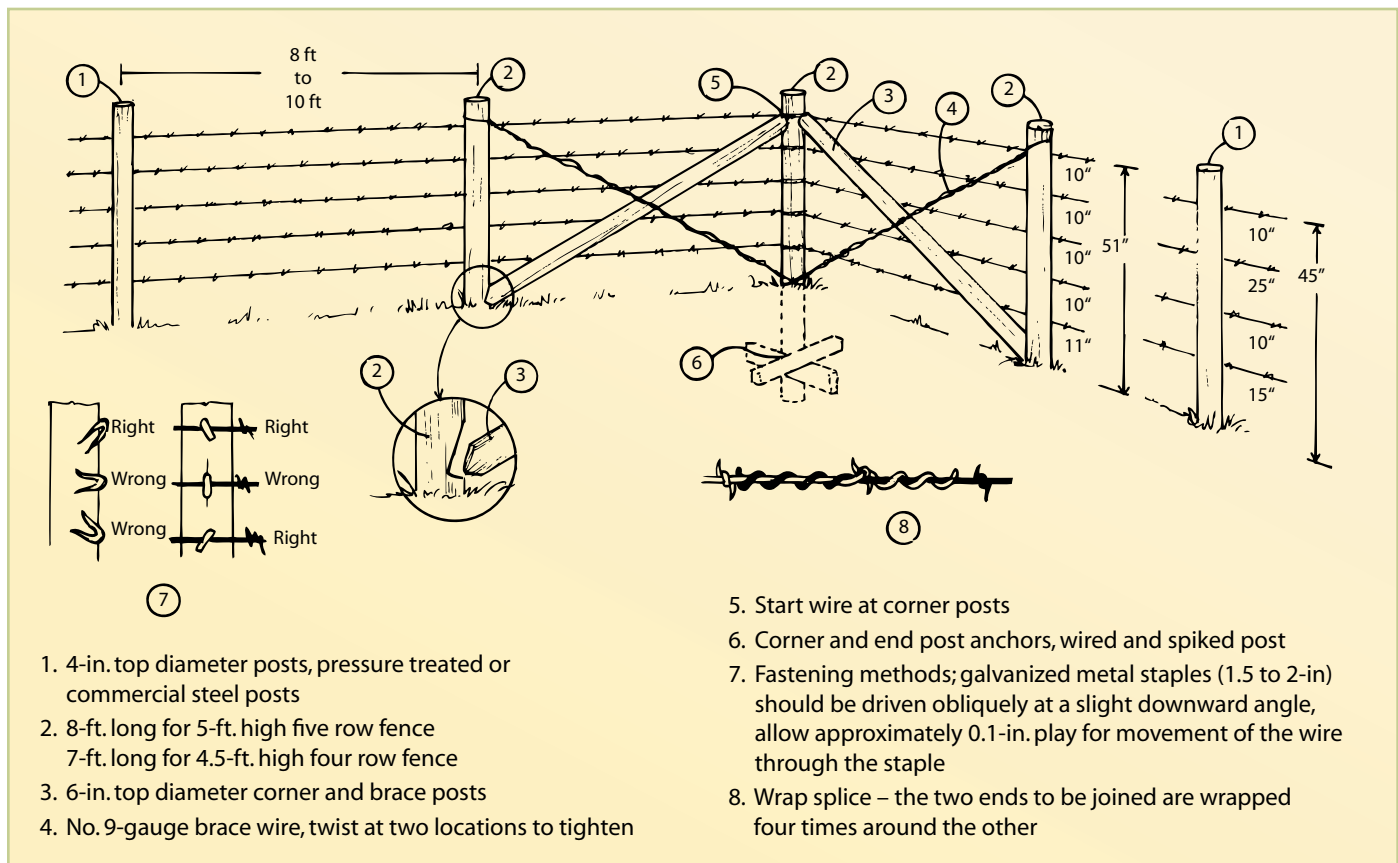
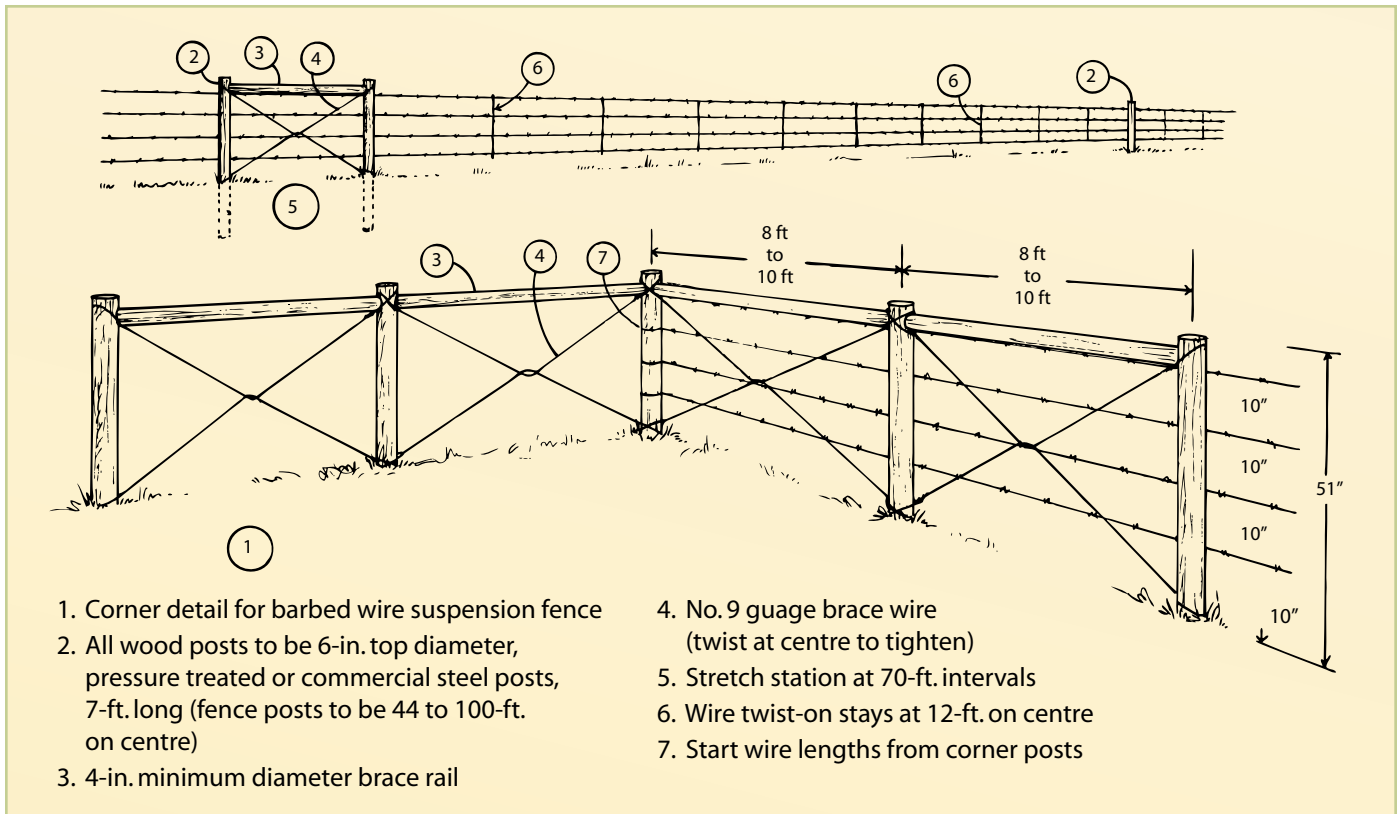
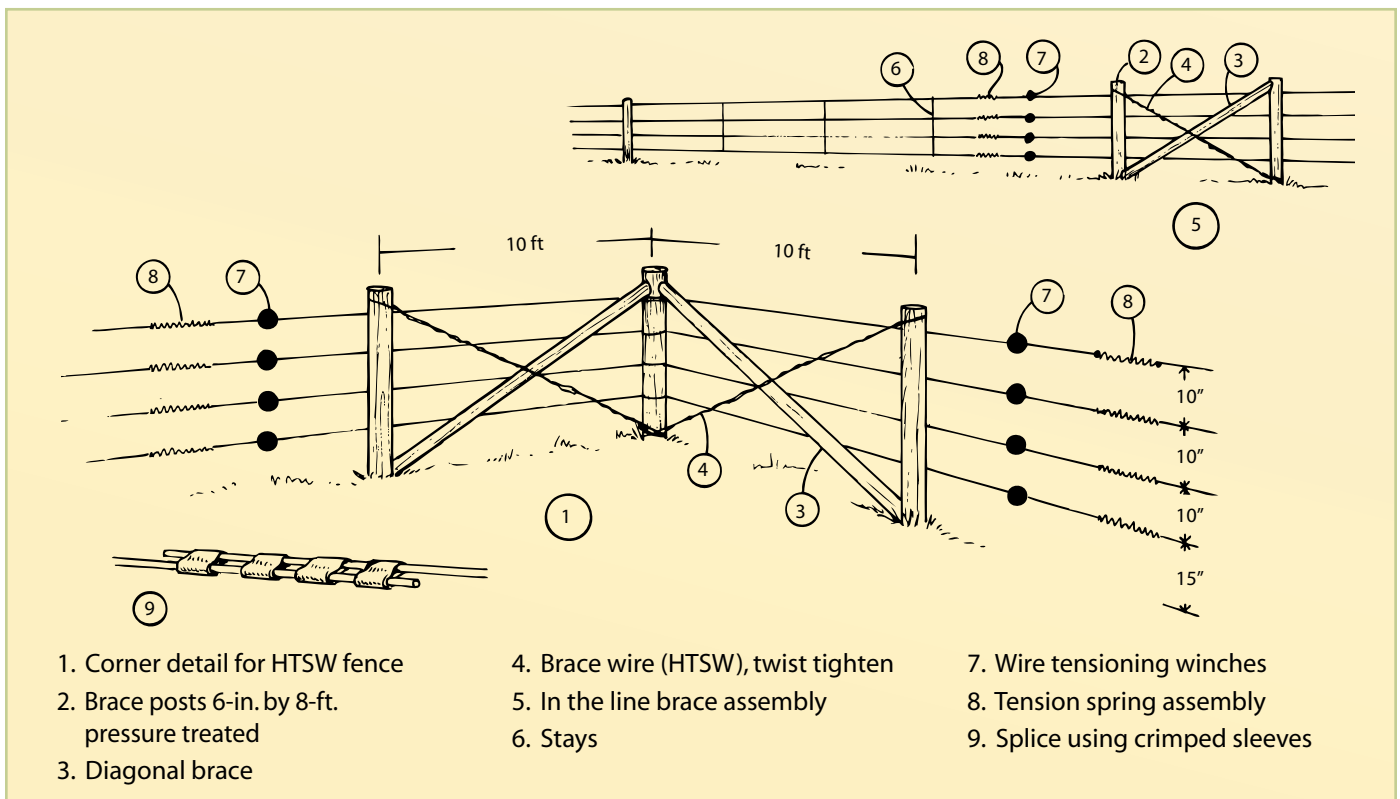


FIGURE 83. Barbed wire field fencing



**FIGURE 84.** Barbed wire suspension fencing



**FIGURE 85.** High-tensile smooth wire (HTSW) pasture fencing

TABLE 75. Spacing for high-tensile smooth wire fencing

Fencing Use	Number of strands	Height of top wire from ground (in.)	Wire spacing (in.)									
			Ground-1 <sup>st</sup> wire	1 <sup>st</sup> -2 <sup>nd</sup> wire	2 <sup>nd</sup> -3 <sup>rd</sup> wire	3 <sup>rd</sup> -4 <sup>th</sup> wire	4 <sup>th</sup> -5 <sup>th</sup> wire	5 <sup>th</sup> -6 <sup>th</sup> wire	6 <sup>th</sup> -7 <sup>th</sup> wire	7 <sup>th</sup> -8 <sup>th</sup> wire	8 <sup>th</sup> -9 <sup>th</sup> wire	9 <sup>th</sup> -10 <sup>th</sup> wire
Replaces 3 and 4-wire barbed wire	4	40	15	8	8	9	-	-	-	-	-	-
Pasture and range fences	4	46	15	10	10	11	-	-	-	-	-	-
Moderate to heavy grazing situations	5	45	16	7	7	7	8	-	-	-	-	-
	6	46	13	6	6	6	7	8	-	-	-	-
Contains small and large animals, discourages some wildlife and dogs	8	46	4	5	5	5	6	6	7	8	-	-
Replaces woven wire, contains most domestic livestock, discourages predators if 2 <sup>nd</sup> and 4 <sup>th</sup> wire electrified	10	47	4	4	4	4	5	5	5	5	5	5

### High-tensile Smooth Wire

High-tensile smooth wire is now readily available as an alternative material for fence construction. It is less costly, stronger, easier to handle and requires less maintenance than barbed wire. High-tensile smooth wire fencing may be installed as either an electrified or non-electrified type. When it is electrified, high-tensile fencing is usually considered permanent.

For an electrified high-tensile fence, one or two strands of wire are strung between posts located approximately 50 ft. apart. A non-electrified high-tensile fence consists of six to eight strands of wire with posts approximately 30 ft. apart, with stays at midpoints between the posts (Figure 85).

The posts are drilled for wires or the wires are staggered on alternate sides of the posts. They are spaced according to the fence uses outlined in Table 75. The minimum standard for high-tensile wire is 12.5-gauge high-tensile galvanized smooth wire, with a breaking load of 1,250 lb./ft. minimum and a tensile strength of 180,000 pounds per square inch (psi) minimum.

Tension each wire to 250 lbs. by using permanent in-line wire strainers or tensioning winches and install a tension spring assembly on each wire to handle the stretch in the line. Tension springs and in-line wire strainers should never be placed within the brace structures, but rather in mid span between the brace areas.

High-tensile suspension fences are most effective on level land and they have limited application on rough land. On rough or hilly land, the space between the posts should be shortened up to around 12 to 16 ft. apart, depending on the location on slope (Figure 86).

### Electric

Electric fences can be either permanent or temporary. Permanent electric fences are used for boundary fences and predator control. Temporary electric fences are used to confine animals to one area of the pasture in order to set up an intensive grazing management system. Electric fences may have one, two, three or more wires, depending on their function (Table 76). High-tensile wire pasture fences may be electrified to provide a higher level of pasture containment (Figure 87).





An electric fence will contain grazing beef animals if the animals are properly trained. The easiest way to train the cattle is to enclose them in a small, electrified corral and let them come in contact with a charged electric fence.

TABLE 76. Wire spacing for electrified fences

Fencing Use	Number of strands	Height of top wire from ground (in.)	Ground - 1 <sup>st</sup> wire	Wire spacing (in.)		
				1 <sup>st</sup> -2 <sup>nd</sup> wire	2 <sup>nd</sup> -3 <sup>rd</sup> wire	3 <sup>rd</sup> -4 <sup>th</sup> wire
Single wire for subdividing pasture (cattle without calves)	1	30	30	-	-	-
Two-wire subdivision fence for confining cattle with calves	2	36	20	16	-	-
Three-wire subdivision fence for rotational grazing and pasturing different kinds of livestock	3	36	13	11	12	-
Four-wire subdivision fence for rotational grazing and pasturing	4	36	6	7	10	12

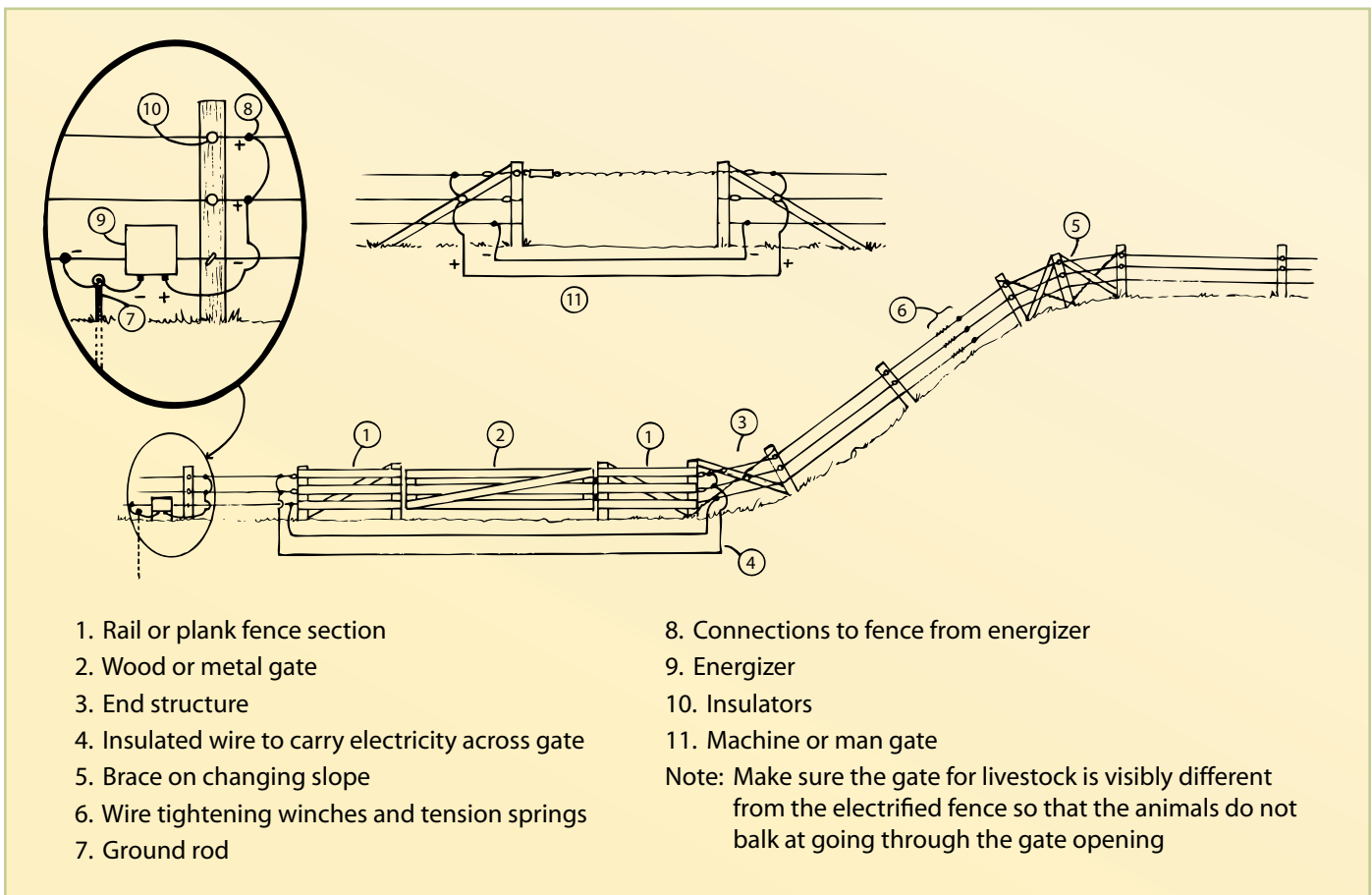


FIGURE 88. Permanent electric fence

Most animals are curious and when confined to a small area they are more than likely to touch the wire, get a shock and learn to avoid wire contact. Cattle usually require two to three days for training.

Once trained, animals shy away from electrified fences. They will even hesitate to cross where electrified fences once were. When installing a gate in an electric fence, make sure that the animals are able to visibly distinguish the difference between the gate and the fence (Figure 88). For example, a plank or metal gate can be used in a short section of plank fence. Another alternative is a lightweight gate made of plastic snow fence. Undergate cables are used to maintain a continuous charge to wires on either side of the gate. They are made from PVC conduit, complete with service entrance fittings. Insulated wire is run through pipe, connecting the charged wires on both sides of the gate.

It is recommended that all electric fences have warning signs posted at least every 300 ft.

## Fencing Materials

### Posts

Pressure-treated posts are recommended. Posts are used for corner and end braces, as well as line posts. Corners and end braces should be constructed of 6-in. top diameter posts. Line posts or pickets can be 3-in. diameter posts or larger. When constructing suspension fences, stays or droppers are used. Stays or droppers may be wood, metal or plastic.

### Wire

Barbed wire is available in two styles: single-strand high-tensile and two-strand. Never electrify a barbed wire fence as it does not conduct a charge.

High-tensile smooth wire is available in 100-lb. rolls in 12.5, 13 and 16.5-gauge. The 12.5-gauge wire is used for permanent high-tensile smooth wire fences. The 13 and 16.5-gauge wires are used for temporary and electrified fencing. Special lightweight conductors, made of wire and polypropylene with fine wires woven into them, are used for temporary electric fencing.



*Corner post with high-tensile smooth wire and crimping sleeves.*

## Fencing Hardware

Staples are used in the construction of both high-tensile smooth wire fences and barbed wire fences. Special staples are available that allow the smooth wire to slide in the staple. It is important to staple wire fences so that the wire can slide freely in the staple.

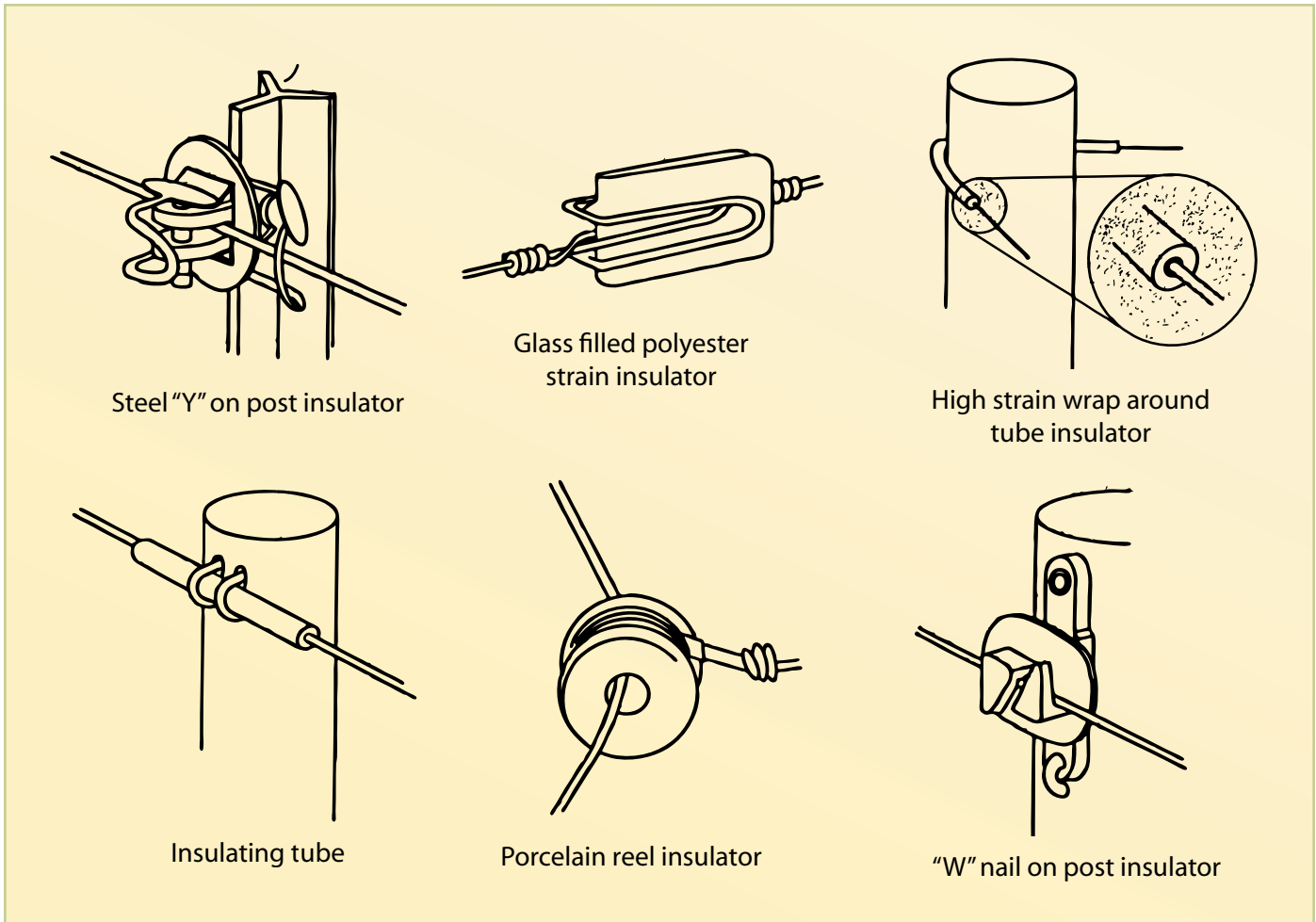
When building electric fences, the use of insulators where the wire joins to the posts is advisable, as it is possible to lose up to 1,100 volts through a wet post if insulators are not used. Figure 89 shows several different insulators available on the market.

## WIRE CONNECTIONS

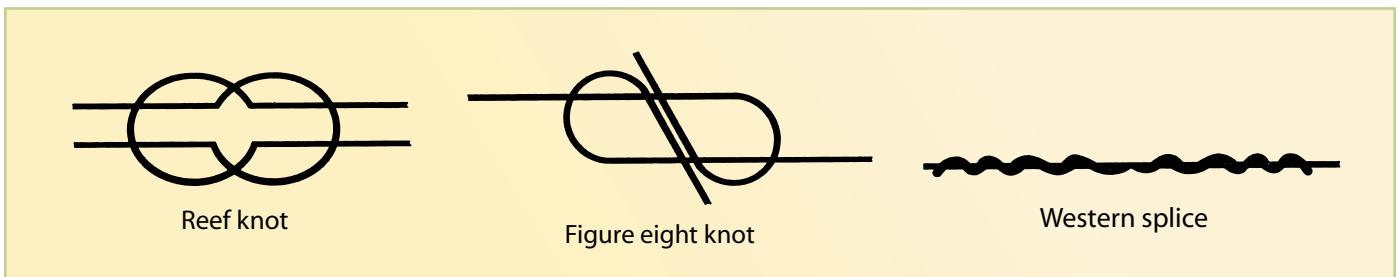
When joining wires, it is important to make a proper connection, especially in high-tensile and electric fences. The “reef knot” and the “figure-eight knot” are recommended (Figure 90). Wire splicing is done by using the “western union splice” or crimping sleeves and other special fittings.

A special crimping tool (Figure 91) is needed for correctly attaching crimping sleeves to the wires (Figure 92). Properly crimped wires are usually as strong as the wire itself. They are mainly used for connecting joints or tying off wire at end posts.

Line clamps and solderless clamps are easy to use and are a quick way to attach a lead-out wire to the live wires (Figure 92).

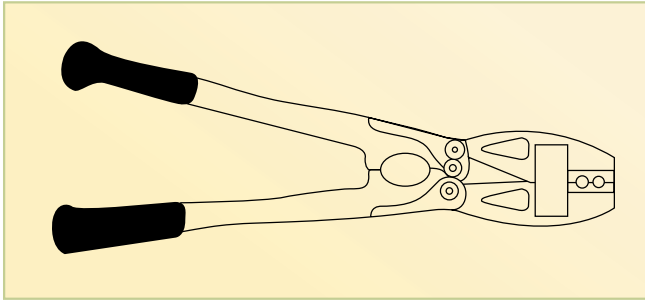


**FIGURE 89.** Types of insulators



**FIGURE 90.** Wire splices and knots





**FIGURE 91.** Crimping tool

To prevent corrosion at the joints, use a non-drying sealant and wrap the clamps with electrical tape. A “cold-galvanizing” paint can also be used.

Flexible connectors and cutout switches can be used to supply power to a section of a fence. They make it easy to disconnect fence sections from the main fence for troubleshooting and maintenance.

Gate handles (Figure 92) are spring-loaded plastic insulators, attached to gateposts. They allow you to safely open gates of electrified fences without receiving a shock.

### CONNECTING DISSIMILAR METALS

If it is necessary to connect dissimilar metals (e.g. copper and steel), special clamps and joint compounds are available. These products prevent massive corrosion at the joint, which would result in

a poor electrical connection (no current flow). Avoid using dissimilar metals in a fence because corrosion may occur even when joints are properly made.

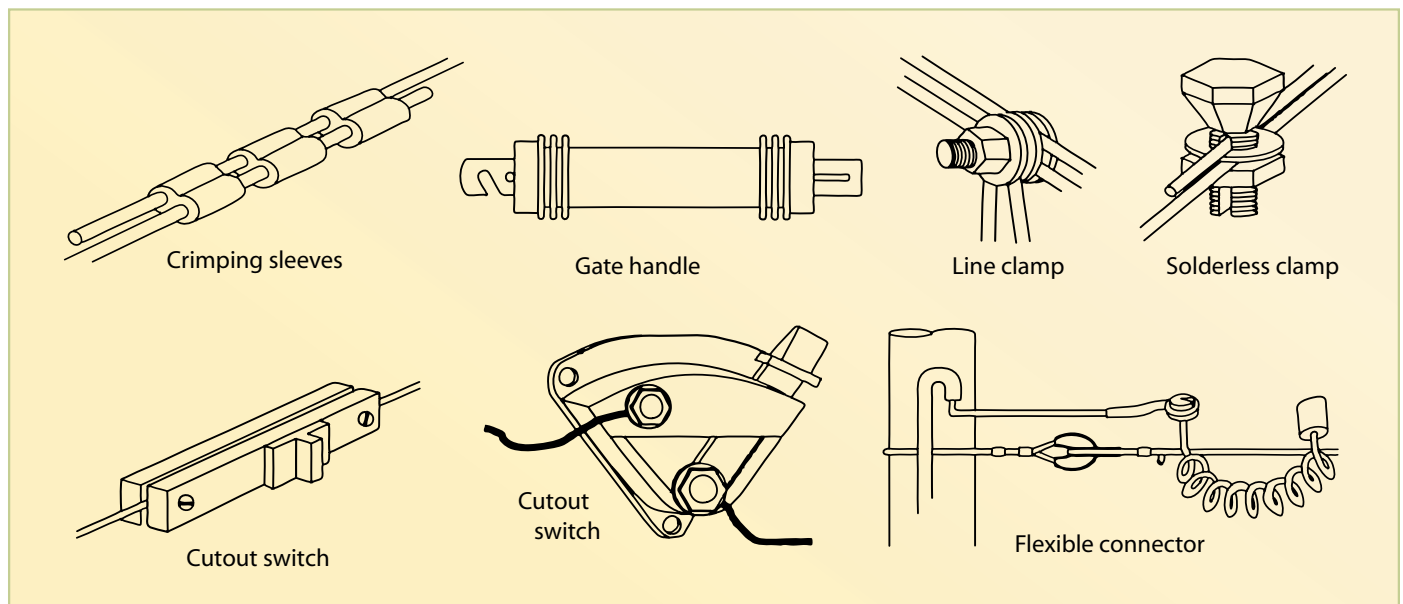
### ELECTRIC FENCE CONTROLLERS

Electric fence controllers generate a high current, short duration pulse of electrical energy. The pulse of electricity energizes the fence and makes it a psychological barrier to livestock. On some electric fence controllers, the pulse duration and timing can be adjusted. All electric fence controllers sold in Canada must meet Canadian Standards Association standard C22.2 No. 103-M1983 and subsequent amendments.

Electric fence controllers may be operated from 120-volt power sources, either battery powered or solar powered. Most electric fence controllers are rated by length in kilometres of single-wire fence that can be energized by the controller. For multiple-wire applications, divide the rated length of fence by the number of strands to be energized.

### Fencing Practice

Fences are made up of many components: corner structures, end braces, gates, posts, wire and other hardware. Single and double corner structures and end braces are constructed of 6-in. by 8-ft. posts driven 3 ft. into the ground.



**FIGURE 92.** Gate handles, connection clamps, cutout switches

For a stronger corner or brace, posts are driven to lean away from the pull of the wire. It is important to remember that the fence is only as strong as the end brace. Well-constructed, double end braces, as shown in Figure 83, 84 and 85 are highly recommended.

The post spacing between end or corner structures depends on the type of fence and the terrain. In non-suspension fences, 3 to 4-in. diameter posts are spaced 15 to 20 ft. apart. Suspension fences have posts spaced up to 50 ft. apart and droppers or stays every 10 ft. Electrifying a smooth wire fence allows the post spacing to be

increased up to 50 ft. and the droppers may be eliminated. In rolling or uneven terrain, the post spacing is reduced. In-line brace assemblies, placed at major changes in slope, make for a stronger fence by reducing the uplift forces on the posts.

Breaking electrical conductivity and grounding a fence reduces livestock losses from lightning strikes that hit a fence miles away. Fences should be grounded every 165 ft. in dry soils and every 300 ft. in wet soils. Grounding is done by driving a galvanized steel rod or pipe 6 ft. into clay soils or 10 ft. into sand or gravel. In addition, electrical conductivity of the wire should be broken every 1,650 ft.

Most electric fence energizers have built-in lightning protection. Damage can still result if lightning strikes, so an optional diverter and ground are recommended.

*An example of smooth wire electric fencing.*



## Electric Fence Safety and Maintenance

- Always turn the electric fence energizer off before servicing the fence, or provide plenty of cutout switches.
- Use only one electric fence energizer at a time.
- When testing an electric fence with a voltmeter, wear rubber gloves or rubber soled shoes to minimize any electrical shocks.
- Wet, sweaty hands and feet intensify electrical shocks.
- Be careful when working around overhead or underground powerlines.
- Do not work or stand beside a fence during an electrical storm.
- Never grasp an electric fence with a closed hand.
- Place warning signs at least every 300 ft. along an electric fence.
- Never attempt to service an electric fence energizer. If it fails, send it to the manufacturer for servicing.

- Keep all electrified wires tight and free of fallen trees and debris.
- All electric fences require regular maintenance.
- Check the voltage daily.
- Visually inspect the fence on a regular basis.
- Look for broken wires, broken insulators, loose wires and any object that may have fallen across the fence.
- Thoroughly check the fence after rainy or stormy weather.
- Fenceline maintenance is important.
- Remove all vegetation that could come in contact with the fence.
- Any vegetation that contacts live wires allows electrical current to go to the ground, reducing the fence's effectiveness.
- Control vegetation with herbicides or by mowing.

## Summary

Well-constructed and functional handling facilities contribute much to the easy, safe and rapid handling of cattle. The design of these facilities involves determining the required space, shelter, feed, water, waste management and livestock handling features. Then, the layout of the facilities needs to be adapted to the natural features of the site and organized for efficient and easy operation.

The main components of a handling system are: a holding corral; a crowding pen and gate; sorting corrals and gates; a working chute and gates; a loading chute and alley; a squeeze and veterinarian gate; a scale; and, hospital or sick pens.

Producers need to carefully consider and plan the dimensions and placement of each of these. The detailed recommendations for dimensions and layout in this chapter can help producers develop handling facilities that meet the needs of their operation.

Good planning of housing facilities can reduce labour, save time and feed, and keep capital costs to a minimum. Windbreaks and/or open-front sheds usually give adequate protection. For winter and early spring calving, a clean, dry, draft-free area is desirable when the weather is very cold or inclement.

The two most common types of pasture fencing are barbed wire and high-tensile smooth wire. Barbed wire fences have traditionally been used as pasture fencing. High-tensile smooth wire is less costly, stronger and easier to work with than barbed wire. It is also readily available. High-tensile smooth wire can be used for electric fencing; barbed wire cannot.

Fences are made up of many components: corner structures, end braces, gates, posts, wire and other hardware. The number of wire strands and the wire spacing depend on the wire type and the fence's purpose. Fence post spacing depends on the type of fencing and the terrain.

Sturdy, safe fencing depends on the materials selected, construction and maintenance. Safety precautions and regular fence and fenceline maintenance are especially important for electric fences.






 A photograph of a herd of beef cattle in a field. The cattle are of various colors, including black, brown, and white. They are standing in a field of tall, dry grass. In the background, there are rolling hills and trees under a clear blue sky.
 

Beef

# Information on the Internet

Since information is changing at a faster pace than ever before, this chapter provides a sample listing of Internet websites that provide information on a variety of beef cattle topics. More information on a specific topic can be researched by using the Internet. If you are searching for information on a certain subject, use the search feature of your Internet browser and type in the subject or company name to find a website.

## Canadian Cattle Organization and Association Sites

**Alberta Beef Producers**  
<http://www.albertabeef.org/>

**Alberta Farm Animal Care (AFAC) Association**  
<http://www.afac.ab.ca/>

**Beef Cattle Info Zone**  
<http://www.cattle.ca/index.htm>  
*Contains links to all of the National Beef Associations*

**Canadian Cattle Identification Agency**  
<http://www.canadaid.com/>

**Canadian Cattle Identification Agency, Producer Validation site**  
<https://www.clia.livestockid.ca/CCIARG/>

**Canadian Cattlemen's Association**  
<http://www.cattle.ca/ccca%20home.htm>

**Canadian Cattlemen's Association, BSE Update site**  
<http://www.info-cca.ca/>

**Canadian Organic Livestock Association Inc.**  
<http://www.colabeef.ca/>

## Federal and Provincial Government Beef Sites

**Agriculture and Agri-Food Canada**  
[http://www.agr.gc.ca/index\\_e.phtml](http://www.agr.gc.ca/index_e.phtml)

**Alberta Agriculture and Food, Beef section**  
<http://www.agric.gov.ab.ca/app21/seltopic?cat1=Livestock&cat2=Beef>

**Canadian Food Inspection Agency**  
<http://www.inspection.gc.ca/english/toce.shtml>

**ForageBeef.ca**  
[http://www.foragebeef.ca/app33/foragebeef/index\\_dial.jsp](http://www.foragebeef.ca/app33/foragebeef/index_dial.jsp)

*This site was developed by Alberta Agriculture and Food and Agriculture and Agri-Food Canada.*

**Manitoba Agriculture and Food, Beef section**  
<http://www.gov.mb.ca/agriculture/livestock/beef/index.html>

**Ontario Ministry of Agriculture, Food and Rural Affairs**  
<http://www.omafra.gov.on.ca/>

**Saskatchewan Agriculture and Food, Beef section**  
[http://www.agr.gov.sk.ca/level\\_4.asp?lev=4&cat=98](http://www.agr.gov.sk.ca/level_4.asp?lev=4&cat=98)

## United States Government Beef Sites

**United States Department of Agriculture (USDA)**  
<http://www.usda.gov/wps/portal/usdahome>

**USDA Animal and Plant Health Inspection Service**  
<http://www.aphis.usda.gov/>

**USDA Animal Welfare Information Center**  
<http://www.nal.usda.gov/awic/>

**USDA Center for Animal Health Monitoring (CAHM)**  
<http://www.aphis.usda.gov/vs/ceah/ncahs/index.htm>

## Other Cattle Organization and Association Sites

**National Cattlemen's Beef Association**  
<http://www.beef.org>

**Texas State Cattle Raisers Association**  
<http://www.texascattleraisers.org/Default.htm>

## General Beef Cattle Information Sites

**Beef**  
<http://industryclick.com/magazine.asp?magazineid=13&SiteID=5>

**Cowtown**  
<http://www.cowtown.org/>

**Farm Journal - Beef Today magazine**  
<http://www.agweb.com/beeftoday.asp>

**Feedstuffs, The Weekly Newspaper for Agribusiness**  
<http://www.feedstuffs.com/ME2/default.asp>

**North Dakota State University, Agricultural Research**  
<http://www.ag.ndsu.nodak.edu/>

**Oklahoma Cooperative Extension Service, Cow-Calf Corner**  
<http://cowcalfcorner.okstate.edu/>

**University of Nebraska, Department of Animal Science, Beef Cattle section**  
<http://www.animalscience.unl.edu/document.cgi?docID=52>

**University of Nebraska, Nebraska Extension Beef Publications**  
<http://ianrpubs.unl.edu/beef/>

## Range, Pasture and Grazing Information Sites

**Agriculture and Agri-Food Canada, Canadian Poisonous Plants Information System**  
[http://www.cbif.gc.ca/pls/pp/poison?p\\_x=px](http://www.cbif.gc.ca/pls/pp/poison?p_x=px)

**Alberta Sustainable Resource Development, Public Lands, Range Management Division**  
<http://www.srd.gov.ab.ca/land/index.html>

*This site provides information on range management, classification, assessment and grazing cattle management.*

### **Cows and Fish**

<http://www.cowsandfish.org/index.html>

*This site provides riparian grazing management information.*

### **National Sustainable Agriculture Information Service**

<http://attra.ncat.org/livestock.html#Beef>

*This site provides information and other technical assistance on sustainable agriculture in the United States. The resources deal with sustainable livestock production, literally from the ground up.*

### **Western Beef Development Centre**

<http://www.wbdc.sk.ca/index.htm>

## **Genetics and Breeding Information Sites**

### **Cattleland Feedyards**

<http://www.cattlelandfeedyards.com/>

*Cattleland Feedyards conducts national bull testing evaluations and net feed efficiency testing of bulls.*

### **Crossbreeding Programs**

<http://www.redangus1.org/newredsite/crossbreedingprograms/crossbreed.html>

### **Effective Use of Artificial Insemination in Beef Cattle**

<http://www.msue.msu.edu/msue/imp/modaa/16360001.html>

### **Oklahoma State University, Animal Science Department, Cattle Breeds**

<http://www.ansi.okstate.edu/breeds/cattle/>

### **United States Meat Animal Research Center**

<http://www.marc.usda.gov/>

## **Animal Health Information Sites**

### **Alberta Veterinary Medical Association**

<http://www.avma.ab.ca/>

### **Cowdoc.net**

<http://www.Cowdoc.net/>

*This site is based in England and discusses cattle health and welfare issues.*

### **Implant database**

<http://idb.asft.ttu.edu/dbhome/default.htm>

### **NetVet**

<http://netvet.wustl.edu/>

*This site is based in the United State and deals with animal health information.*

### **United Kingdom, Department for Environment, Food and Rural Affairs, Animal Health and Welfare**

<http://www.defra.gov.uk/animalh/animindx.htm>

## **Quality Assurance Programs**

### **Alberta Beef On-Farm Food Safety**

<http://www.beefsafety.ab.ca/index.shtml>

*This site introduces the Alberta on-farm food safety program and how to take part in it as an Alberta beef cattle producer.*

### **Beef Quality Assurance Program (United States)**

<http://beefusa.org/>

### **Canadian Cattlemen's Association, Quality Starts Here Program**

<http://www.cattle.ca/qsh/qsh/default.htm>

### **Canadian On-Farm Food Safety Program**

<http://www.cfa-fca.ca/pages/>

### **Montana Beef Network, Beef Quality Assurance**

<http://www.montana.edu/wwwmbu/BQA.html>

### **Montana State University, Montana Beef Network**

<http://www.mbn.montana.edu/>

### **Texas Beef Quality Producer Program**

<http://www.texasbeefquality.com/>

## **Research and Consumer Information Sites**

### **Agriculture and Agri-Food Canada, Lacombe Research Centre**

[http://res2.agr.ca/lacombe/index\\_e.htm](http://res2.agr.ca/lacombe/index_e.htm)

### **Agriculture and Agri-Food Canada, Lethbridge Research Centre**

[http://res2.agr.ca/lethbridge/index\\_e.htm](http://res2.agr.ca/lethbridge/index_e.htm)

### **Beef Information Centre**

<http://www.beefinfo.org/>

### **Certified Angus Beef Program**

<http://www.cabprogram.com/>

### **Highland Feeders**

<http://www.highlandbeef.com/>

*This site provides information on Highland's value chain and Spring Creek Ranch Premium Natural Beef.*

### **Laura's Lean Beef**

<http://www.laurasleanbeef.com>

### **Western Beef Development Centre**

<http://www.wbdc.sk.ca/>

## **Economic and Market Information Sites**

### **Alberta Agriculture and Food, Cow-Calf Enterprises, Economic and Financial Information**

[http://www1.agric.gov.ab.ca/\\$department/deptdocs.nsf/all/econ8479](http://www1.agric.gov.ab.ca/$department/deptdocs.nsf/all/econ8479)

### **CanFax**

<http://www.canfax.ca>

### **Cattle Buyers Weekly**

<http://www.cattlebuyersweekly.com/>

### **Western Extension Marketing Committee, Managing for Today's Cattle Market and Beyond**

<http://ag.arizona.edu/arec/wemc/TodaysCattlePub.html>

## **Cattle Facilities and Handling Behaviour Information Sites**

### **Alberta Society for the Prevention of Cruelty to Animals (SPCA)**

<http://www.albertaspca.org/>

### **Canada Plan Service**

<http://www.cps.gov.on.ca/english/planmenu.htm>

*This site provides beef cattle housing and equipment plans that can be downloaded.*

### **Dr. Temple Grandin's web page**

<http://www.grandin.com/>

*This site contains research information and articles on livestock behaviour, handling and humane slaughter by Dr. Temple Grandin.*

## **Computer Software for Cattle Operations**

### **Brisco Charolais and Brisco Software**

<http://www.brisco.net/index.html>

*This site provides the Brisco beef herd records management program (for purebred herds and commercial herds) and Brisco accounting system software.*

### **CattlePro™**

<http://www.cattlepro.com/>

### **Cow Herd Appraisal Performance Software**

<http://www.chaps2000.org/>

*This program is available in Canada from the Western Beef Development Centre at <http://www.wbdc.sk.ca/>.*

### **Cow Sense® Herd Management Software for Beef Herd Improvement**

<http://www.midwestmicro.com/>

### **CowBytes® Ration Balancing Program**

[http://www1.agric.gov.ab.ca/\\$department/deptdocs.nsf/all/hst842](http://www1.agric.gov.ab.ca/$department/deptdocs.nsf/all/hst842)

### **CowProfit\$®**

[http://www1.agric.gov.ab.ca/\\$department/deptdocs.nsf/all/hst885?opendocument](http://www1.agric.gov.ab.ca/$department/deptdocs.nsf/all/hst885?opendocument)

### **Feeder Profit\$®**

[http://www1.agric.gov.ab.ca/\\$department/deptdocs.nsf/all/hst9300](http://www1.agric.gov.ab.ca/$department/deptdocs.nsf/all/hst9300)

### **Farmcentre.com**

<http://www.farmcentre.com/english/farmsoftware/start.htm>

### **Hi-Plains Systems Inc., Livestock Software**

<http://www.hiplainsystems.com/index.html>





# References

**Allen, W. M. and Sansom, B. F. 1993.** Parturient paresis (milk fever) and hypocalcemia (cows, ewes and goats). Pages 304-309 *in* J. L. Howard, ed. Current veterinary therapy - food animal practice. WB Saunders, Philadelphia, PA.

**Anderson, P. T. and Botts, R. L. 1995.** Effects of steroid implants on feed intake. Pages 97-104 in Symposium: Intake by Feedlot Cattle. Oklahoma Agricultural Experiment Station, Oklahoma State University, Stillwater, OK.

**Anonymous. 1985.** Beef cattle report. University of Nebraska Extension, University of Nebraska, Lincoln, NE.

**Block, H. C., McKinnon, J. J., Mustafa, A. F. and Christensen, D. A. 2001.** Manipulation of cattle growth to target carcass quality. *J. Anim. Sci.* 79: 133-140.

**Borg, R., Tucker, S., Williamson, K., Yurchak, T., Ziegler, K. and ZoBell, D. 1993.** Corrals for handling beef cattle. Agdex 420/723-1. Alberta Agriculture and Food, Edmonton, AB.

**Call, J. W., Butcher, J. E., Blake, J. T., Smart, R. A. and Shupe, J. L. 1978.** Phosphorus influence on growth and reproduction of beef cattle. *J. Anim. Sci.* 47: 216-225.

**Call, J. W., Butcher, J. E., Shupe, J. L., Blake, J. T. and Olson, A. E. 1986.** Dietary phosphorus for beef cows. *Am. J. Vet. Res.* 47: 475-481.

**Canada Plan Service Plan. 1984.** M1800 Cattle handling facilities. [Online] Available: <http://www.cps.gov.on.ca/english/plans/E1000/1800/M-1800L.pdf>

**Canada Plan Service Plan. 1984.** M1000 Beef cattle housing and equipment. [Online] Available: <http://www.cps.gov.on.ca/english/plans/E1000/1000/1000L.pdf>

**Canadian Food Inspection Agency. 2005.** Canadian Food Inspection Agency's (CFIA) Feed Ban. [Online] Available: <http://www.inspection.gc.ca/english/anima/feebet/rumin/ruminfse.shtml>

- Cheeke, P. R. 1998.** Natural toxicants in feeds, forages and poisonous plants. Department of Animal Sciences, Oregon State University, Interstate Publishers, Inc., Danville, Illinois.
- Colwell, D. D. 2000.** Lice management for feedlot cattle. Pages S2W1:1-7 *in* T. Marx, R. Hand and D. Engstrom, eds. Alberta feedlot management guide. 2nd ed. Prolivestock, Calgary, AB.
- Coulter, G. H., Mapletoft, R. J., Kozub, G. C. and Cates, W. F. 1987.** Scrotal circumference of two-year-old bulls of several beef breeds. *Theriogenology* 27: 485-491.
- Dorin, C. 2000.** Growth implant strategies. Pages 1U1:1-12 *in* T. Marx, R. Hand and D. Engstrom, eds. Alberta feedlot management guide. 2nd ed. Prolivestock, Calgary, AB.
- Doyle, E. 2000.** Human safety of hormone implants used to promote growth in cattle – A review of the scientific literature. Food Research Institute, University of Wisconsin, Madison, WI.
- Duckett, S. K., Owens, F. N. and Andrae, J. G. 1997.** Effects of implants on performance and carcass traits of feedlot steers and heifers. Pages 63–82 *in* F.M. Owens, ed. Impact of implants on performance and carcass value of beef cattle. Oklahoma Agricultural Experiment Station, Oklahoma State University, Stillwater, OK.
- Faulkner, D. B., Eurell, T., Tranquilli, W. J., Ott, R. S., Ohl, M. W., Cmakrik, G. F. and Zinn, G. 1992.** Performance and health of weanling bulls after butorphanol and xylazine administration of castration. *J. Anim. Sci.* 70: 2970-2974.
- Fisher, A. D., Crowe, M. A., Alonso de la Varaga, M. E. and Enright, W. J. 1996.** Effect of castration method and the provision of local anesthesia on plasma cortisol, scrotal circumference, growth and feed intake of bull calves. *J. Anim. Sci.* 74: 2336-2343.
- Horst, R. L., Goff, J. P., Reinhardt, T. A. and Buxton, D. R. 1997.** Strategies for preventing milk fever in dairy cattle. *J. Dairy Sci.* 80: 1269-1280.
- Houghton, P. L., Lemenagere, R. R., Horstman, L. A., Hendrix, K. S. and Moss, G. E. 1990.** Effects of body composition, pre- and postpartum energy level and early weaning on reproductive performance of beef cows and preweaning calf gain. *J. Anim. Sci.* 68: 1438-1446.
- Kahn, C. M. (ed.) 2006.** The Merck veterinary manual. 9th ed. Merck & Co., Whitehouse Station, NJ. [Online] Available: <http://www.merckvetmanual.com/mvm/index.jsp>
- Kemp, A. and 't Hart, M. L. 1957.** Grass tetany in grazing milking cows. *Neth. J. Agric. Sci.* 5: 4-17.
- Kroker, G. A. and Cummins, L. J. 1979.** The effect of nutritional restriction on Hereford heifers in late pregnancy. *Australian Vet. J.* 55: 467-474.
- Majak, W., McAllister, T. A., McCartney, D., Stanford, K. and Cheng, K.-J. 2003.** Bloat in cattle. *Agdex 420/60-1.* Alberta Agriculture and Food, Edmonton, AB.
- Martin, J., Hudson, R. J., Young, R. R. A. and Young, B. A. 1993.** Animal production in Canada. Faculty of Extension, University of Alberta, Edmonton, AB.
- McKinnon, J. J. 1996.** Designing feedlot rations. *in* Manitoba Feedlot Days Proceedings. Manitoba Agriculture, Winnipeg, MB.
- McKinnon, J. J., Cohen, R. D. H., Jones, S. D. M., Laarveld, B. and Christensen, D. A. 1993.** Crude protein requirements of large-frame cattle fed two levels of energy as weaned calves or as backgrounded yearlings. *Can. J. Anim. Sci.* 73: 315-325.
- Minson, D. J. 1990.** Forages in ruminant nutrition. Academic Press, New York, NY.
- Montgomery, M. J. and Baumgardt, B. R. 1965.** Regulation of food intake in ruminants 2. Rations varying in energy concentration and physical form. *J. Dairy Sci.* 48: 1623.
- National Research Council. 2000 Update.** Nutrient requirements of beef cattle. 7th rev. ed. 1996. National Academy Press, Washington, DC.

**National Research Council. 2001.** Nutrient requirements of dairy cattle. 7th ed. National Academy Press, Washington, DC.

**Price, E. O., Harris, J. E., Borgwardt, R. E., Sween, M. L. and Connor, J. M. 2003.** Fenceline contact of beef calves with their dams at weaning reduces the negative effects of separation on behaviour and growth rate. *J. Anim. Sci.* 81: 116-121.

**Randel, R. D. 1990.** Nutrition and postpartum rebreeding in cattle. *J. Anim. Sci.* 68: 853-862.

**Sasser, G. E., Williams, R. J., Bull, R. C., Ruder, C. A. and Falk, D. G. 1989.** Postpartum reproductive performance in crude protein restricted beef cows: return to estrus and conception. *J. Anim. Sci.* 66: 3033.

**Sumption, L. J. 1977.** Building new breeds, our most underutilized animal production resource. *Beef Cattle Science Handbook* 14: 146-148.

**United Kingdom Department of Environment, Food and Rural Affairs. 2004.** BSE: Science & research - What is BSE? [Online] Available: <http://www.defra.gov.uk/animalh/bse/science-research/bse.html>

**United States Department of Agriculture (USDA). 1973 - 1977.** Meat Animal Research Center Annual Reports, Agricultural Research Service, Meat Animal Research Center, Clay Center, Nebraska.

**Van Donkersgoed, J. 2000.** Liver abscesses. Page 5H1:1 *in* T. Marx, R. Hand and D. Engstrom, eds. Alberta feedlot management guide. 2nd ed. Prolivestock, Calgary, AB.

**Van Soest, P. J. 1994.** Nutritional ecology of the ruminant. 2nd ed. Cornell University Press, Ithaca, NY.

**Van Vleck, L. D. and Cundiff, L. V. 1998.** Sex effects on breed of sire differences for birth, weaning and yearling weights. *J. Anim. Sci.* 76: 1528-1534.

**Walton, P. D. 1983.** The production and management of cultivated forages. Reston Publishing Co. Inc., Reston, Virginia.

**Western Forage/Beef Group (WFBG). 2005.** Wastage from feeding on the ground. WFBG Newsletter 9(2): 5.

**Wiltbank, J. N. 1967.** Fertility in beef cows bred to produce straightbred and crossbred calves. Reproductive performance in the United States. *J. Anim. Sci.* 26: 1005-1110.

**Wiltbank, J. N. 1970.** Research needs in beef cattle reproduction. *J. Anim. Sci.* 42: 755.

**Wiltbank, J. N. 1978.** Unpublished data, Texas Agric. Exp Station, College Station, TX.

**Wiltbank, J. N., Rowden, U. N. and Ingalls, J. E. 1965.** Relationship between measures of semen quality and fertility in bulls mated under natural conditions. *University of Nebraska Bulletin* 24: 3-19.

**Zollinger, W. A. and Carr, J. 2002.** How to select, grow and manage replacement heifers. Pages 745.1-745.5 *in* J. R. Adams, ed. Cow-calf management guide, cattle producer's library. 2nd ed. University of Idaho Extension, Moscow, ID.

**Zollinger, W. A., Farnsworth, G. and White, R. 2002.** Bull management and care in the Western United States during and after the breeding season. Pages 436.1-436.3 *in* J. R. Adams, ed. Cow-calf management guide, cattle producer's library. 2nd ed. University of Idaho Extension, Moscow, ID.









**AGDEX 420/10**

Printed in Canada